ONKYO

AV RECEIVER

TX-RZ830

Instruction Manual

Table of contents

Connections

- Connecting Speakers

Playback

Setup

Troubleshooting

Appendix

Supplementary Information



What's in the box	5
Part Names	6
Front Panel	6
Display	8
Rear Panel	9
Remote Controller	11

Connections

Connecting speakers	13
Speaker Installation	14
Speaker Connections and "Speaker Setup" Settings	40
Connecting a Power Amplifier	57
Speaker combinations	58
Connecting the TV	59
To ARC TV	60
To Non-ARC TV	61
Connecting Playback Devices	62
Connecting an AV Component with HDMI Jack Mounted	62
Connecting an AV Component without HDMI Jack Mounted	63
Connecting an Audio Component	64
Connecting a Video Camera, etc.	65

Connecting an AV Component in a Separate Room (Multi-zone Connection)	66
Connecting a TV (ZONE 2)	66
Connecting a Pre-main Amplifier (ZONE 2)	67
Connecting a Pre-main Amplifier (ZONE 3)	68
Connecting Antennas	69
Network Connection	70
Connecting External Control Devices	71
IR IN port	71
12V TRIGGER OUT jack	72
Connecting the Power Cord	73

Playback

AV Component Playback	75
Basic Operations	75
BLUETOOTH® Playback	76
Basic Operations	76
Internet Radio	77
Playing Back	77
Spotify	79
Playing Back	79
AirPlay®	80
Basic Operations	80
DTS Play-Fi®	81

Playing Back	81
FlareConnect™	82
Playing Back	82
USB Storage Device	83
Basic Operations	83
Device and Supported Format	85
Playing back files on a PC and NAS (Music Server)	86
Windows Media® Player settings	86
Playing Back	87
Supported Audio Formats	90
Play Queue	91
Initial Setup	91
Adding Play Queue Information	91
Sort and Delete	92
Playing Back	92
Listening To the AM/FM Radio	93
Tuning into a Radio Station	93
Presetting a Radio Station	95
Using RDS (European, Australian and Asian models)	97
Multi-zone	98
Switch remote control mode (ZONE 2)	99
Switch remote control mode (ZONE 3)	100
Playing Back	101

Convenience functions	103
Adjusting the tone	103
Sleep Timer	104
Listening Mode	105
Selecting a Listening mode	105
Listening Mode Effects	107
Selectable listening modes	112

Setup

Setup Menu	125
Menu list	125
Menu operations	127
1. Input/Output Assign	128
2. Speaker	132
3. Audio Adjust	138
4. Source	139
5. Hardware	141
6. Multi Zone	146
7. Miscellaneous	147
Quick Menu	148
Menu operations	148
Web Setup	150
Menu operations	150

Firmware Update	151
Updating Function on This Unit	151
Updating the Firmware via Network	152
Updating via USB	154
Initial Setup with Auto Start-up Wizard	156
Operations	156
Troubleshooting	
When the unit is operating erratically	160
Troubleshooting	161
Appendix	
About HDMI	170
General Specifications	172

What's in the box

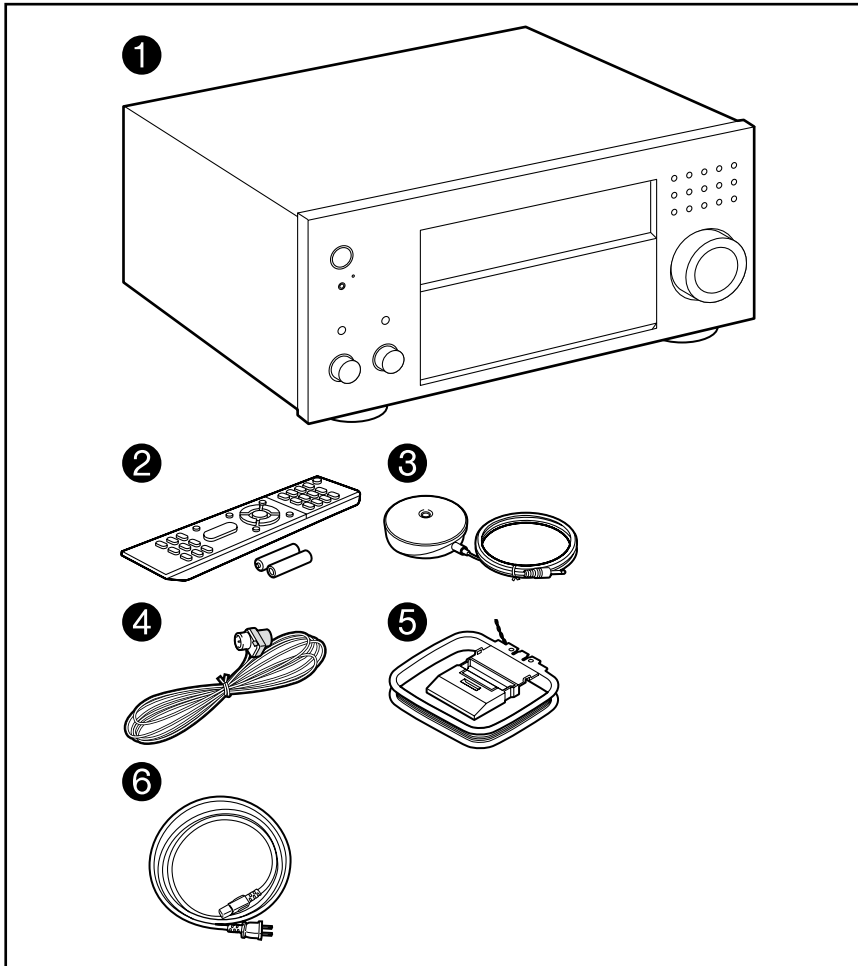

1. Main unit (1)
2. Remote controller (RC-911R) (1), Batteries (AAA/R03) (2)
3. Speaker setup microphone (1)
 - Used during Initial Setup.
4. Indoor FM antenna (1)
5. AM loop antenna (1)
6. Power cord (1)
 - Quick Start Guide (1)
 - * This document is an online instruction manual. It is not included as an accessory.
 - Connect speakers with an impedance of 4 Ω to 16 Ω.
 - The power cord must be connected only after all other connections are completed.
 - We will not accept any responsibility for damage arising from the connection with equipment manufactured by other companies.
 - Network services and content that can be used may no longer be available if new functions are added by updating firmware or the service providers terminate their services. Also, available services may differ depending on your area.
 - Details on the firmware update will be posted on our website and through other means at a later date.
 - Specifications and appearance are subject to change without prior notice.

Part Names

Front Panel

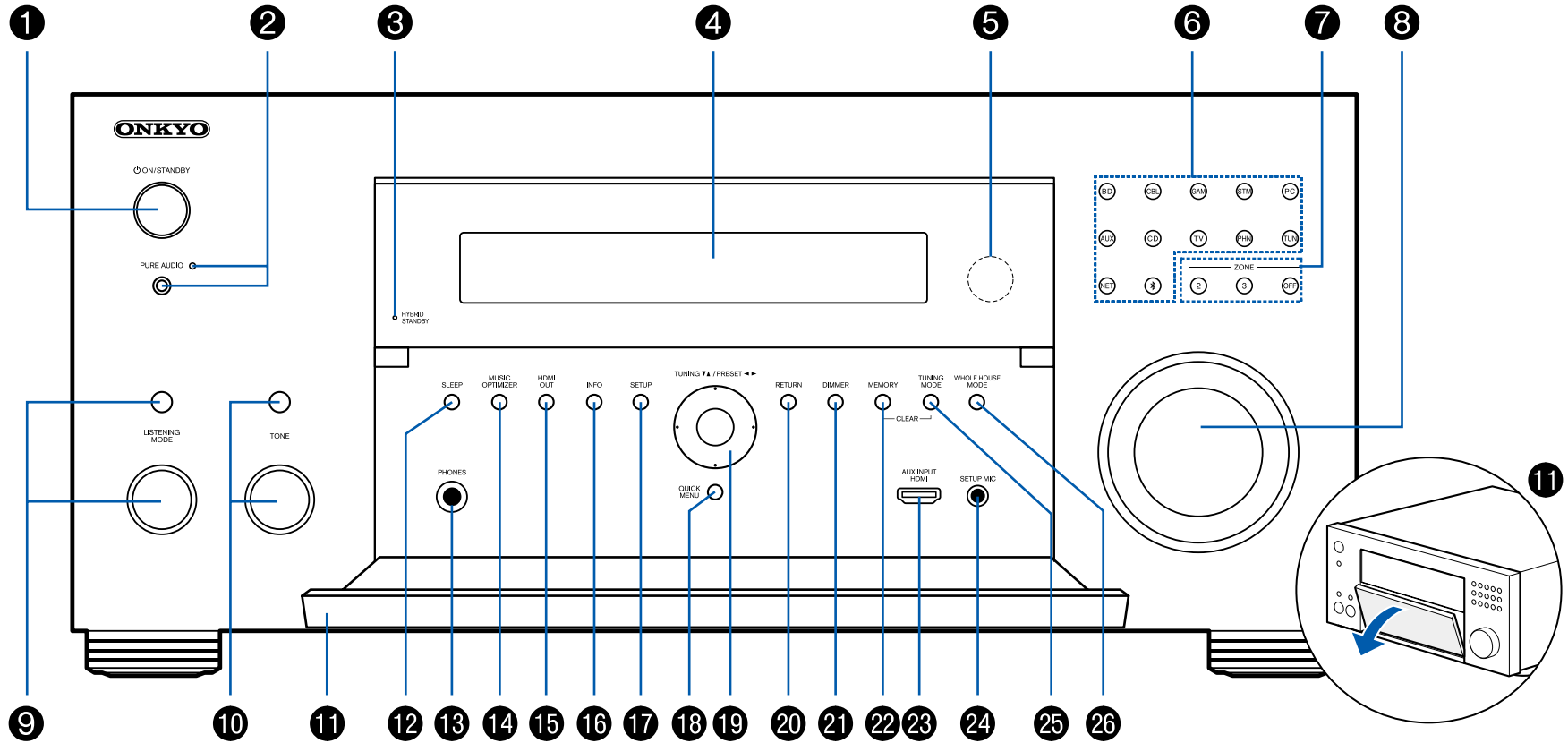

□ For details, see (→p7)

1. \odot ON/STANDBY button
2. PURE AUDIO button/indicator: Switches to the Pure Audio mode. (→[p109](#))
3. HYBRID STANDBY indicator: Lights if the unit enters standby mode when the functions such as HDMI Standby Through and Network Standby that work in standby are enabled.
4. Display (→[p8](#))
5. Remote control sensor: Receives signals from the remote controller.
 - The reception range of the remote controller is within a distance of approx. 16'5 m, and an angle of 20° in vertical direction and 30° to right and left.
6. Input selector buttons: Press the following buttons to switch the input to be played. The jack allocated to the buttons at the time of purchase, etc. are shown inside the parentheses ().

BD (BD/DVD)	CD (CD)
CBL (CBL/SAT)	TV (TV)
GAM (GAME)	PHN (PHONO)
STM (STRM BOX)	TUN: AM/FM Radio
PC (PC)	NET: Playing the Internet Radio, USB, etc.
AUX (AUX INPUT HDMI)	※ : BLUETOOTH function
7. ZONE 2/ZONE 3 button: Controls the multi-zone function. (→[p101](#))
 OFF button: Switches the multi-zone function off. (→[p101](#))
8. MASTER VOLUME
9. Press the LISTENING MODE button (above) to select a category from "Movie/TV", "Music" and "Game", and then turn the LISTENING MODE dial (below) to change the listening mode. (→[p105](#))
10. You can adjust the sound quality of the speakers. Press the TONE button (above) to select an item to adjust from "Bass" and "Treble", and turn the TONE dial (below) to adjust. (→[p103](#))
11. Front flap
12. SLEEP button: Sets the sleep timer. Select the time from "30 min", "60 min" and "90 min". (→[p104](#))
13. PHONES jack: Connect headphones with a standard plug ($\phi 1/4$ "/6.3 mm).
14. MUSIC OPTIMIZER button: Turns on/off the MUSIC OPTIMIZER function that improves the quality of the compressed audio.
15. HDMI OUT button: Select the HDMI OUT jack to output video signals. (→[p128](#))
16. INFO button: Switches the information on the display. (→[p106](#))
17. SETUP button: You can display advanced setting items on the TV and the display to have a more enjoyable experience with this unit. (→[p125](#))
18. QUICK MENU button: Pressing this button during playback can make settings such as "Tone" and "Level" quickly on the TV screen while playing.
19. Cursor buttons (\blacktriangle / \blacktriangledown / \blacktriangleleft / \blacktriangleright) and ENTER button: Select an item with the cursors, and press ENTER to confirm your selection. When using TUNER, use them to tune in to stations. (→[p93](#))
20. RETURN button: Returns the display to the previous state while setting.
21. DIMMER button: Switches the brightness of the display with three levels. It cannot be turned off completely.
22. MEMORY button: Used to register AM/FM radio stations. (→[p95](#))
23. AUX INPUT HDMI jack: Connect a video camera, etc. using an HDMI cable. (→[p65](#))
24. SETUP MIC jack: Connect the supplied speaker setup microphone. (→[p157](#))
25. TUNING MODE button: Used to switch between automatic tuning and manual tuning for AM/FM stations. (→[p93](#))
26. WHOLE HOUSE MODE button: Enable the WHOLE HOUSE MODE function to play the same source in all rooms that are multi-zone-connected. (→[p102](#))

Display

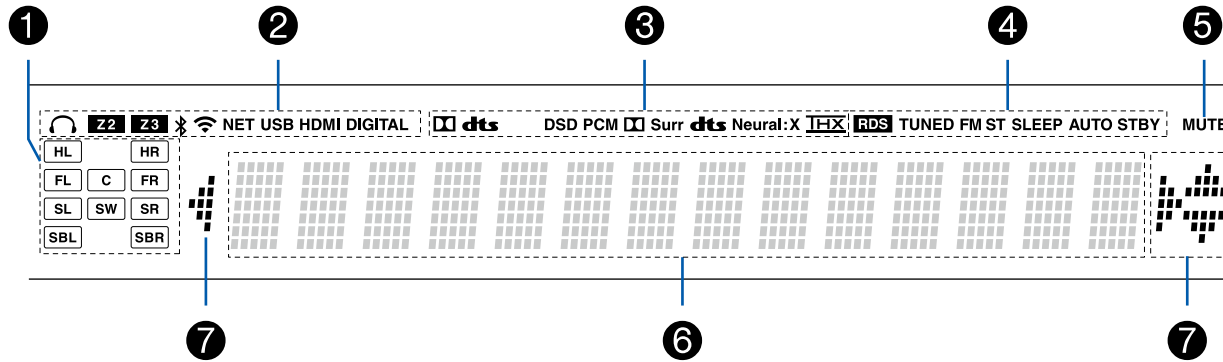

1. Speaker/Channel display: Displays the output channel that corresponds to the selected listening mode.
2. Lights in the following conditions.
 - 🎧: Headphones are connected.
 - Z2/Z3: ZONE 2/ZONE 3 is on.
 - 📶: Connected by BLUETOOTH.
 - 📶: Connected by Wi-Fi.
 - NET: Lights when connected to the network with the "NET" input selector. It will blink if incorrectly connected to the network.
 - USB: Lights when the "NET" input selector is selected, a USB device is connected and the USB input is selected. It will blink if the USB device is not properly connected.
 - HDMI: HDMI signals are input and the HDMI input is selected.
 - DIGITAL: Digital signals are input and the digital input is selected.
3. Lights according to the type of input digital audio signal and the listening mode.
4. Lights in the following conditions.
 - RDS (European, Australian and Asian models): Receiving RDS broadcasting.
 - TUNED: Receiving AM/FM radio.
 - FM ST: Receiving FM stereo.
 - SLEEP: Sleep timer is set. (→p144)
 - AUTO STBY: Auto Standby is set. (→p144)
5. Blinks when muting is on.
6. Displays various information of the input signals.
 - "DialogNorm: X dB" ("X" is a numerical value) may be displayed when a Dolby Digital, Dolby Digital Plus or Dolby TrueHD source is played. For example, if "DialogNorm: +4 dB" is displayed, the source being played is recorded with 4 dB plus the THX standard level. If you play it with the THX standard level, lower the volume by 4 dB.
7. This may light when operating with the "NET" input selector.

Rear Panel

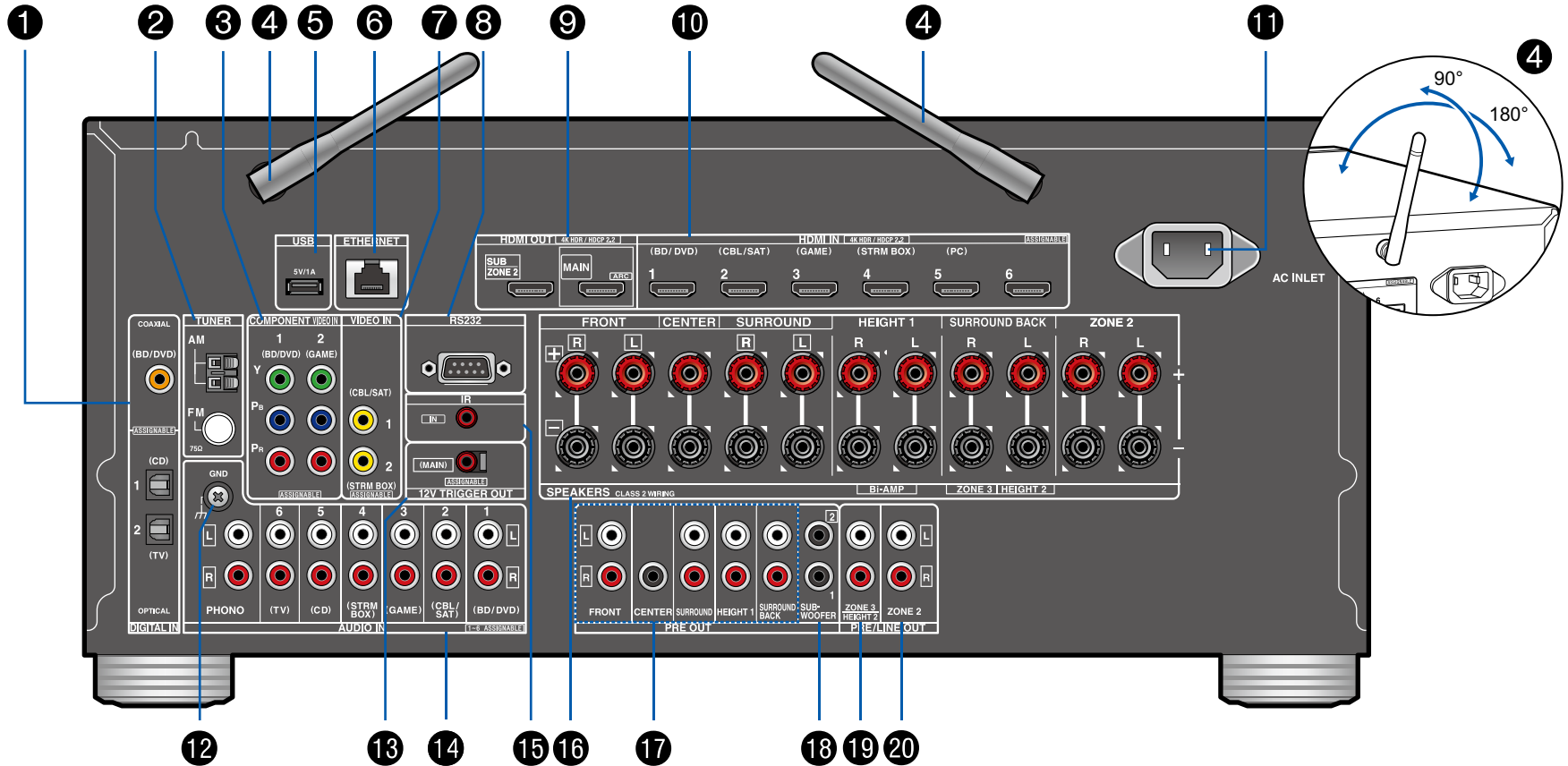

□ For details, see (→p10)

1. DIGITAL IN OPTICAL/COAXIAL jacks: Input TV or AV component digital audio signals with a digital optical cable or digital coaxial cable.
2. TUNER AM/FM terminal: Connect the supplied antennas.
3. COMPONENT VIDEO IN jacks: Input AV component video signals with a component video cable. (Compatible only with 480i or 576i resolution.)
4. Wireless antenna: Used for Wi-Fi connection or when using a BLUETOOTH-enabled device. Adjust the angles according to the connection status.
5. USB port: Connect a USB storage device to play music files. (→[p83](#)) You can also supply power (5 V/1 A) to USB devices with a USB cable.
6. ETHERNET port: Connect to the network with a LAN cable.
7. VIDEO IN jacks: Input AV component video signals with an analog video cable.
8. RS-232C port: Connect a home control system equipped with an RS-232C port. For adopting a home control system, contact the specialized stores.
9. HDMI OUT jacks: Transmit video signals and audio signals with an HDMI cable connected to a monitor such as a TV or projector.
10. HDMI IN jacks: Transmit video signals and audio signals with an HDMI cable connected to an AV component.
11. AC INLET: Connect the supplied power cord.
12. GND terminal: Connect the ground wire of the turntable.
13. 12V TRIGGER OUT jack: Connect a device equipped with a 12V trigger input jack to enable power link operation between the device and this unit. (→[p72](#))
14. AUDIO IN jacks: Input TV or AV component audio signals with an analog audio cable.
15. IR IN port: Connect a remote control receiver unit.(→[p71](#))
16. SPEAKERS terminals: Connect speakers with speaker cables. (North American models support banana plugs.)
17. PRE OUT jacks: Connect a power amplifier. (→[p57](#))
18. SUBWOOFER PRE OUT jacks: Connect a powered subwoofer with a subwoofer cable. Up to two powered subwoofers can be connected. The same signal is output from each SUBWOOFER PRE OUT jack.
19. ZONE 3 PRE/LINE OUT jacks: Output audio signals with an analog audio cable connected to a pre-main amplifier or a power amplifier in a separate room (ZONE 3).
HEIGHT 2 PRE OUT jacks: Connect a power amplifier. (→[p57](#))
20. ZONE 2 PRE/LINE OUT jacks: Output audio signals with an analog audio cable connected to a pre-main amplifier or a power amplifier in a separate room (ZONE 2).

Remote Controller

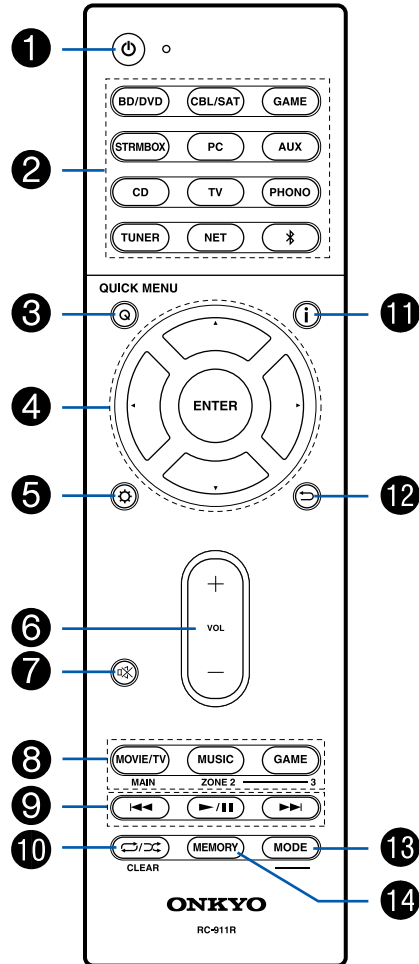

1. **ON/STANDBY button**
2. **Input selector buttons:** Switches the input to be played.
3. **Q (QUICK MENU) button:** Pressing this button during playback can make settings such as "Tone" and "Level" quickly on the TV screen while playing. (→p148)
4. **Cursor buttons and ENTER button:** Select an item with the cursors, and press ENTER to confirm your selection. Pressing ◀/▶ can switch the screen when a music folder list or file list is not displayed on one screen on the TV.
5. **ⓘ button:** Display advanced setting items on the TV or the display to have a more enjoyable experience with this unit. (→p125)
6. **VOLUME buttons**
7. **⊘ button:** Temporarily mutes audio. Press the button again to cancel muting.
8. **LISTENING MODE button:** Select a listening mode (→p105).
MAIN/ZONE 2/ZONE 3 button: Control the multi-zone function (→p98).
9. **Play buttons:** Used for playback operations for the Music Server (→p86) or USB device (→p83).
10. **↺/↻ button:** Used for repeat/random playback operations for the Music Server (→p86) or USB device (→p83). Each time you press the button, the mode switches in the order of 1 (1-track repeat), 2 (folder repeat), and 3 (random).
CLEAR button: Deletes all characters you have entered when entering text on the TV screen.
11. **ⓘ button:** Switches the information on the display and is used to operate RDS (→p97).
12. **↵ button:** Returns the display to the previous state while setting.
13. **MODE button:** Used to switch between automatic tuning and manual tuning for AM/FM stations (→p93), or operate the multi-zone function (→p98).
14. **MEMORY button:** Used to register AM/FM radio stations. (→p95)

Tips

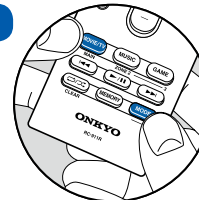

If the remote controller does not work: The remote controller may have switched to the ZONE control mode. While pressing and holding MODE, press the MAIN button for 3 seconds or more until the remote indicator blinks once, and then switch it to the main room control mode.

Connections

Connecting speakers	13
Connecting the TV	59
Connecting Playback Devices	62
Connecting an AV Component in a Separate Room (Multi-zone Connection)	66
Connecting Antennas	69
Network Connection	70
Connecting External Control Devices	71
Connecting the Power Cord	73

Connecting speakers

You can select the layout of speakers to be installed from various patterns when using this unit. Use the following flow chart to select the speaker layout that suits your speakers and usage environment. You can check the connection method and default settings. Dolby Atmos (→p107) listening mode faithfully reproduces the sound design recorded in the Dolby Atmos audio format by installing Surround Back Speakers or Height Speakers. Dolby Atmos enables the accurate placement of sound objects that have independent motion in a three-dimensional space with even greater clarity.

Do you enjoy sound with Dolby Atmos?

Yes

■ When using Surround Back Speakers

- 7.1 Channel System (→p45)
- 7.1 Channel System + ZONE SPEAKER (→p46)
- 7.1 Channel System (Bi-Amping the Speakers) (→p47)

■ When using 1 set of Height Speakers

- 5.1.2 Channel System (→p48)
- 5.1.2 Channel System + ZONE SPEAKER (→p49)
- 5.1.2 Channel System (Bi-Amping the Speakers) (→p50)
- 7.1.2 Channel System (→p51)
- 7.1.2 Channel System + ZONE SPEAKER (→p52)

■ When using 2 sets of Height Speakers

- 5.1.4 Channel System (→p53)
- 5.1.4 Channel System + ZONE SPEAKER (→p54)
- 7.1.4 Channel System (→p55)
- 7.1.4 Channel System + ZONE SPEAKER (→p56)

No

- 5.1 Channel System (→p42)
- 5.1 Channel System + ZONE SPEAKER (→p43)
- 5.1 Channel System (Bi-Amping the Speakers) (→p44)

Speaker Installation

■ 5.1 Channel System

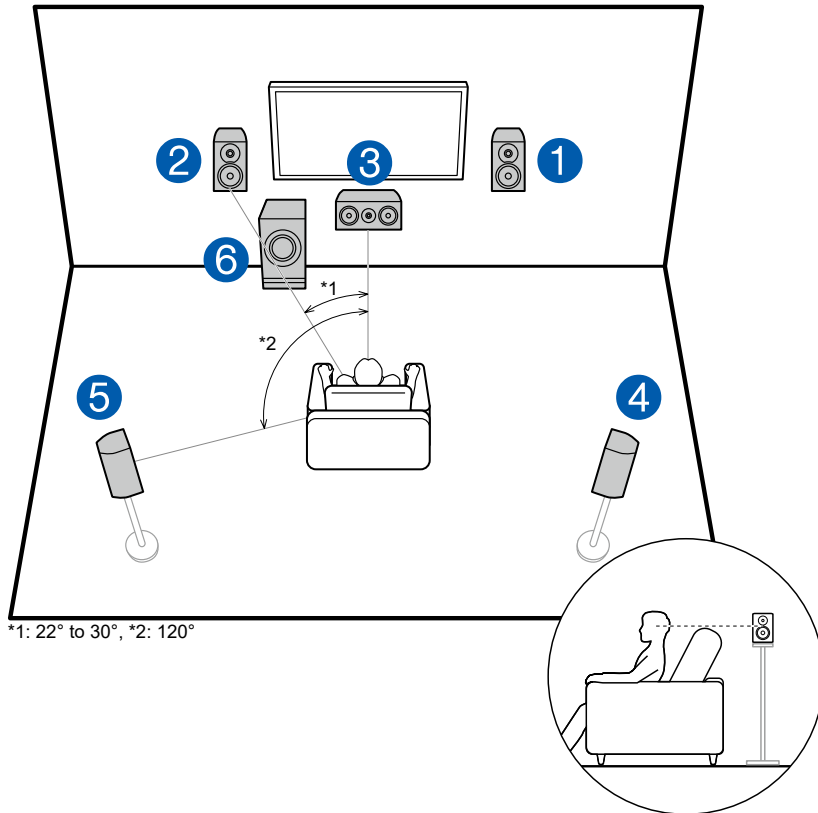

*1: 22° to 30°, *2: 120°

This is a basic 5.1 Channel System. Front speakers output the front stereo sound, and a center speaker outputs the sound of the center of the screen, such as dialogs and vocals. Surround speakers create the back sound field. Powered subwoofer reproduces the bass sound, and creates the rich sound field. The front speakers should be positioned at ear height while the surround speakers should be positioned just above ear height. The center speaker should be set up facing the listening position at an angle. Placing the powered subwoofer between the center speaker and the front speaker gives you a natural sound even when playing music sources.

- 1,2 Front Speakers
- 3 Center Speaker
- 4,5 Surround Speakers
- 6 Powered Subwoofer

■ 7.1 Channel System

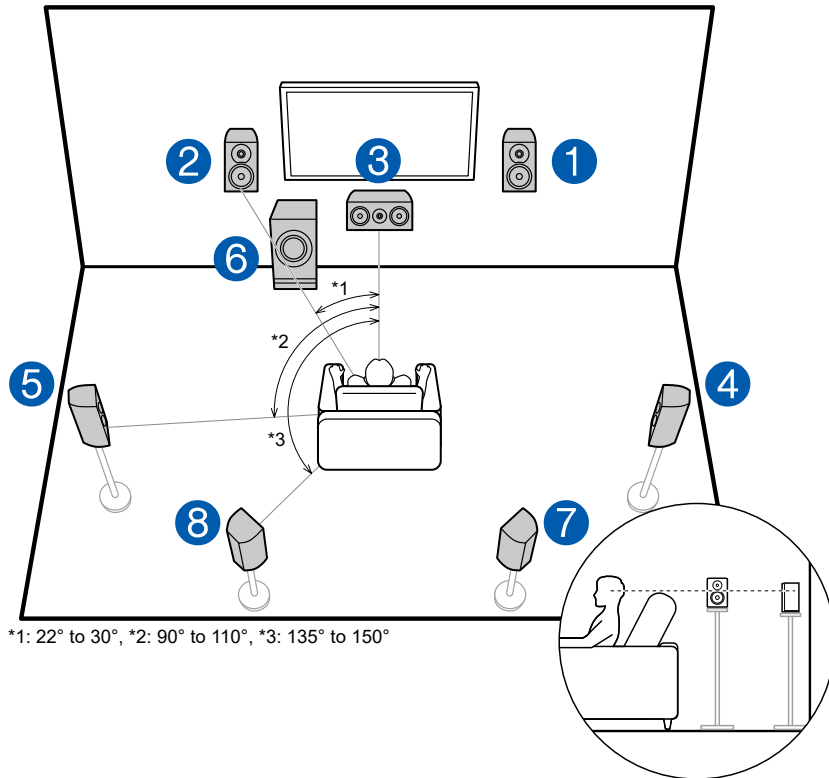

This is a 7.1 Channel System that consists of the basic 5.1 Channel System (→p14) and added surround back speakers. Front speakers output the front stereo sound, and a center speaker outputs the sound of the center of the screen, such as dialogs and vocals. Surround speakers create the back sound field. Powered subwoofer reproduces the bass sound, and creates the rich sound field. Surround back speakers improves the sense of envelopment and connectivity of sound in the back sound field, and provides a more real sound field. Furthermore, by installing surround back speakers, when the input format is Dolby Atmos, you can select the Dolby Atmos listening mode which realizes the most up-to-date 3D sound,

The front speakers should be positioned at ear height while the surround speakers should be positioned just above ear height. The center speaker should be set up facing the listening position at an angle. Placing the powered subwoofer between the center speaker and the front speaker gives you a natural sound even when playing music sources. The surround back speakers should be positioned at ear height.

- If surround back speakers are installed, be sure to install surround speakers as well.

- 1,2 Front Speakers
- 3 Center Speaker
- 4,5 Surround Speakers
- 6 Powered Subwoofer
- 7,8 Surround Back Speakers

■ 5.1.2 Channel System

A 5.1.2 Channel System is a speaker layout consisting of the basic 5.1 Channel System ([→p14](#)) and added height speakers. Select the height speakers that suit your speakers and usage environment from the following three types.

- Front High Speakers/Rear High Speakers
Installation Example ([→p17](#))**
- Ceiling Speakers Installation Example
([→p18](#))**
- Dolby Enabled Speakers (Dolby Speakers)
Installation Example ([→p19](#))**

□ Front High Speakers/Rear High Speakers Installation Example

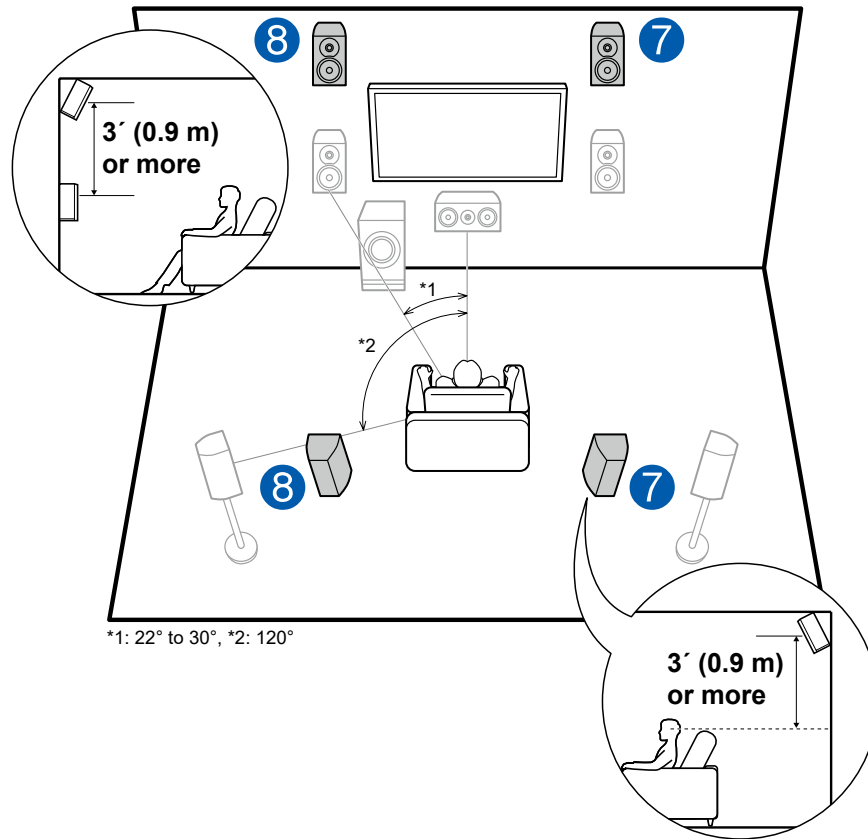

This is a system with the basic 5.1 channel system (→p14) consisting of front speakers, a center speaker, surround speakers and a powered subwoofer, and added front high speakers or rear high speakers combined. By installing such height speakers, when the input format is Dolby Atmos, you can select the Dolby Atmos listening mode which realizes the most up-to-date 3D sound including overhead sound. Front high speakers or rear high speakers should be installed at least 3' / 0.9 m higher than the front speakers.

Front high speakers should be installed directly above the front speakers, and the distance between the rear high speakers should match the distance between the front speakers. In both cases, the speakers should be set up facing the listening position at an angle.

7,8 Height Speakers

Choose one of the following:

- Front High Speakers
- Rear High Speakers

□ Ceiling Speakers Installation Example

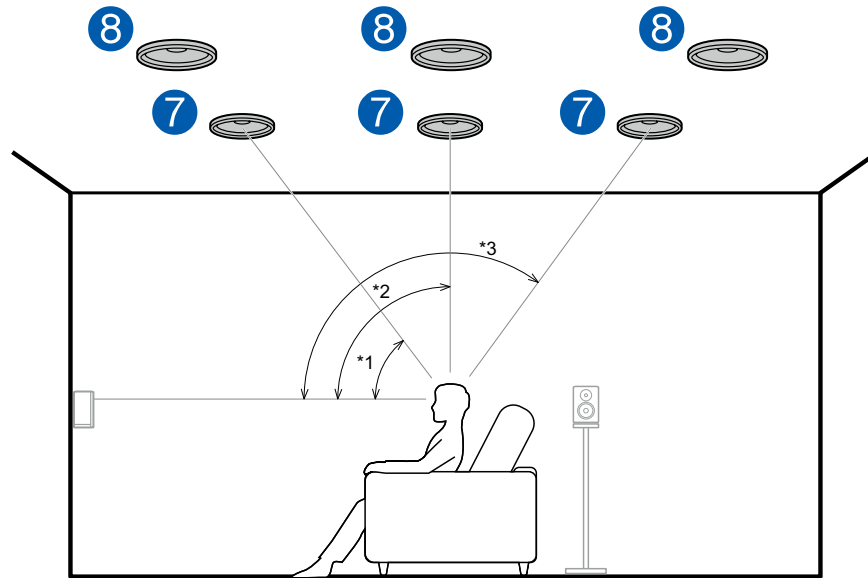

*1: 30° to 55°, *2: 65° to 100°, *3: 125° to 150°

This is a system with the basic 5.1 channel system (→p14) consisting of front speakers, a center speaker, surround speakers and a powered subwoofer, and added top front speakers or top middle speakers or top rear speakers combined. By installing such height speakers, when the input format is Dolby Atmos, you can select the Dolby Atmos listening mode which realizes the most up-to-date 3D sound including overhead sound. Install the top front speakers on the ceiling anterior to the seating position, top middle speakers on the ceiling directly above the seating position, and top rear speakers on the ceiling posterior to the seating position. The distance between each pair should match the distance between the front speakers.

- Dolby Laboratories recommends the setups of these types of height speakers to obtain the best Dolby Atmos effect.

7,8 Height Speakers

Choose one of the following:

- Top Front Speakers
- Top Middle Speakers
- Top Rear Speakers

❑ Dolby Enabled Speakers (Dolby Speakers) Installation Example

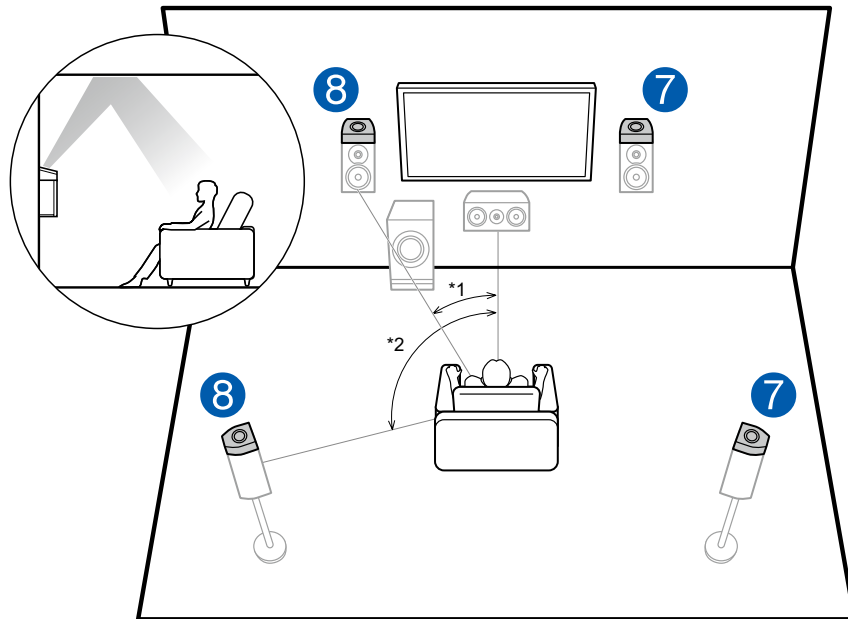

*1: 22° to 30°, *2: 120°

This is a system with the basic 5.1 channel system (→p14) consisting of front speakers, a center speaker, surround speakers and a powered subwoofer, and added Dolby enabled speakers (front) or Dolby enabled speakers (surround) combined. Dolby enabled speakers are special speakers designed to face the ceiling, so that the sound is heard from overhead by bouncing the sound off the ceiling. By installing such height speakers, when the input format is Dolby Atmos, you can select the Dolby Atmos listening mode which realizes the most up-to-date 3D sound including overhead sound. Install them either on the front speakers or on the surround speakers.

7,8 Height Speakers

Choose one of the following:

- Dolby Enabled Speakers (Front)
- Dolby Enabled Speakers (Surround)

■ 7.1.2 Channel System

A 7.1.2 Channel System is a speaker layout consisting of the 7.1 Channel System (→[p15](#)) and added height speakers. Select the height speakers that suit your speakers and usage environment from the following three types.

- Front High Speakers/Rear High Speakers
Installation Example (→[p21](#))**
- Ceiling Speakers Installation Example
(→[p22](#))**
- Dolby Enabled Speakers (Dolby Speakers)
Installation Example (→[p23](#))**

❑ Front High Speakers/Rear High Speakers Installation Example

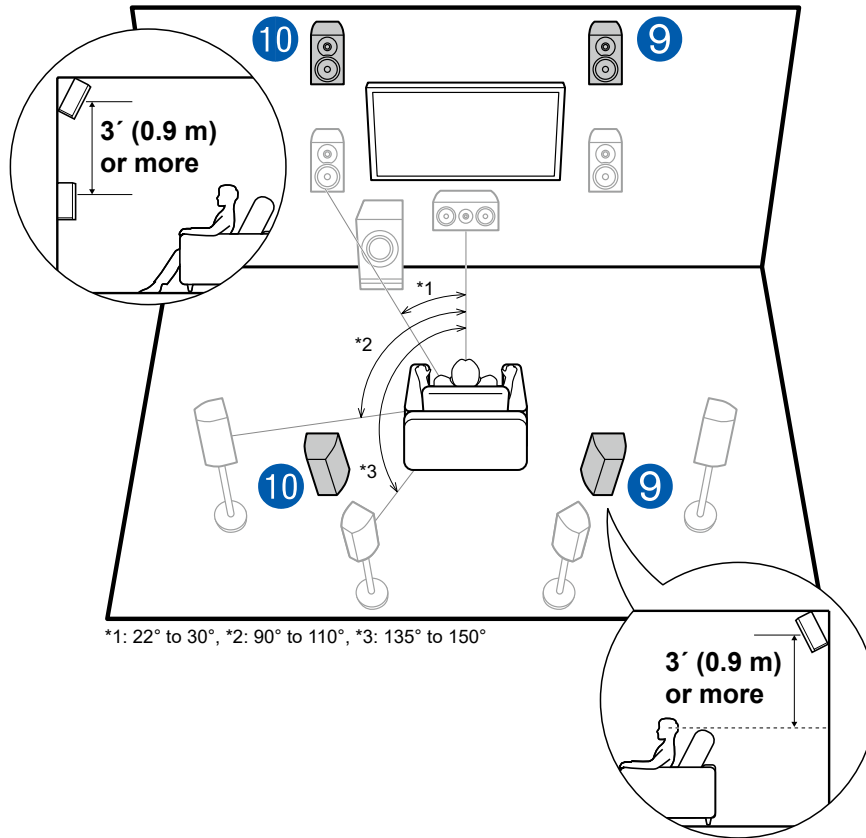

This is a system with the 7.1 channel system (→p15) consisting of front speakers, a center speaker, surround speakers, surround back speakers and a powered subwoofer, and added front high speakers or rear high speakers combined. By installing such height speakers, when the input format is Dolby Atmos, you can select the Dolby Atmos listening mode which realizes the most up-to-date 3D sound including overhead sound. Front high speakers or rear high speakers should be installed at least 3'/0.9 m higher than the front speakers. Front high speakers should be installed directly above the front speakers, and the distance between the rear high speakers should match the distance between the front speakers. In both cases, the speakers should be set up facing the listening position at an angle.

9,10 Height Speakers

Choose one of the following:

- Front High Speakers
- Rear High Speakers

□ Ceiling Speakers Installation Example

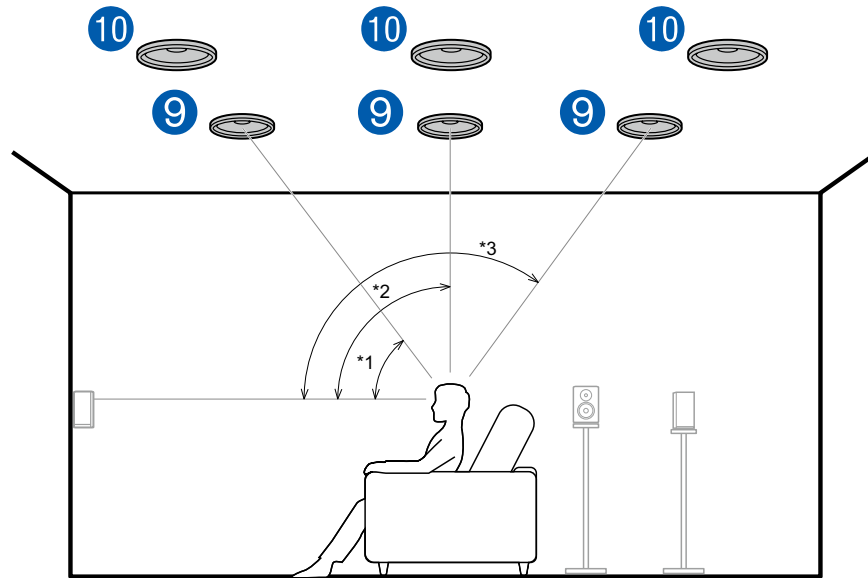

*1: 30° to 55°, *2: 65° to 100°, *3: 125° to 150°

This is a system with the 7.1 channel system (→p15) consisting of front speakers, a center speaker, surround speakers, surround back speakers and a powered subwoofer, and added top front speakers or top middle speakers or top rear speakers combined. By installing such height speakers, when the input format is Dolby Atmos, you can select the Dolby Atmos listening mode which realizes the most up-to-date 3D sound including overhead sound. Install the top front speakers on the ceiling anterior to the seating position, top middle speakers on the ceiling directly above the seating position, and top rear speakers on the ceiling posterior to the seating position. The distance between each pair should match the distance between the front speakers.

- Dolby Laboratories recommends the setups of these types of height speakers to obtain the best Dolby Atmos effect.

9,10 Height Speakers

Choose one of the following:

- Top Front Speakers
- Top Middle Speakers
- Top Rear Speakers

❑ Dolby Enabled Speakers (Dolby Speakers) Installation Example

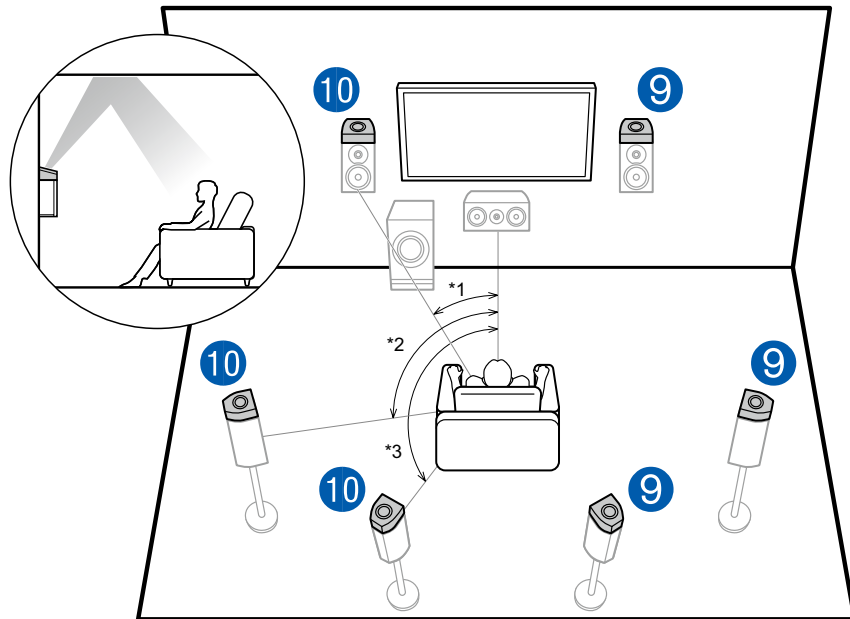

*1: 22° to 30°, *2: 90° to 110°, *3: 135° to 150°

This is a system with the 7.1 channel system (→p15) consisting of front speakers, a center speaker, surround speakers, surround back speakers and a powered subwoofer, and added Dolby enabled speakers (front), Dolby enabled speakers (surround) or Dolby enabled speakers (surround back) combined. Dolby enabled speakers are special speakers designed to face the ceiling, so that the sound is heard from overhead by bouncing the sound off the ceiling. By installing such height speakers, when the input format is Dolby Atmos, you can select the Dolby Atmos listening mode which realizes the most up-to-date 3D sound including overhead sound. Install them either on the front speakers, on the surround speakers or on the surround back speakers.

9,10 Height Speakers

Choose one of the following:

- Dolby Enabled Speakers (Front)
- Dolby Enabled Speakers (Surround)
- Dolby Enabled Speakers (Surround Back)

■ 5.1.4 Channel System

A 5.1.4 Channel System is a speaker layout combining 2 sets of the height speakers, 1 set of left and right at the front and 1 set of left and right at the rear, to the basic 5.1 Channel System (→[p14](#)). By installing the height speakers, when the input format is Dolby Atmos, you can select the Dolby Atmos listening mode which realizes the most up-to-date 3D sound including overhead sound. Combination of 2 height speakers can be selected from following.

- ❑ **Combination example when Top Front Speakers are used at the front (→[p25](#))**
- ❑ **Combination example when Top Middle Speakers are used at the front (→[p27](#))**
- ❑ **Combination example when Front High Speakers are used at the front (→[p28](#))**
- ❑ **Combination example when Dolby Enabled Speakers (Front) are used at the front (→[p30](#))**

❑ Combination example when Top Front Speakers are used at the front

About the top front speakers

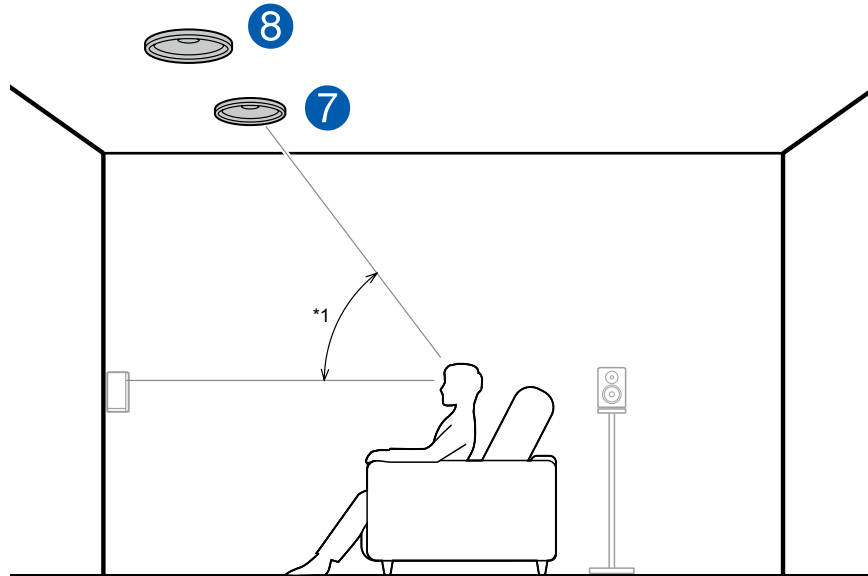

*1: 30° to 55°

The top front speakers are installed on the ceiling at front of the listening position, and the width between the left and right speakers is optimal to match the one for the front speakers. When the top front speakers are used in front, the combination of the height speakers at the rear can be selected from the following 3 examples shown at the right.

7,8 Top Front Speakers

(Example 1) Use top rear speakers at the rear

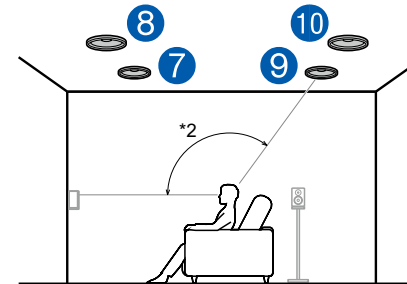

*2: 125° to 150°

The top rear speakers are installed on the ceiling at rear of the listening position, and the width between the left and right speakers is optimal to match the one for the front speakers.

9,10 Top Rear Speakers

(Example 2) Use rear high speakers at the rear

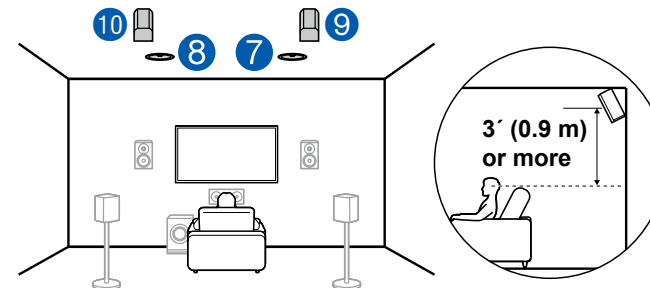

The width between the rear high speakers should match the one for the front speakers, and they should be installed minimum of 3'/0.9 m higher than the front speakers, and tilted so they will point toward the listener.

9,10 Rear High Speakers

(Example 3) Use Dolby Enabled Speakers (Surround) at the rear

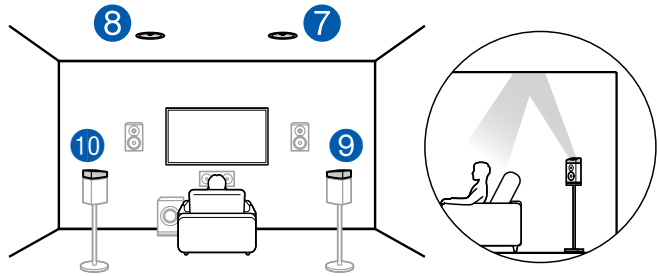

The Dolby enabled speakers are the special speaker that the sound is emitted toward the ceiling, and have the effect the sound to come from above by reflecting the sound on the ceiling.

The Dolby enabled speakers (surround) are installed on top of the surround speakers.

9,10 Dolby Enabled Speakers (Surround)

❑ Combination example when Top Middle Speakers are used at the front

About the top middle speakers

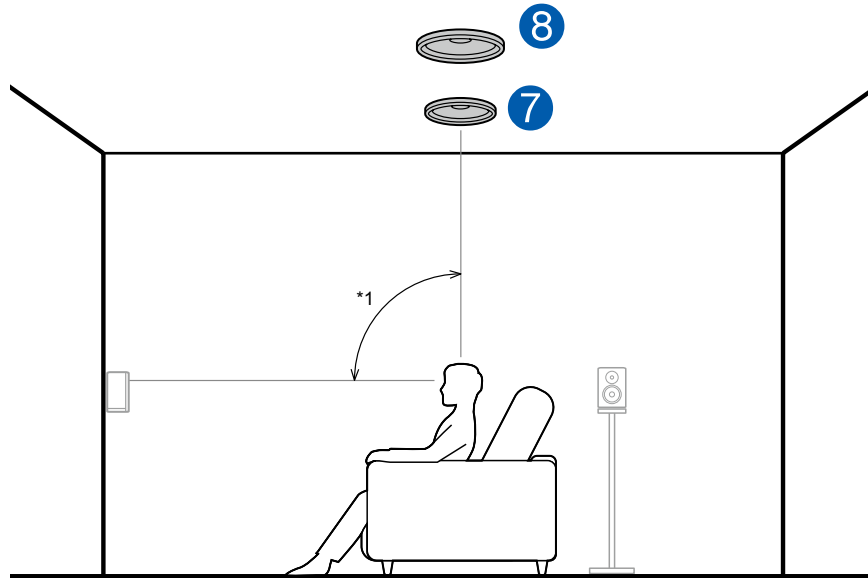

*1: 65° to 100°

The top middle speakers are installed on the ceiling immediately above the listening position, and the width between the left and right speakers is optimal to match the one for the front speakers. When the top middle speakers are used in front, the rear high speakers in the figure at the right can be used at the rear.

7,8 Top Middle Speakers

Use rear high speakers at the rear

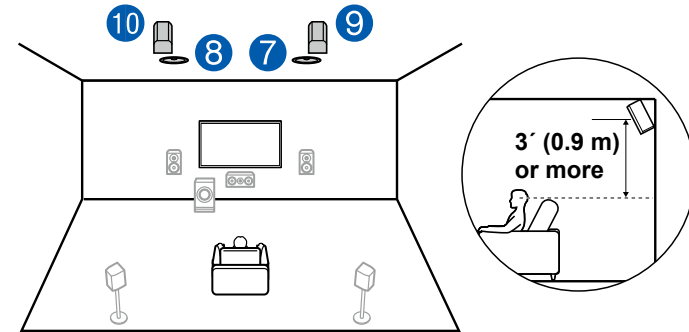

The width between the rear high speakers should match the one for the front speakers, and they should be installed minimum of 3'/0.9 m higher than the front speakers, and tilted so they will point toward the listener.

9,10 Rear High Speakers

❑ **Combination example when Front High Speakers are used at the front**

About the front high speakers

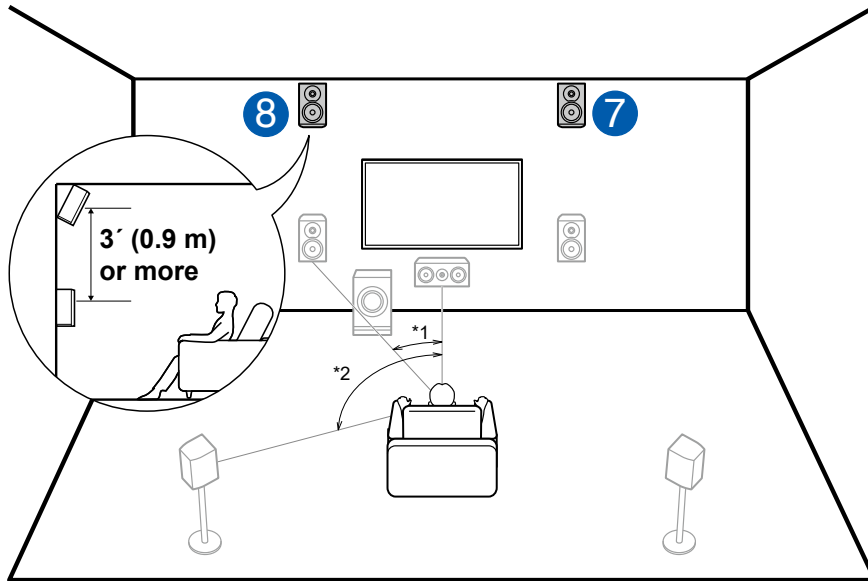

*1: 22° to 30°, *2: 120°

Install the front high speakers immediately above the front speakers minimum of 3'/0.9 m higher, and tilted so they will point toward the listener. When the front high speakers are used in front, the combination of the height speakers at the rear can be selected from the following 4 examples shown at the right.

7,8 Front High Speakers

(Example 1) Use rear high speakers at the rear

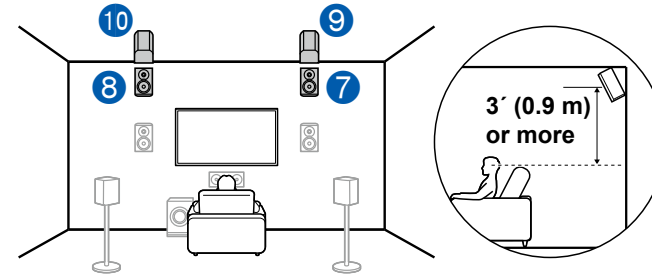

The width between the rear high speakers should match the one for the front speakers, and they should be installed minimum of 3'/0.9 m higher than the front speakers, and tilted so they will point toward the listener.

9,10 Rear High Speakers

(Example 2) Use top middle speakers at the rear

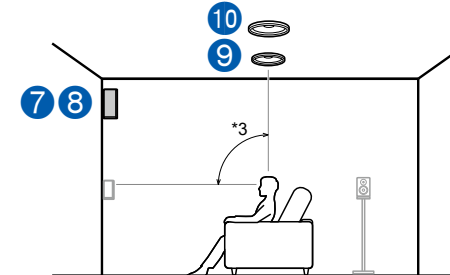

*3: 65° to 100°

The top middle speakers are installed on the ceiling immediately above the listening position, and the width between the left and right speakers is optimal to match the one for the front speakers.

9,10 Top Middle Speakers

(Example 3) Use top rear speakers at the rear

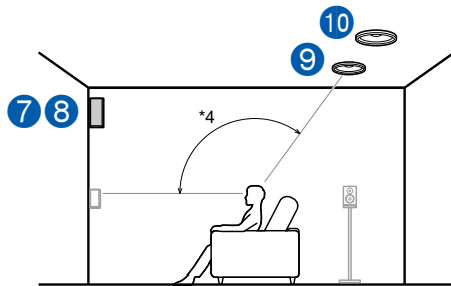

*4: 125° to 150°

The top rear speakers are installed on the ceiling at rear of the listening position, and the width between the left and right speakers is optimal to match the one for the front speakers.

9,10 Top Rear Speakers

(Example 4) Use Dolby Enabled Speakers (Surround) at the rear

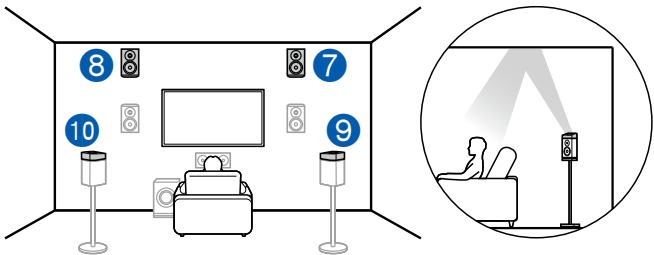

The Dolby enabled speakers are the special speaker that the sound is emitted toward the ceiling, and have the effect the sound to come from above by reflecting the sound on the ceiling.

The Dolby enabled speakers (surround) are installed on top of the surround speakers.

9,10 Dolby Enabled Speakers (Surround)

❑ Combination example when Dolby Enabled Speakers (Front) are used at the front

About the Dolby enabled speakers (front)

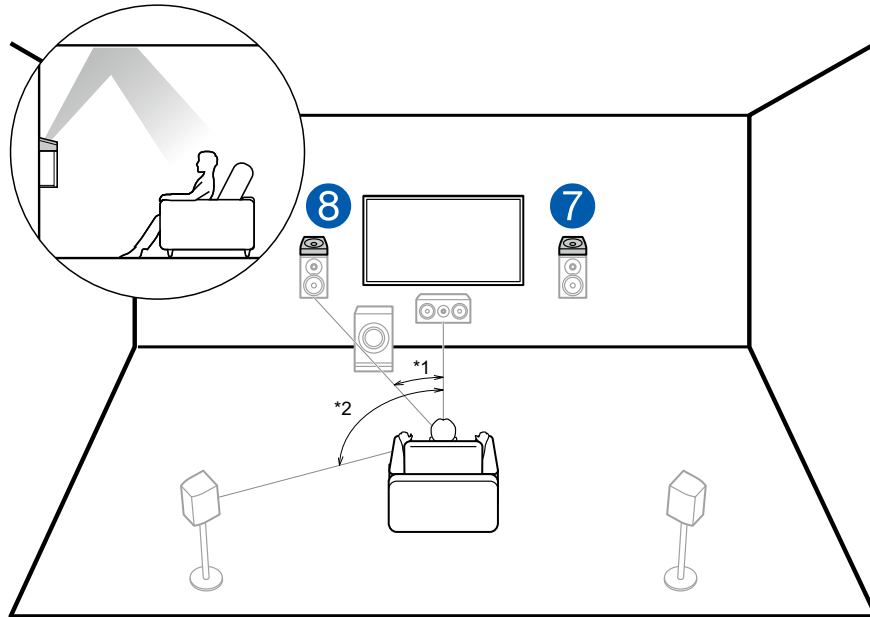

*1: 22° to 30°, *2: 120°

The Dolby enabled speakers are the special speaker that the sound is emitted toward the ceiling, and have the effect the sound to come from above by reflecting the sound on the ceiling.

The Dolby enabled speakers (front) are installed on top of the front speakers. When the Dolby enabled speakers (front) are used in front, the combination of the height speakers at the rear can be selected from the following 3 examples shown at the right.

7,8 Dolby Enabled Speakers (Front)

(Example 1) Use top rear speakers at the rear

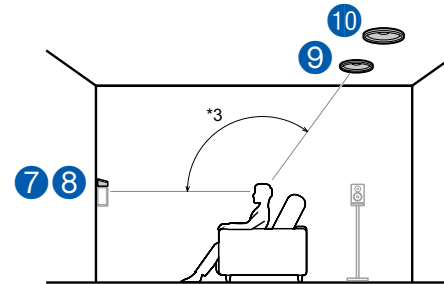

*3: 125° to 150°

The top rear speakers are installed on the ceiling at rear of the listening position, and the width between the left and right speakers is optimal to match the one for the front speakers.

9,10 Top Rear Speakers

(Example 2) Use rear high speakers at the rear

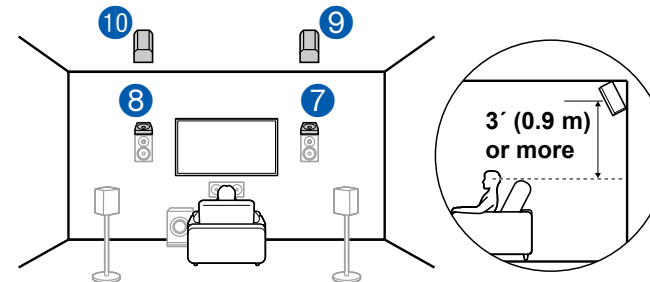

The width between the rear high speakers should match the one for the front speakers, and they should be installed minimum of 3' / 0.9 m higher than the front speakers, and tilted so they will point toward the listener.

9,10 Rear High Speakers

(Example 3) Use Dolby Enabled Speakers (Surround) at the rear

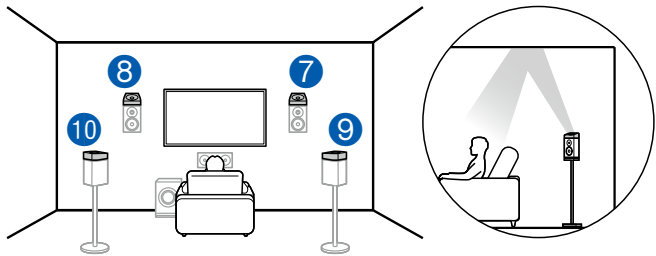

The Dolby enabled speakers are the special speaker that the sound is emitted toward the ceiling, and have the effect the sound to come from above by reflecting the sound on the ceiling.

The Dolby enabled speakers (surround) are installed on top of the surround speakers.

9,10 Dolby Enabled Speakers (Surround)

■ 7.1.4 Channel System

A 7.1.4 Channel System is a speaker layout combining 2 sets of the height speakers, 1 set of left and right at the front and 1 set of left and right at the rear, to the basic 7.1 Channel System (→[p15](#)). By installing the height speakers, when the input format is Dolby Atmos, you can select the Dolby Atmos listening mode which realizes the most up-to-date 3D sound including overhead sound. Combination of 2 height speakers can be selected from following.

- ❑ **Combination example when Top Front Speakers are used at the front (→[p33](#))**
- ❑ **Combination example when Top Middle Speakers are used at the front (→[p35](#))**
- ❑ **Combination example when Front High Speakers are used at the front (→[p36](#))**
- ❑ **Combination example when Dolby Enabled Speakers (Front) are used at the front (→[p38](#))**

❑ Combination example when Top Front Speakers are used at the front

About the top front speakers

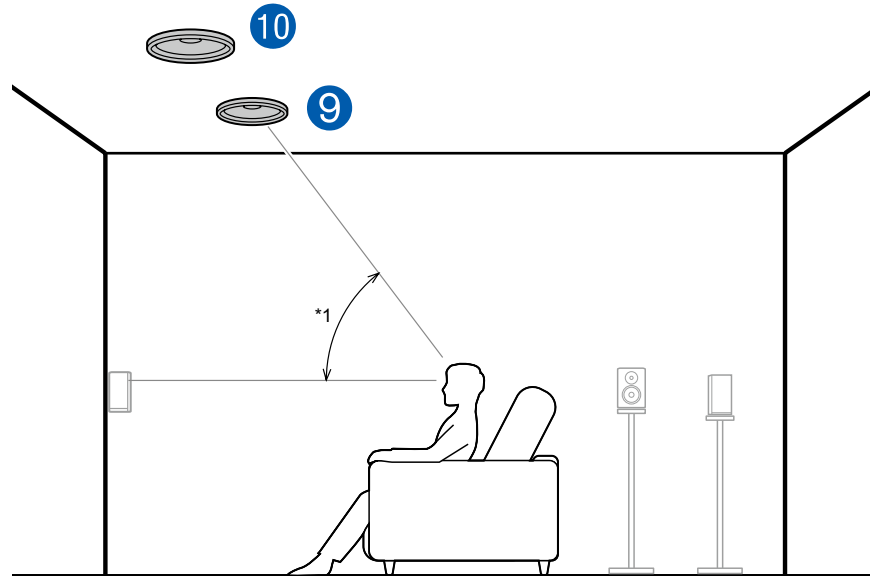

*1: 30° to 55°

The top front speakers are installed on the ceiling at front of the listening position, and the width between the left and right speakers is optimal to match the one for the front speakers. When the top front speakers are used in front, the combination of the height speakers at the rear can be selected from the following 4 examples shown at the right.

9,10 Top Front Speakers

(Example 1) Use top rear speakers at the rear

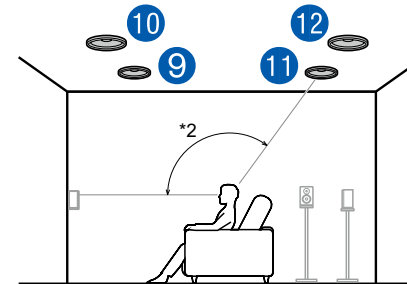

*2: 125° to 150°

The top rear speakers are installed on the ceiling at rear of the listening position, and the width between the left and right speakers is optimal to match the one for the front speakers.

11,12 Top Rear Speakers

(Example 2) Use rear high speakers at the rear

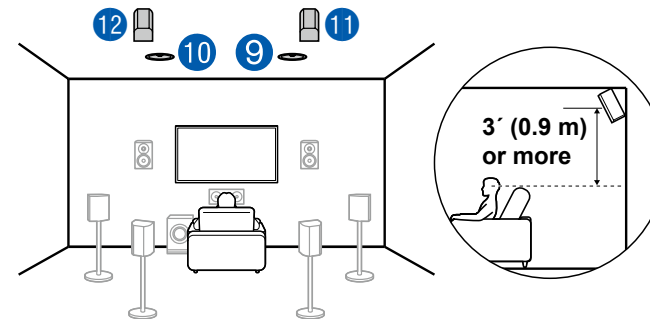

The width between the rear high speakers should match the one for the front speakers, and they should be installed minimum of 3'/0.9 m higher than the front speakers, and tilted so they will point toward the listener.

11,12 Rear High Speakers

(Example 3) Use Dolby Enabled Speakers (Surround) at the rear

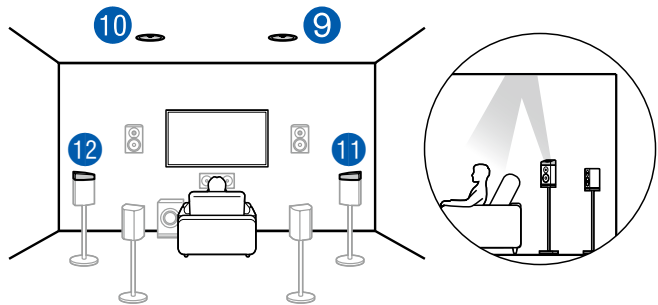

The Dolby enabled speakers are the special speaker that the sound is emitted toward the ceiling, and have the effect the sound to come from above by reflecting the sound on the ceiling.

The Dolby enabled speakers (surround) are installed on top of the surround speakers.

11,12 Dolby Enabled Speakers (Surround)

(Example 4) Use Dolby Enabled Speakers (Surround Back) at the rear

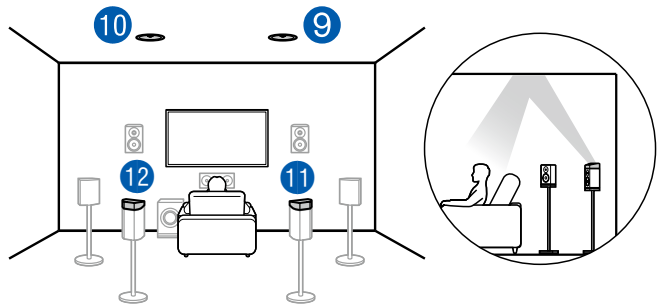

The Dolby enabled speakers are the special speaker that the sound is emitted toward the ceiling, and have the effect the sound to come from above by reflecting the sound on the ceiling.

The Dolby enabled speakers (surround back) are installed on top of the surround back speakers.

11,12 Dolby Enabled Speakers (Surround Back)

❑ Combination example when Top Middle Speakers are used at the front

About the top middle speakers

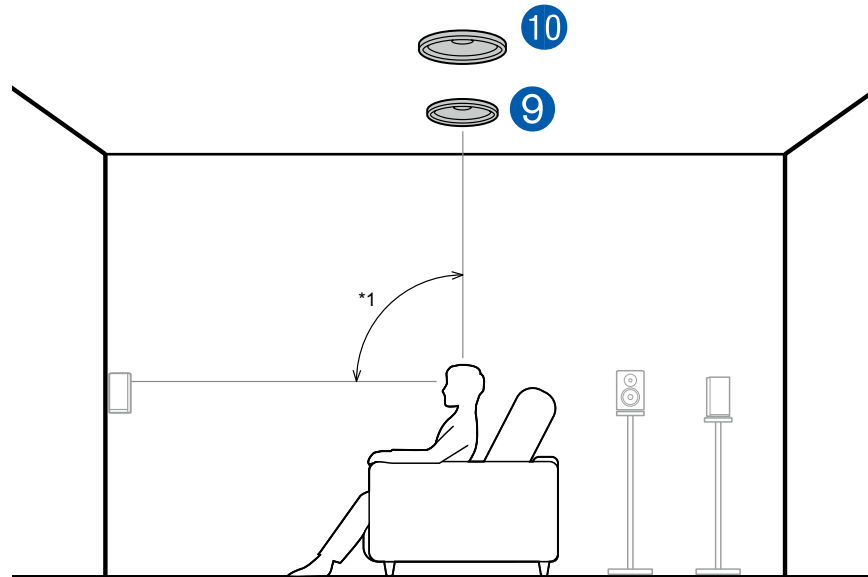

*1: 65° to 100°

The top middle speakers are installed on the ceiling immediately above the listening position, and the width between the left and right speakers is optimal to match the one for the front speakers. When the top middle speakers are used in front, the rear high speakers in the figure at the right can be used at the rear.

9,10 Top Middle Speakers

Use rear high speakers at the rear

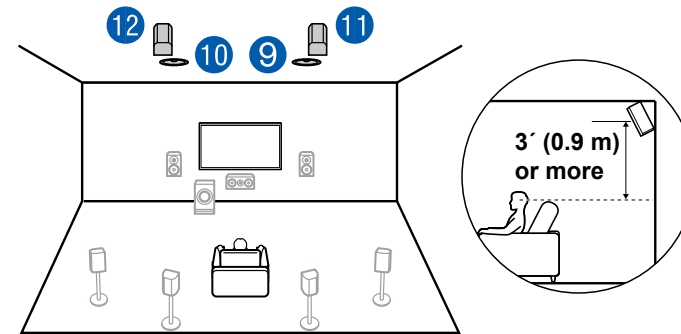

The width between the rear high speakers should match the one for the front speakers, and they should be installed minimum of 3'/0.9 m higher than the front speakers, and tilted so they will point toward the listener.

11,12 Rear High Speakers

❑ Combination example when Front High Speakers are used at the front

About the front high speakers

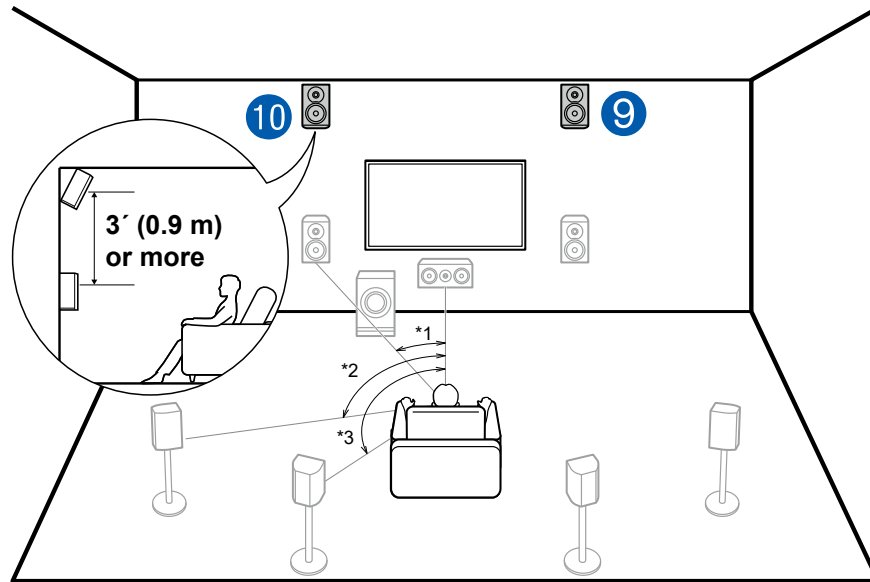

*1: 22° to 30°, *2: 90° to 110°, *3: 135° to 150°

Install the front high speakers immediately above the front speakers minimum of 3'/0.9 m higher, and tilted so they will point toward the listener. When the front high speakers are used in front, the combination of the height speakers at the rear can be selected from the following 5 examples shown at the right.

9,10 Front High Speakers

(Example 1) Use rear high speakers at the rear

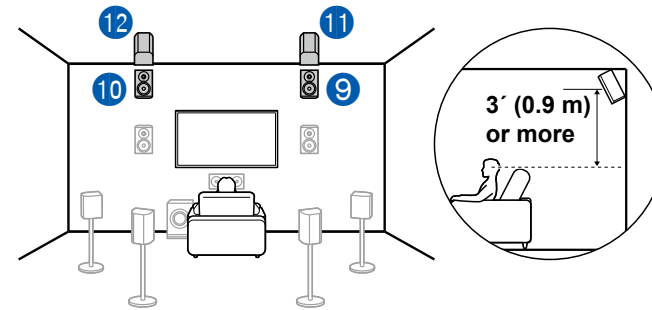

The width between the rear high speakers should match the one for the front speakers, and they should be installed minimum of 3'/0.9 m higher than the front speakers, and tilted so they will point toward the listener.

11,12 Rear High Speakers

(Example 2) Use top middle speakers at the rear

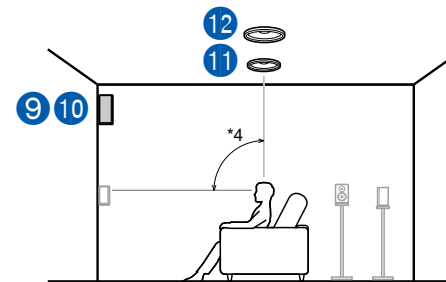

*4: 65° to 100°

The top middle speakers are installed on the ceiling immediately above the listening position, and the width between the left and right speakers is optimal to match the one for the front speakers.

11,12 Top Middle Speakers

(Example 3) Use top rear speakers at the rear

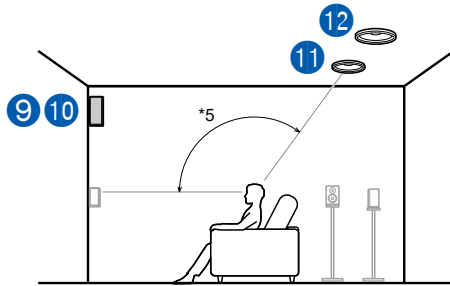

*5: 125° to 150°

The top rear speakers are installed on the ceiling at rear of the listening position, and the width between the left and right speakers is optimal to match the one for the front speakers.

11,12 Top Rear Speakers

(Example 4) Use Dolby Enabled Speakers (Surround) at the rear

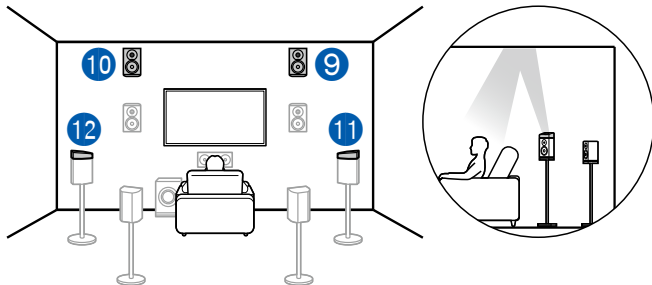

The Dolby enabled speakers are the special speaker that the sound is emitted toward the ceiling, and have the effect the sound to come from above by reflecting the sound on the ceiling.

The Dolby enabled speakers (surround) are installed on top of the surround speakers.

11,12 Dolby Enabled Speakers (Surround)

(Example 5) Use Dolby Enabled Speakers (Surround Back) at the rear

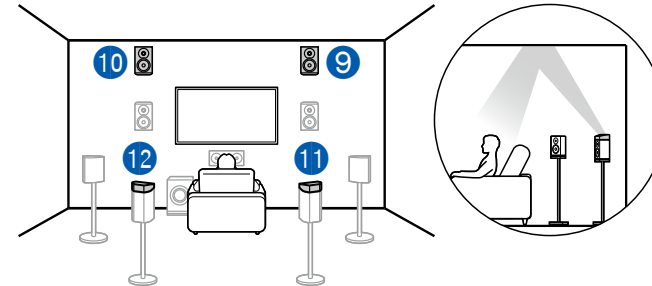

The Dolby enabled speakers are the special speaker that the sound is emitted toward the ceiling, and have the effect the sound to come from above by reflecting the sound on the ceiling.

The Dolby enabled speakers (surround back) are installed on top of the surround back speakers.

11,12 Dolby Enabled Speakers (Surround Back)

❑ Combination example when Dolby Enabled Speakers (Front) are used at the front

About the Dolby enabled speakers (front)

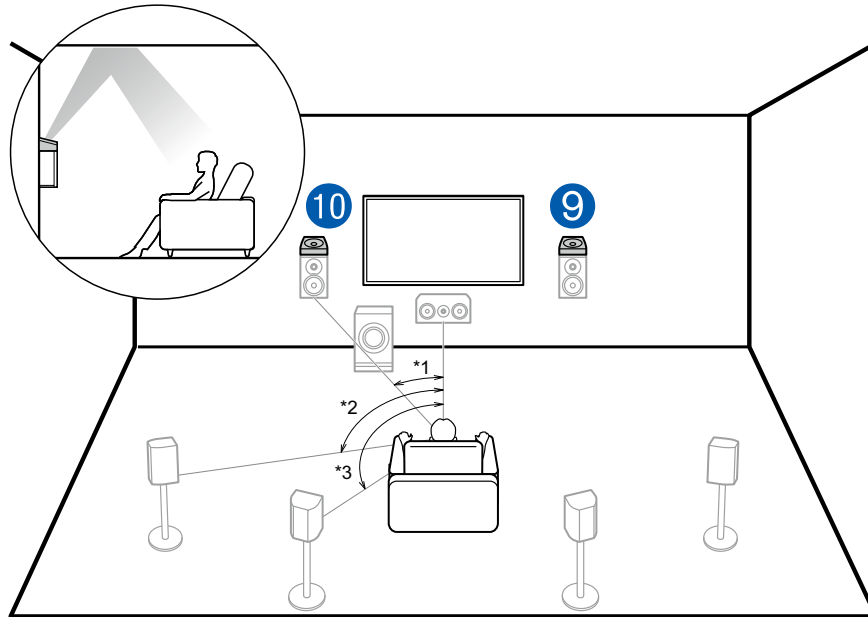

*1: 22° to 30°, *2: 90° to 110°, *3: 135° to 150°

The Dolby enabled speakers are the special speaker that the sound is emitted toward the ceiling, and have the effect the sound to come from above by reflecting the sound on the ceiling.

The Dolby enabled speakers (front) are installed on top of the front speakers. When the Dolby enabled speakers (front) are used in front, the combination of the height speakers at the rear can be selected from the following 4 examples shown at the right.

9,10 Dolby Enabled Speakers (Front)

(Example 1) Use top rear speakers at the rear

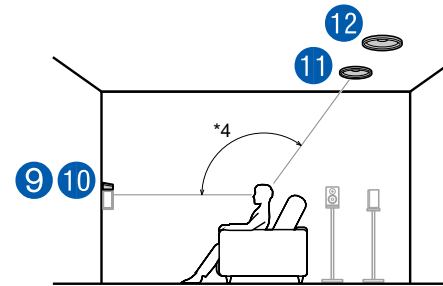

*4: 125° to 150°

The top rear speakers are installed on the ceiling at rear of the listening position, and the width between the left and right speakers is optimal to match the one for the front speakers.

11,12 Top Rear Speakers

(Example 2) Use rear high speakers at the rear

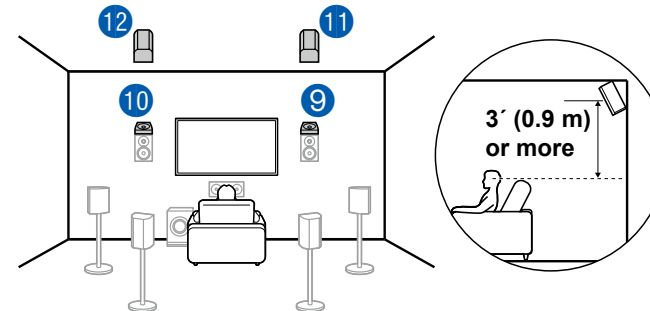

The width between the rear high speakers should match the one for the front speakers, and they should be installed minimum of 3'/0.9 m higher than the front speakers, and tilted so they will point toward the listener.

11,12 Rear High Speakers

(Example 3) Use Dolby Enabled Speakers (Surround) at the rear

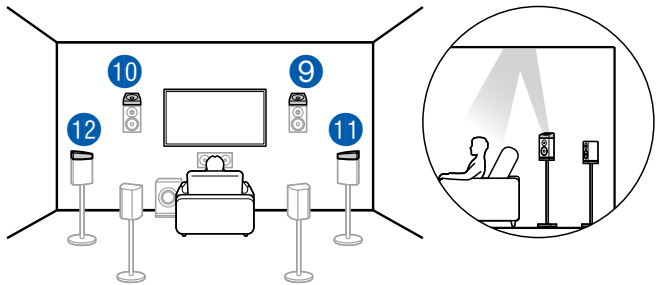

The Dolby enabled speakers are the special speaker that the sound is emitted toward the ceiling, and have the effect the sound to come from above by reflecting the sound on the ceiling.

The Dolby enabled speakers (surround) are installed on top of the surround speakers.

11,12 Dolby Enabled Speakers (Surround)

(Example 4) Use Dolby Enabled Speakers (Surround Back) at the rear

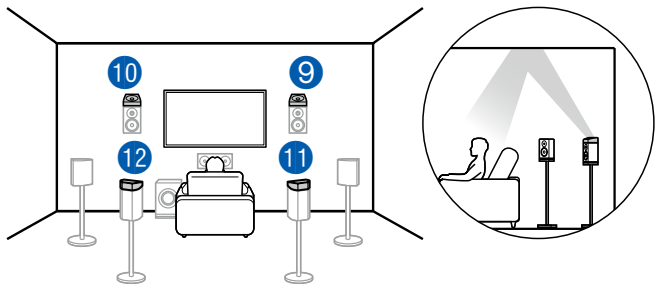

The Dolby enabled speakers are the special speaker that the sound is emitted toward the ceiling, and have the effect the sound to come from above by reflecting the sound on the ceiling.

The Dolby enabled speakers (surround back) are installed on top of the surround back speakers.

11,12 Dolby Enabled Speakers (Surround Back)

Speaker Connections and "Speaker Setup" Settings

Connections

■ (Note) Speaker Impedance

Connect speakers with an impedance of 4 Ω to 16 Ω. If any of the speakers to be connected has an impedance of 4 Ω or more and 6 Ω or less, the setting is required in the Setup menu after the Initial Setup (→p156) is completed. Press  on the remote controller, and set "2. Speaker" - "Configuration" - "Speaker Impedance" to "4ohms".

■ Connect the Speaker Cables

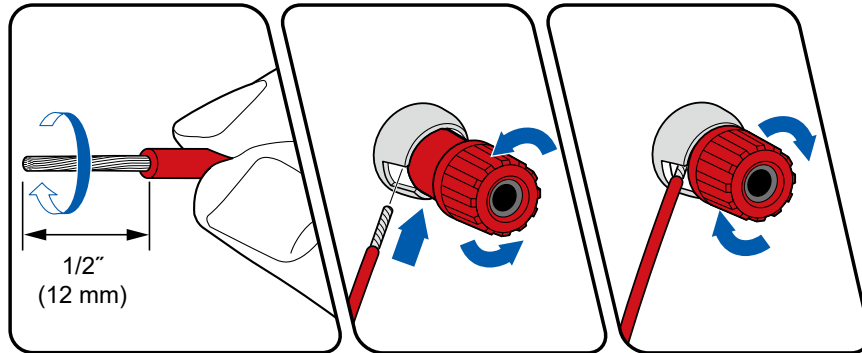

Make correct connection between the unit's jacks and speaker's jacks (+ side to + side, and - side to - side) for each channel. If the connection is wrong, a bass sound will not be reproduced properly due to reverse phase. Twist the wires exposed from the tip of the speaker cable so that the wires do not stick out of the speaker terminal when connecting. If the exposed wires touch the rear panel, or the + side and - side wires touch each other, the protection circuit will be activated.

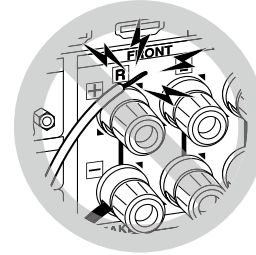

■ Connect the Subwoofer

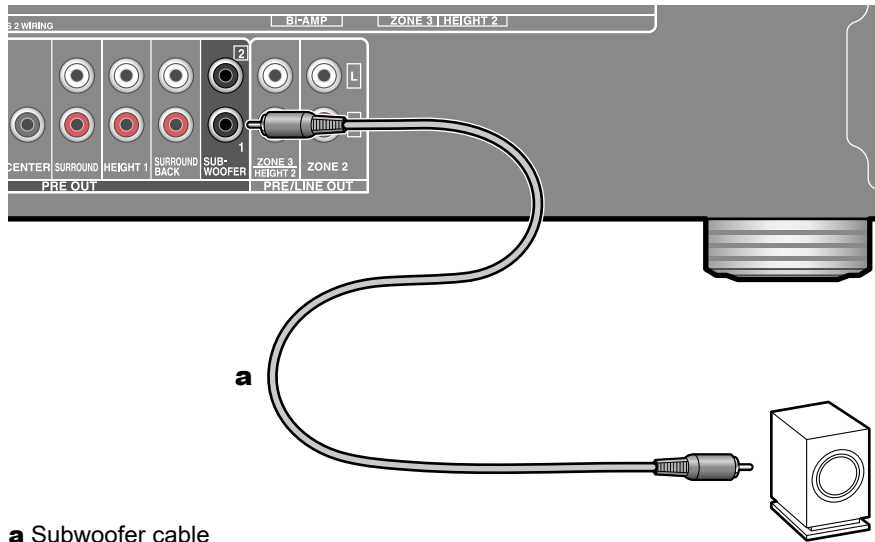

a Subwoofer cable

Connect a powered subwoofer with this unit using a subwoofer cable. Up to two powered subwoofers can be connected. The same signal is output from each SUBWOOFER PRE OUT jack.

■ 5.1 Channel System

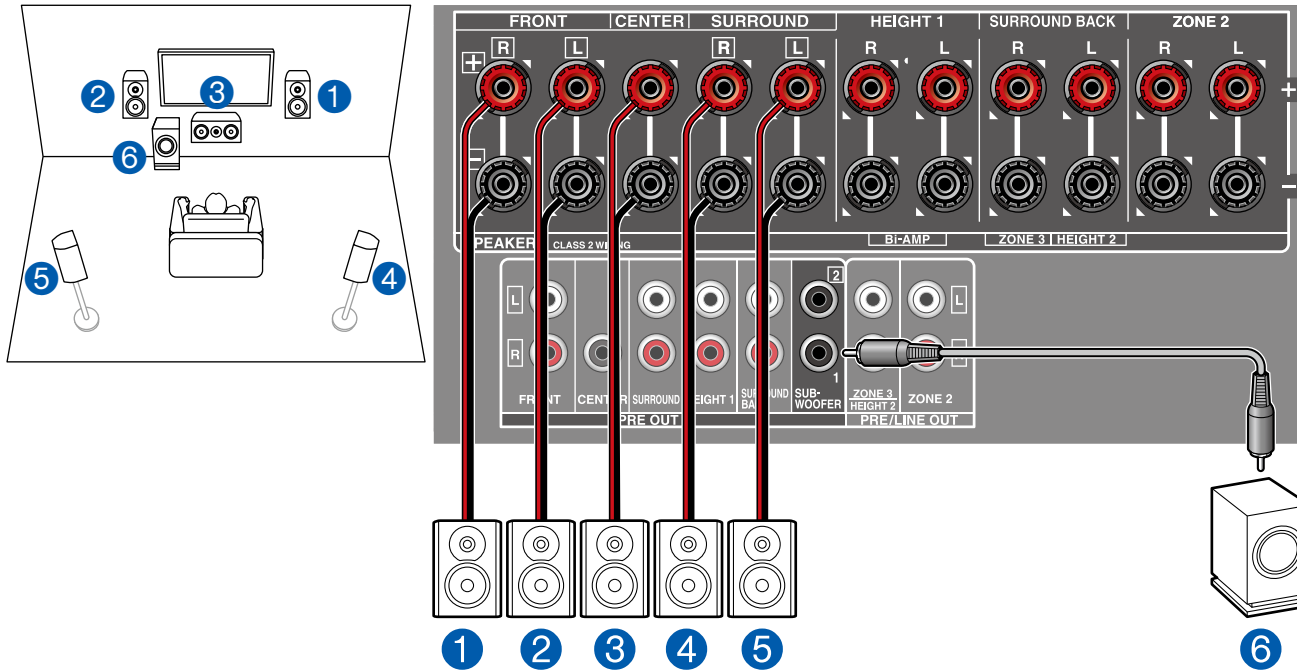

This is a basic 5.1 Channel System. For details of the speaker layout, refer to "Speaker Installation" (→p14).

■ "Speaker Setup" settings during Initial Setup (→p157)

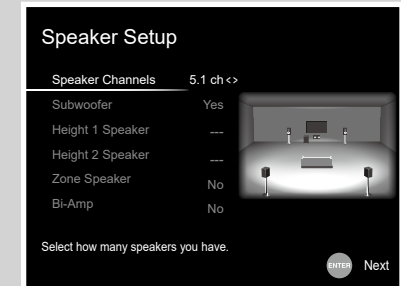

- Speaker Channels: 5.1 ch
- Subwoofer: Yes
- Height 1 Speaker: ---
- Height 2 Speaker: ---
- Zone Speaker: No
- Bi-Amp: No

■ 5.1 Channel System + ZONE SPEAKER

MAIN ROOM

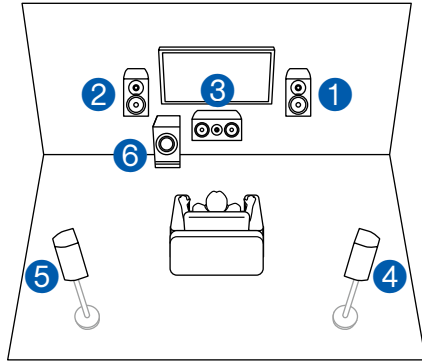

ZONE 2

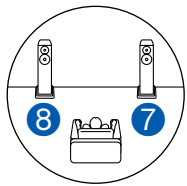

ZONE 3

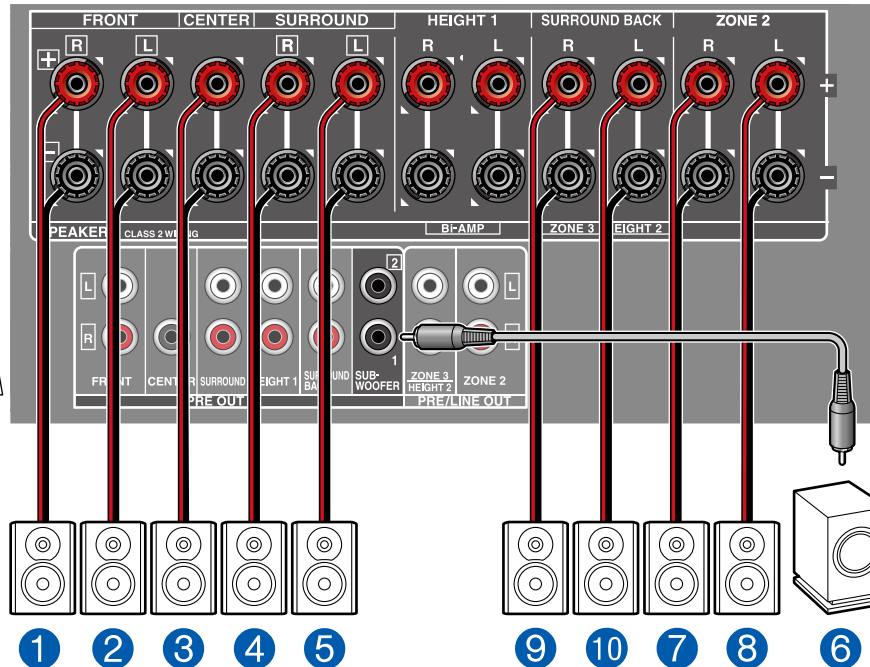
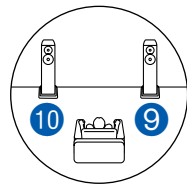

■ "Speaker Setup" settings during Initial Setup (→p157)



- Speaker Channels: 5.1 ch
- Subwoofer: Yes
- Height 1 Speaker: ---
- Height 2 Speaker: ---
- Zone Speaker: Zone 2 or Zone 2/
Zone 3
- Bi-Amp: No

MAIN ROOM: This is a basic 5.1 Channel System. For details of the speaker layout, refer to "Speaker Installation" (→p14).

ZONE 2/ZONE 3: You can enjoy 2-ch audio in the separate room (ZONE 2/ZONE 3) while performing 5.1-ch playback in the main room (where this unit is located). The same source can be played back in the main room and ZONE 2/ZONE 3 simultaneously. Also, different sources can be played back in both rooms.

To output audio from an externally connected AV component to ZONE 3, use an analog audio cable for connection. Note that ZONE 3 output is not possible with the connection using a HDMI cable, digital coaxial cable, or digital optical cable.

■ 5.1 Channel System (Bi-Amping the Speakers)

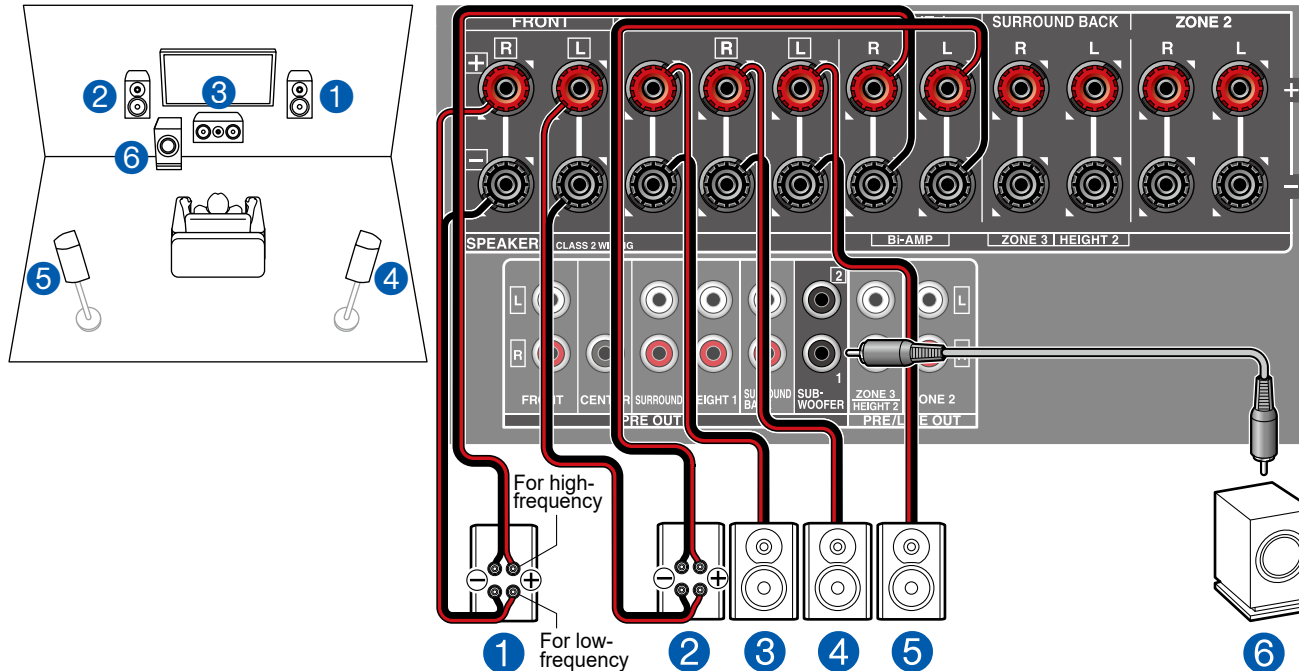

You can configure a 5.1 Channel System (→p14) by connecting front speakers that support Bi-Amping connection. The Bi-Amping connection can improve the quality of the low and high pitched ranges. Be sure to remove the jumper bar connecting between the woofer jacks and tweeter jacks of the Bi-Amping supported speakers. Refer to the instruction manual of your speakers as well.

■ "Speaker Setup" settings during Initial Setup (→p157)



- Speaker Channels: 5.1 ch
- Subwoofer: Yes
- Height 1 Speaker: ---
- Height 2 Speaker: ---
- Zone Speaker: No
- Bi-Amp: Yes

7.1 Channel System

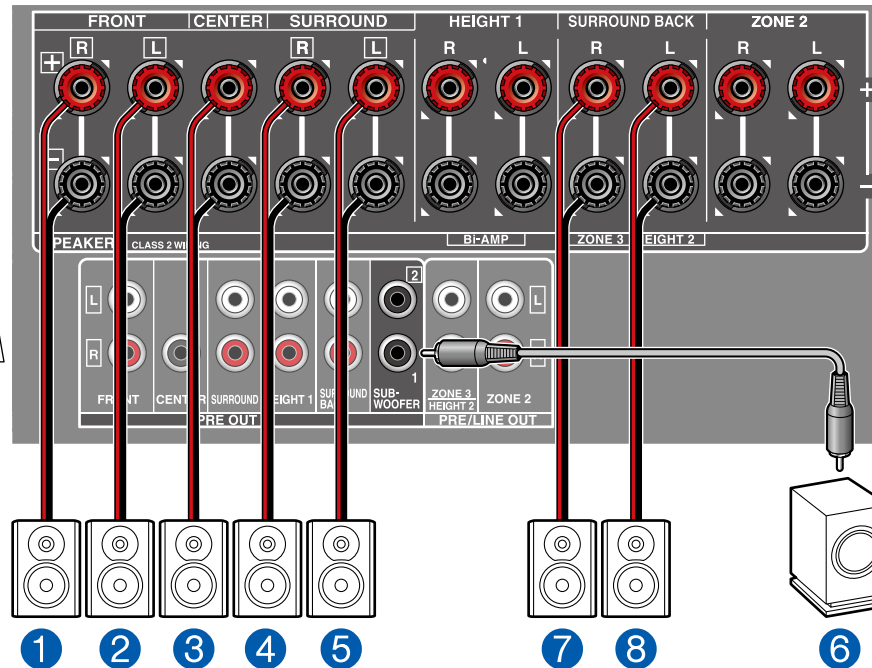
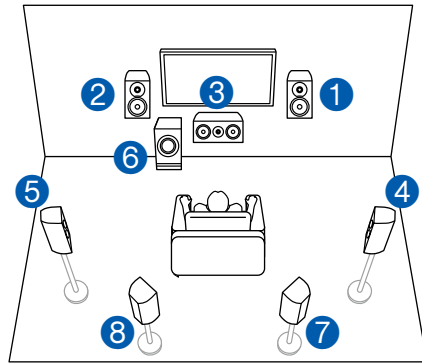

"Speaker Setup" settings during Initial Setup (→p157)



- Speaker Channels: 7.1 ch
- Subwoofer: Yes
- Height 1 Speaker: ---
- Height 2 Speaker: ---
- Zone Speaker: No
- Bi-Amp: No

This is a 7.1 Channel System that consists of the basic 5.1 Channel System and added surround back speakers. For details of the speaker layout, refer to "Speaker Installation" (→p15).

7.1 Channel System + ZONE SPEAKER

MAIN ROOM

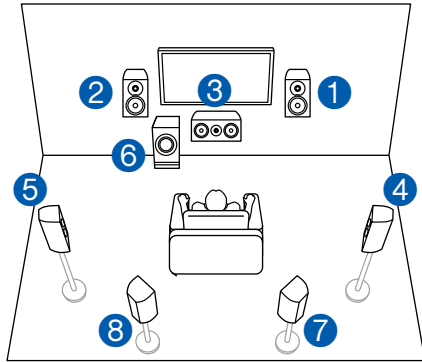

ZONE 2

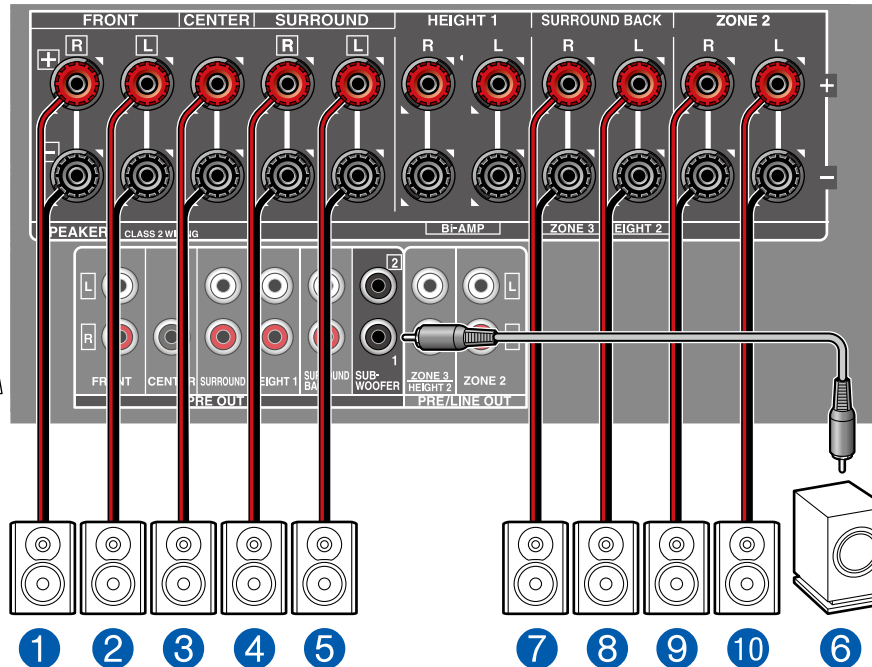
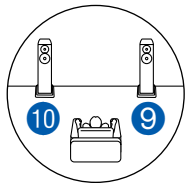

MAIN ROOM: This is a 7.1 Channel System that consists of the basic 5.1 Channel System and added surround back speakers. For details of the speaker layout, refer to "Speaker Installation" (→p15).

ZONE 2: You can enjoy 2-ch audio in the separate room (ZONE 2) while performing playback in the main room (where this unit is located). The same source can be played back in the main room and ZONE 2 simultaneously. Also, different sources can be played back in both rooms.

"Speaker Setup" settings during Initial Setup (→p157)



- Speaker Channels: 7.1 ch
- Subwoofer: Yes
- Height 1 Speaker: ---
- Height 2 Speaker: ---
- Zone Speaker: Zone 2
- Bi-Amp: No

7.1 Channel System(Bi-Amping the Speakers)

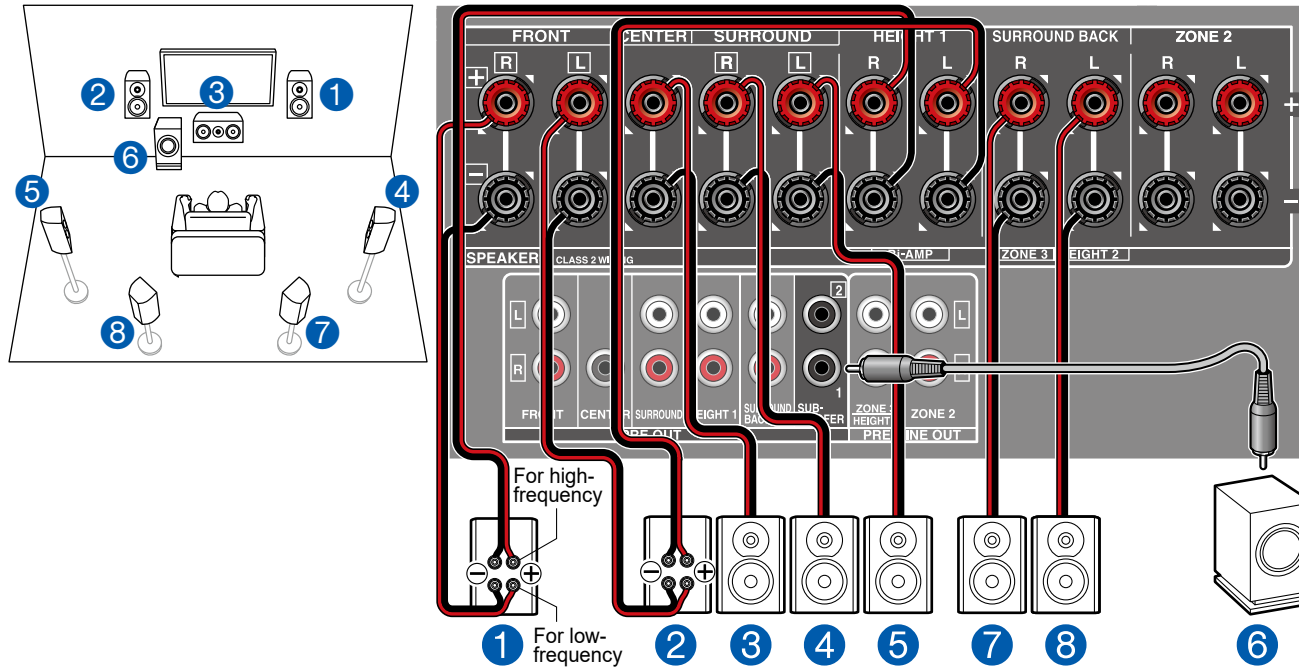

You can configure a 7.1 Channel System (→p15) by connecting front speakers that support Bi-Amping connection. The Bi-Amping connection can improve the quality of the low and high pitched ranges. Be sure to remove the jumper bar connecting between the woofer jacks and tweeter jacks of the Bi-Amping supported speakers. Refer to the instruction manual of your speakers as well.

"Speaker Setup" settings during Initial Setup (→p157)



- Speaker Channels: **7.1 ch**
- Subwoofer: **Yes**
- Height 1 Speaker: ---
- Height 2 Speaker: ---
- Zone Speaker: **No**
- Bi-Amp: **Yes**

5.1.2 Channel System

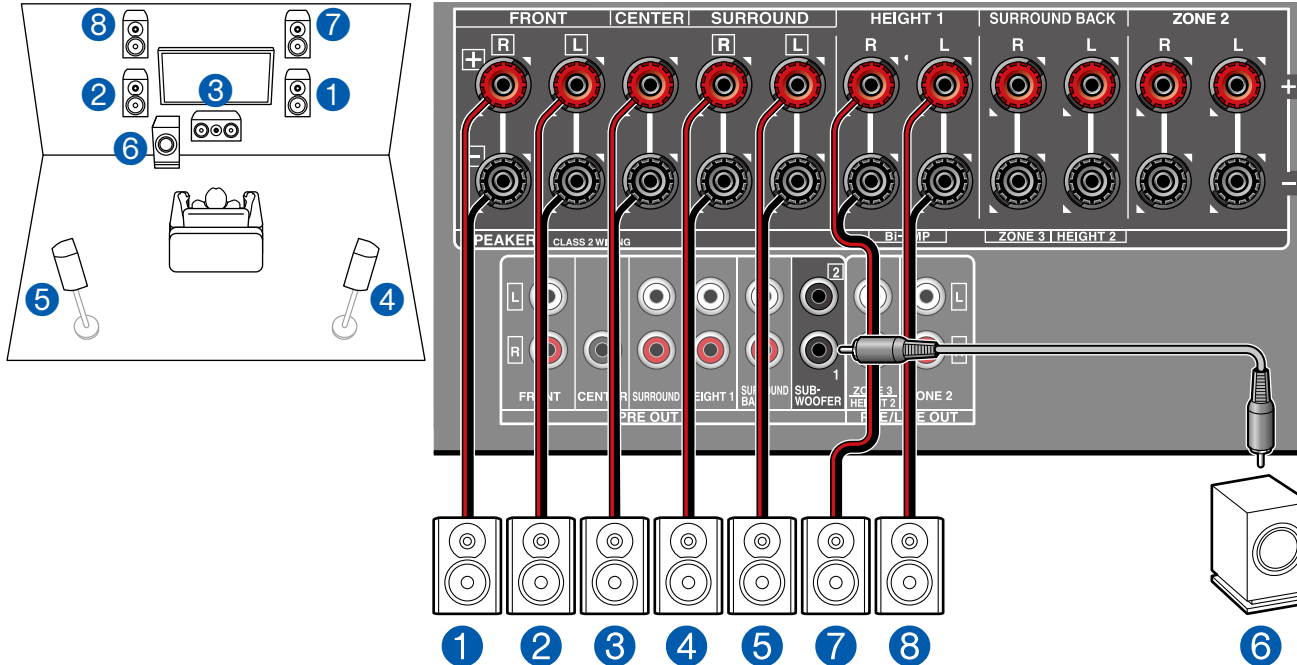

This is a combination of the 5.1 Channel System and front high speakers. A front high speaker is a type of height speaker. You can select only one set of height speakers from the following three types for connection.

- Front High Speakers/Rear High Speakers Installation Example (→p17)
- Ceiling Speakers Installation Example (→p18)
- Dolby Enabled Speakers (Dolby Speakers) Installation Example (→p19)

"Speaker Setup" settings during Initial Setup (→p157)

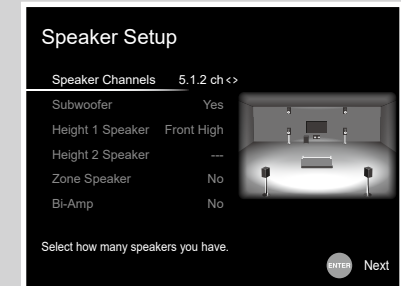

- Speaker Channels: 5.1.2 ch
- Subwoofer: Yes
- Height 1 Speaker: Select the type of height speaker actually installed.
- Height 2 Speaker: ---
- Zone Speaker: No
- Bi-Amp: No

5.1.2 Channel System + ZONE SPEAKER

MAIN ROOM

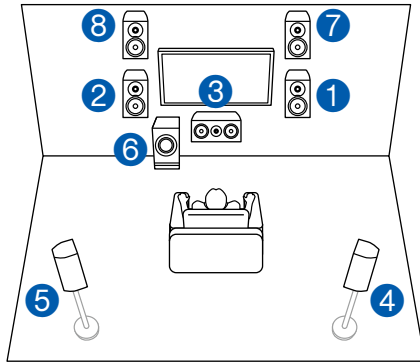

ZONE 2

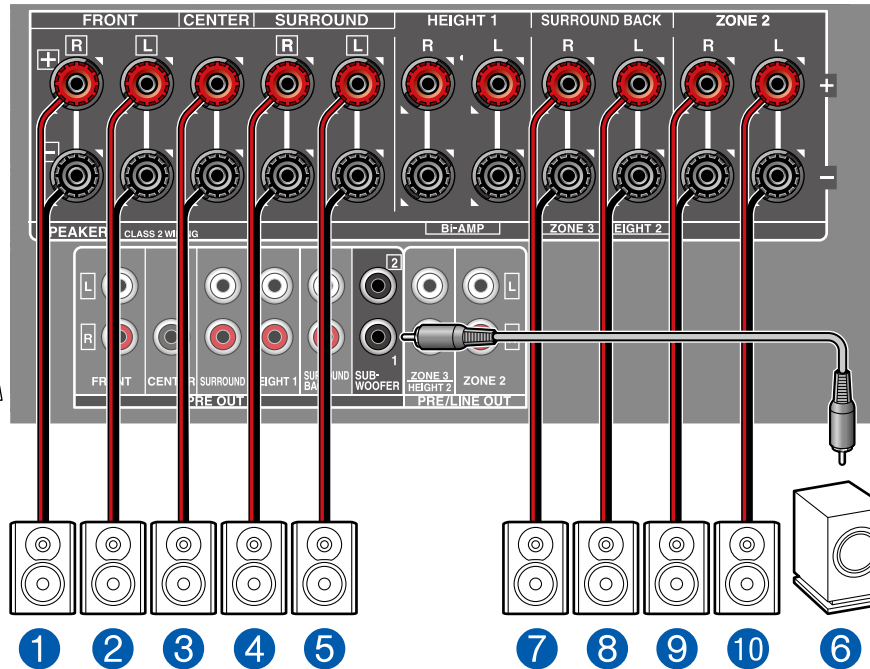
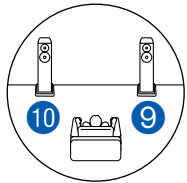

"Speaker Setup" settings during Initial Setup (→p157)

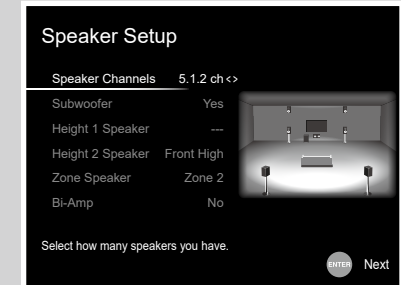

- Speaker Channels: 5.1.2 ch
- Subwoofer: Yes
- Height 1 Speaker: ---
- Height 2 Speaker: Select the type of height speaker actually installed.
- Zone Speaker: Zone 2
- Bi-Amp: No

MAIN ROOM: This is a combination of the 5.1 Channel System and front high speakers. A front high speaker is a type of height speaker. You can select only one set of height speakers from the following three types for connection.

- Front High Speakers/Rear High Speakers Installation Example (→p17)
- Ceiling Speakers Installation Example (→p18)
- Dolby Enabled Speakers (Dolby Speakers) Installation Example (→p19)

ZONE 2: You can enjoy 2-ch audio in the separate room (ZONE 2) while performing playback in the main room (where this unit is located). The same source can be played back in the main room and ZONE 2 simultaneously. Also, different sources can be played back in both rooms.

■ 5.1.2 Channel System(Bi-Amping the Speakers)

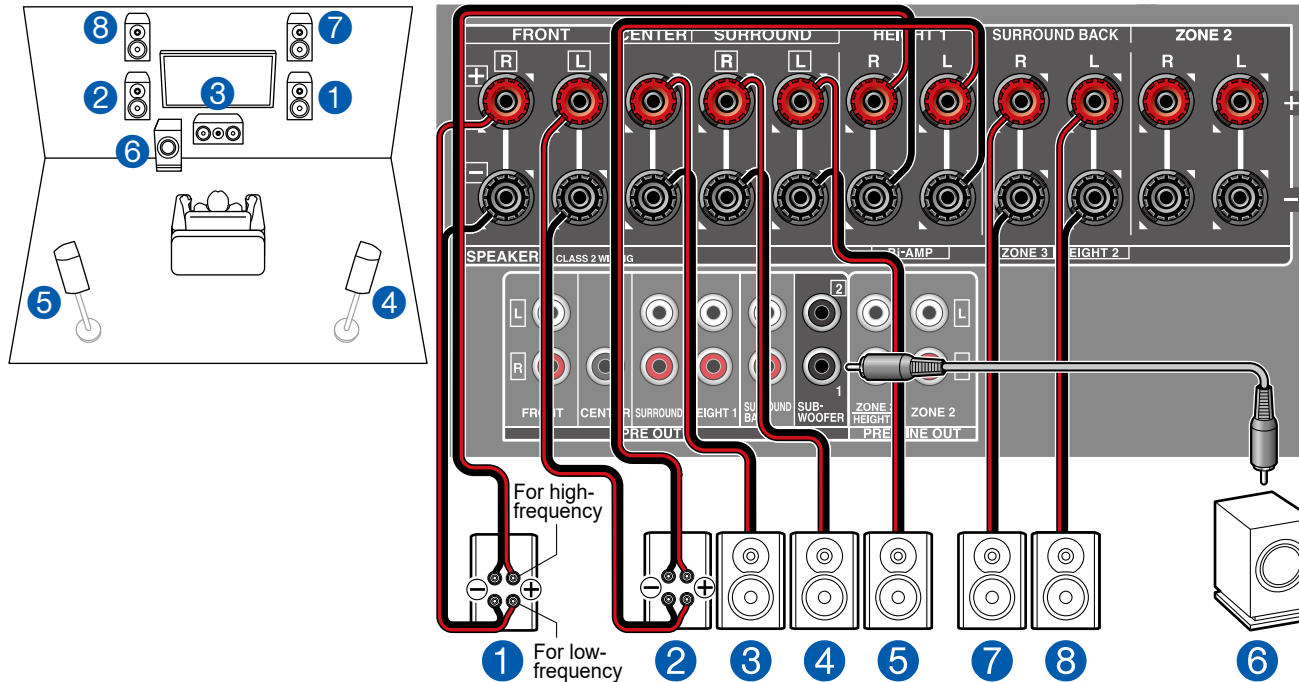

■ "Speaker Setup" settings during Initial Setup (→p157)

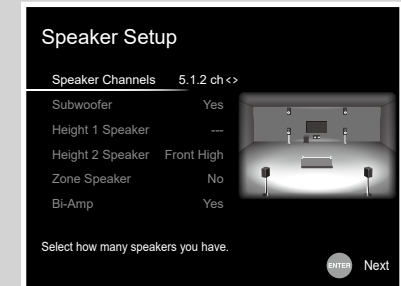

- Speaker Channels: 5.1.2 ch
- Subwoofer: Yes
- Height 1 Speaker: ---
- Height 2 Speaker: Select the type of height speaker actually installed.
- Zone Speaker: No
- Bi-Amp: Yes

This is a combination of the 5.1 Channel System and front high speakers. A front high speaker is a type of height speaker. You can select only one set of height speakers from the following three types for connection.

- Front High Speakers/Rear High Speakers Installation Example (→p17)
- Ceiling Speakers Installation Example (→p18)
- Dolby Enabled Speakers (Dolby Speakers) Installation Example (→p19)

You can configure a 5.1.2 Channel System by connecting front speakers that support Bi-Amping connection. The Bi-Amping connection can improve the quality of the low and high pitched ranges. Be sure to remove the jumper bar connecting between the woofer jacks and tweeter jacks of the Bi-Amping supported speakers. Refer to the instruction manual of your speakers as well.

7.1.2 Channel System

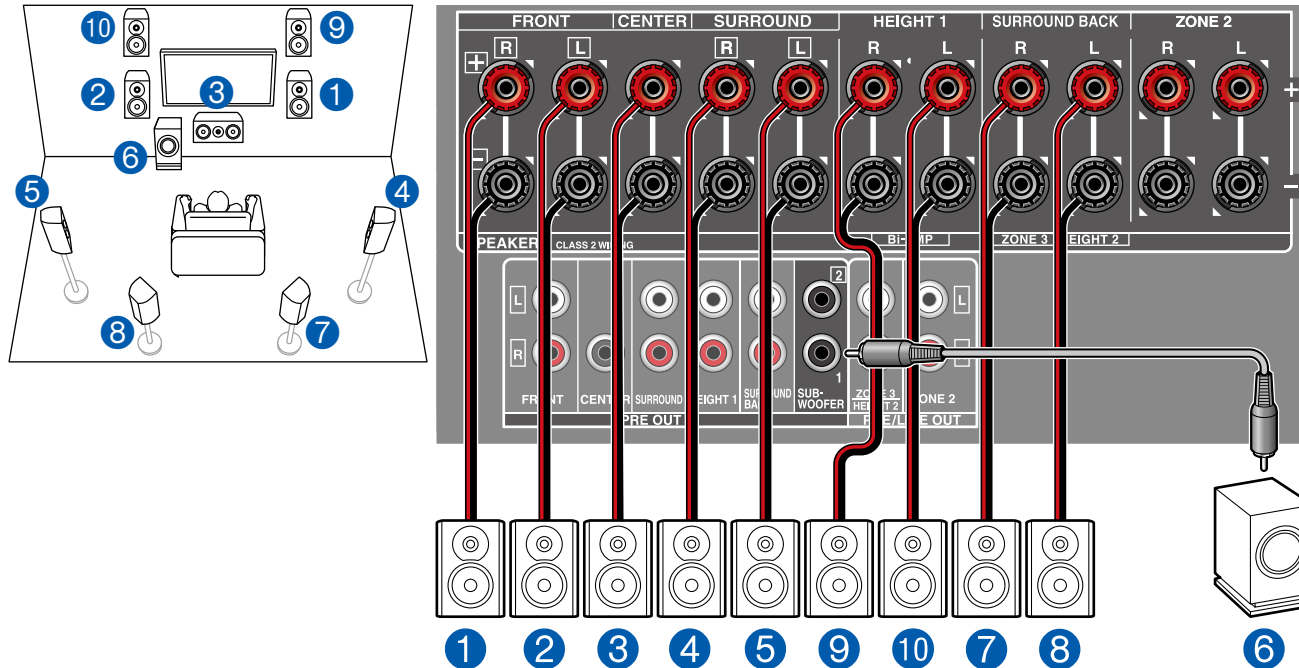

This is a combination of the 7.1 Channel System and front high speakers. A front high speaker is a type of height speaker. You can select only one set of height speakers from the following three types for connection.

- Front High Speakers/Rear High Speakers Installation Example (→p21)
- Ceiling Speakers Installation Example (→p22)
- Dolby Enabled Speakers (Dolby Speakers) Installation Example (→p23)

"Speaker Setup" settings during Initial Setup (→p157)

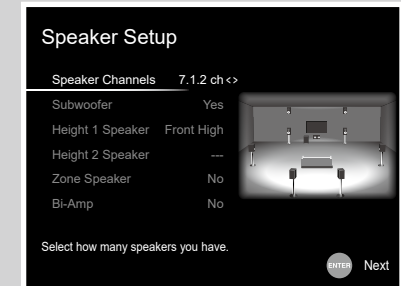

- Speaker Channels: 7.1.2 ch
- Subwoofer: Yes
- Height 1 Speaker: Select the type of height speaker actually installed.
- Height 2 Speaker: ---
- Zone Speaker: No
- Bi-Amp: No

7.1.2 Channel System + ZONE SPEAKER

MAIN ROOM

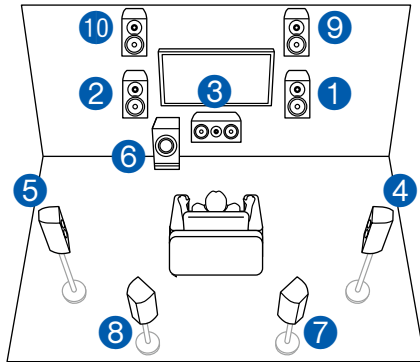

ZONE 2

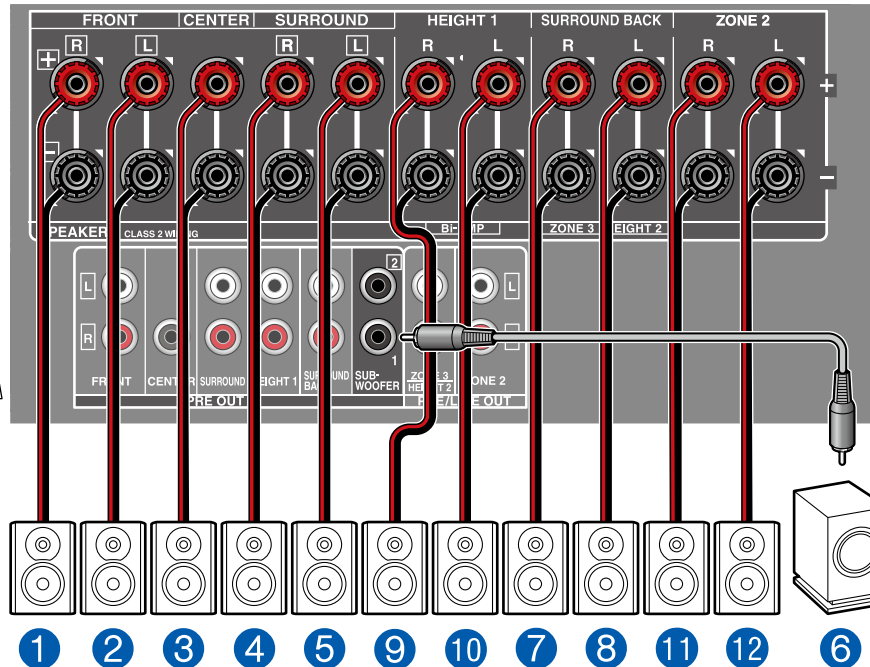
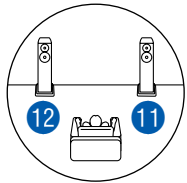

"Speaker Setup" settings during Initial Setup (→p157)

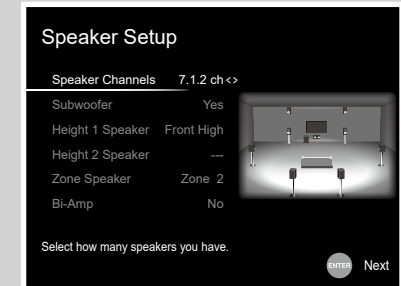

- Speaker Channels: 7.1.2 ch
- Subwoofer: Yes
- Height 1 Speaker: Select the type of height speaker actually installed.
- Height 2 Speaker: ---
- Zone Speaker: Zone 2
- Bi-Amp: No

MAIN ROOM: This is a combination of the 7.1 Channel System and front high speakers. A front high speaker is a type of height speaker. You can select only one set of height speakers from the following three types for connection.

- ❑ Front High Speakers/Rear High Speakers Installation Example (→p21)
- ❑ Ceiling Speakers Installation Example (→p22)
- ❑ Dolby Enabled Speakers (Dolby Speakers) Installation Example (→p23)

ZONE 2: You can enjoy 2-ch audio in the separate room (ZONE 2) while performing playback in the main room (where this unit is located). The same source can be played back in the main room and ZONE 2 simultaneously. Also, different sources can be played back in both rooms.

- While ZONE 2 playback is being performed, Height 1 speakers installed in the main room cannot play audio.

5.1.4 Channel System

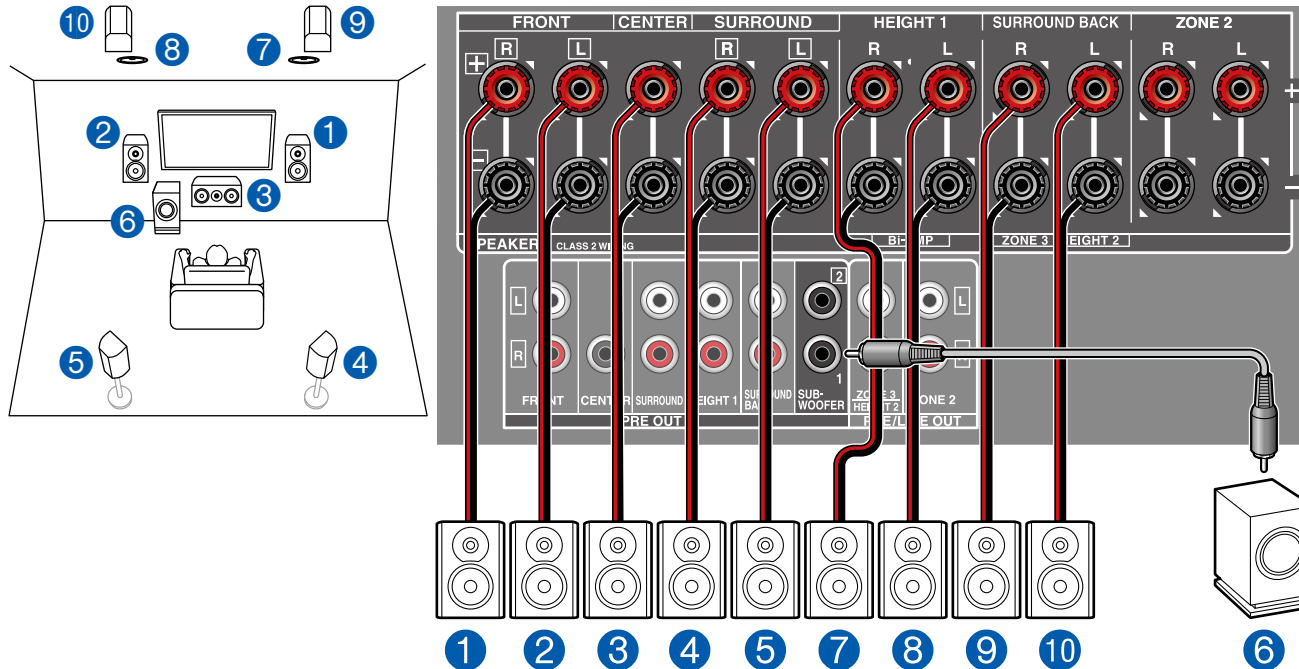

"Speaker Setup" settings during Initial Setup (→p157)



- Speaker Channels: 5.1.4 ch
- Subwoofer: Yes
- Height 1 Speaker: Select the type of height speaker actually installed.
- Height 2 Speaker: Select the type of height speaker actually installed.
- Zone Speaker: No
- Bi-Amp: No

This is an example of combining the top middle speakers at the front and the rear high speakers at the rear to the 5.1 Channel System. The height speakers in front can be selected from following 4 types. The height speakers that can be combined at the rear differ depending on the height speakers used at the front.

- ❑ Combination example when Top Front Speakers are used at the front (→p25)
- ❑ Combination example when Top Middle Speakers are used at the front (→p27)
- ❑ Combination example when Front High Speakers are used at the front (→p28)
- ❑ Combination example when Dolby Enabled Speakers (Front) are used at the front (→p30)

5.1.4 Channel System + ZONE SPEAKER

MAIN ROOM

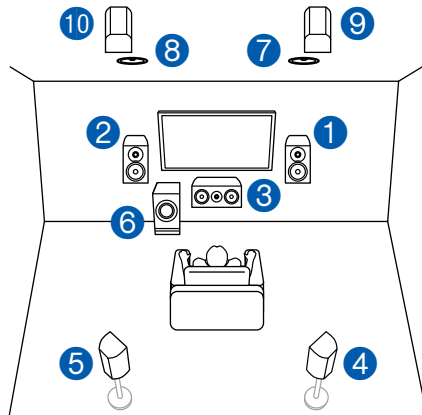

ZONE 2

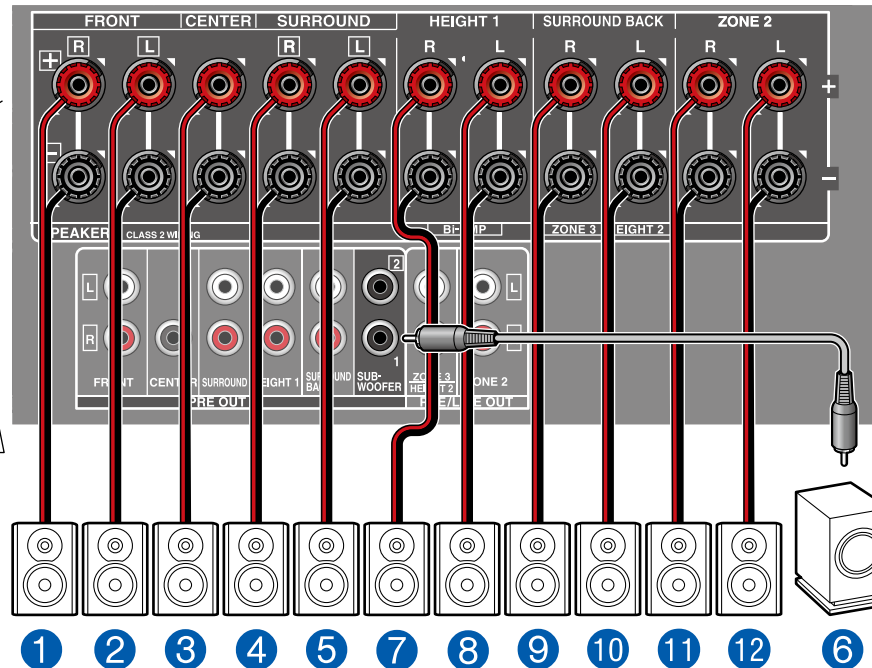
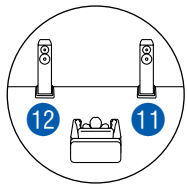

"Speaker Setup" settings during Initial Setup (→p157)

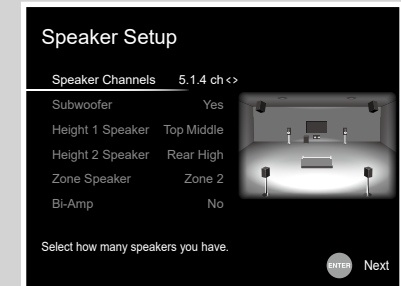

- Speaker Channels: 5.1.4 ch
- Subwoofer: Yes
- Height 1 Speaker: Select the type of height speaker actually installed.
- Height 2 Speaker: Select the type of height speaker actually installed.
- Zone Speaker: Zone 2
- Bi-Amp: No

MAIN ROOM: This is an example of combining the top middle speakers at the front and the rear high speakers at the rear to the 5.1 Channel System. The height speakers in front can be selected from following 4 types. The height speakers that can be combined at the rear differ depending on the height speakers used at the front.

- Combination example when Top Front Speakers are used at the front (→p25)
- Combination example when Top Middle Speakers are used at the front (→p27)
- Combination example when Front High Speakers are used at the front (→p28)
- Combination example when Dolby Enabled Speakers (Front) are used at the front (→p30)

ZONE 2: You can enjoy 2-ch audio in the separate room (ZONE 2) while performing playback in the main room (where this unit is located). The same source can be played back in the main room and ZONE 2 simultaneously. Also, different sources can be played back in both rooms.

- While ZONE 2 playback is being performed, Height 1 speakers installed in the main room cannot play audio.

7.1.4 Channel System

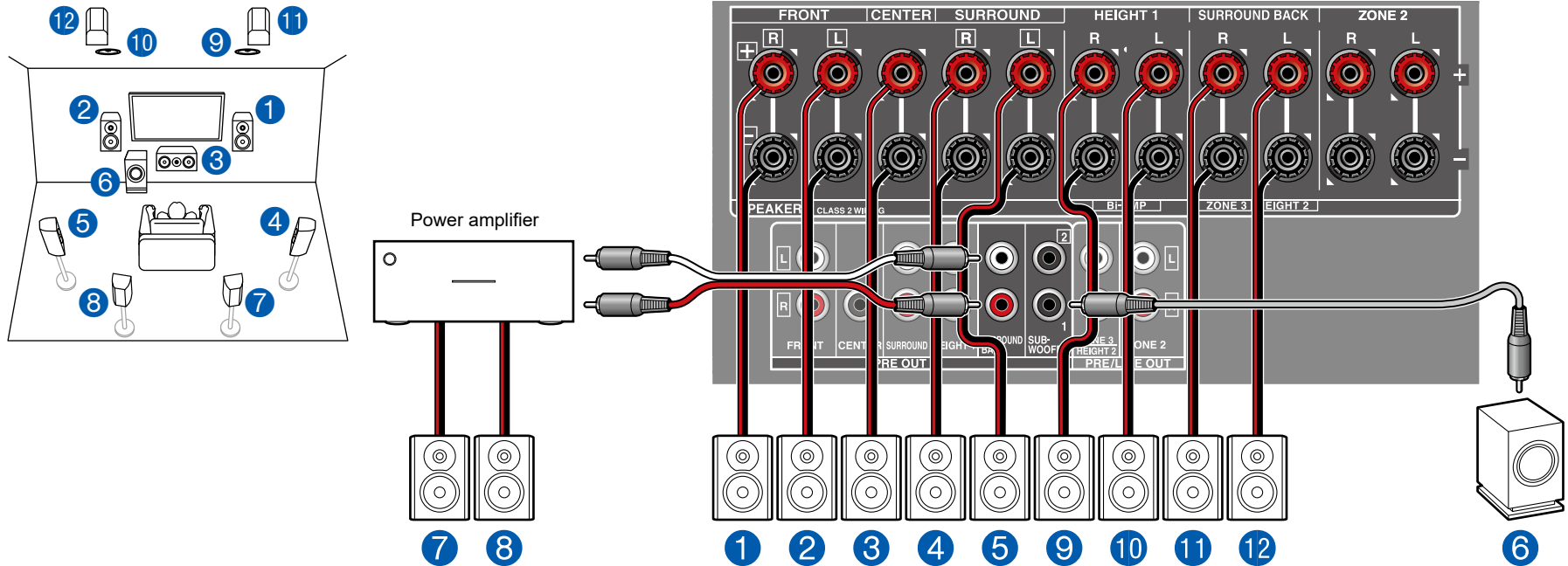

This is an example of combining the top middle speakers at the front and the rear high speakers at the rear to the 7.1 Channel System. The height speakers in front can be selected from following 4 types. The height speakers that can be combined at the rear differ depending on the height speakers used at the front.

- Combination example when Top Front Speakers are used at the front (→p33)
- Combination example when Top Middle Speakers are used at the front (→p35)
- Combination example when Front High Speakers are used at the front (→p36)
- Combination example when Dolby Enabled Speakers (Front) are used at the front (→p38)

■ "Speaker Setup" settings during Initial Setup (→p157)

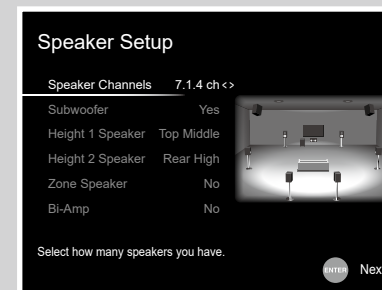

- Speaker Channels: 7.1.4 ch
- Subwoofer: **Yes**
- Height 1 Speaker: **Select the type of height speaker actually installed.**
- Height 2 Speaker: **Select the type of height speaker actually installed.**
- Zone Speaker: **No**
- Bi-Amp: **No**

7.1.4 Channel System + ZONE SPEAKER

MAIN ROOM

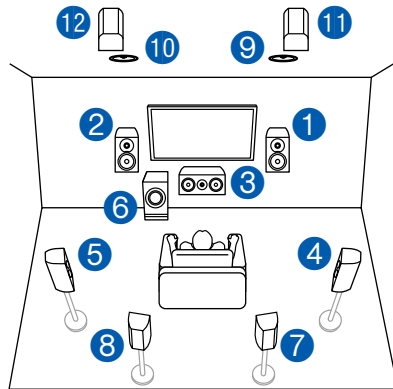

ZONE 2

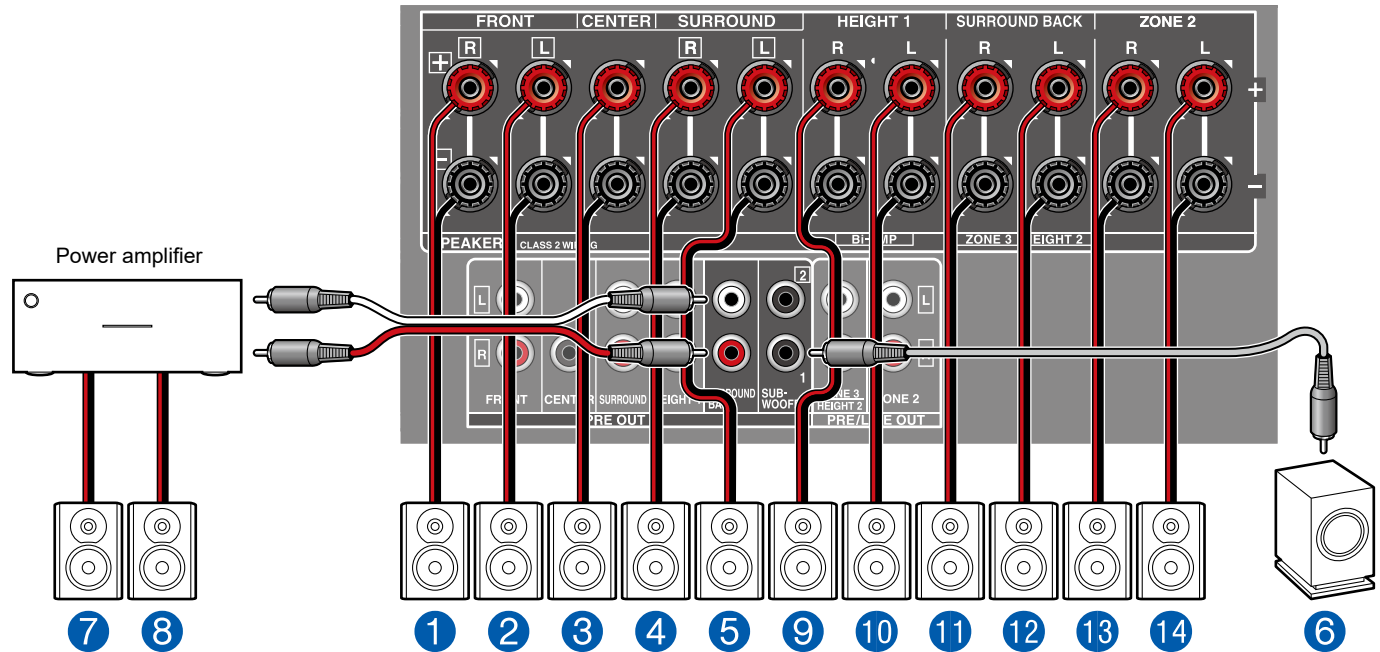
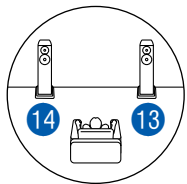

MAIN ROOM: This is an example of combining the top middle speakers at the front and the rear high speakers at the rear to the 7.1 Channel System. The height speakers in front can be selected from following 4 types. The height speakers that can be combined at the rear differ depending on the height speakers used at the front.

- Combination example when Top Front Speakers are used at the front (→p33)
- Combination example when Top Middle Speakers are used at the front (→p35)
- Combination example when Front High Speakers are used at the front (→p36)
- Combination example when Dolby Enabled Speakers (Front) are used at the front (→p38)

ZONE 2: You can enjoy 2-ch audio in the separate room (ZONE 2) while performing playback in the main room (where this unit is located). The same source can be played back in the main room and ZONE 2 simultaneously. Also, different sources can be played back in both rooms.

- While ZONE 2 playback is being performed, Height 1 speakers installed in the main room cannot play audio.

"Speaker Setup" settings during Initial Setup (→p157)

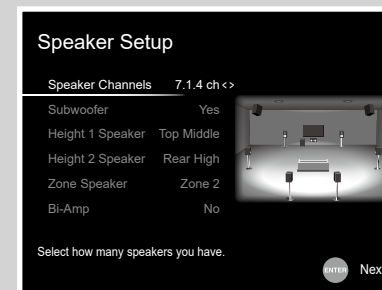

- Speaker Channels: 7.1.4 ch
- Subwoofer: **Yes**
- Height 1 Speaker: **Select the type of height speaker actually installed.**
- Height 2 Speaker: **Select the type of height speaker actually installed.**
- Zone Speaker: **Zone 2**
- Bi-Amp: **No**

Connecting a Power Amplifier

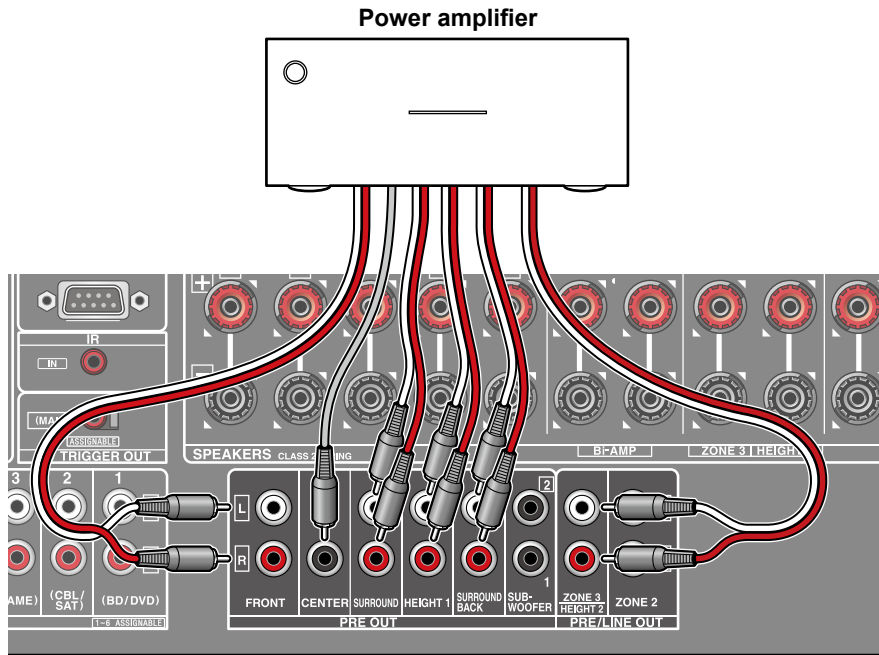

You can connect a power amplifier to the unit and use the unit as a pre-amplifier in order to produce a large volume that cannot be output with the unit only. Connect the speakers to the power amplifier. For details, refer to the power amplifier's instruction manual.

- Connect as shown on the left using the PRE OUT jacks.



Setup

- Set "2. Speaker" - "Configuration" - "Speaker Channels" in accordance to the number of channels for the connected speakers.

a Analog audio cable

Speaker combinations

- Up to two powered subwoofers can be connected in either combination.

Speaker Channels	FRONT	CENTER	SURROUND	SURROUND BACK	HEIGHT 1	HEIGHT 2	Bi-AMP (*1)	ZONE 2 (*1) (ZONE SPEAKER)	ZONE 3 (*1) (ZONE SPEAKER)
2.1 ch	✓						✓	✓	✓
3.1 ch	✓	✓					✓	✓	✓
4.1 ch	✓		✓				✓	✓	✓
5.1 ch	✓	✓	✓				✓	✓	✓
6.1 ch	✓		✓	✓			✓	✓	
7.1 ch	✓	✓	✓	✓			✓	✓	
2.1.2 ch	✓				✓ (*2) (*3)		✓ (*3)	✓ (*2)	✓ (*2)
3.1.2 ch	✓	✓			✓ (*2) (*3)		✓ (*3)	✓ (*2)	✓ (*2)
4.1.2 ch	✓		✓		✓ (*2) (*3)		✓ (*3)	✓ (*2)	✓ (*2)
5.1.2 ch	✓	✓	✓		✓ (*2) (*3)		✓ (*3)	✓ (*2)	✓ (*2)
6.1.2 ch	✓		✓	✓	✓ (*4)			✓ (*4)	
7.1.2 ch	✓	✓	✓	✓	✓ (*4)			✓ (*4)	
4.1.4 ch	✓		✓		✓ (*4)	✓		✓ (*4)	
5.1.4 ch	✓	✓	✓		✓ (*4)	✓		✓ (*4)	
6.1.4 ch	✓		✓	✓ (*5)	✓ (*4)	✓		✓ (*4)	
7.1.4 ch	✓	✓	✓	✓ (*5)	✓ (*4)	✓		✓ (*4)	

(*1) The Bi-AMP and ZONE speakers cannot be used simultaneously.

(*2) When using the ZONE 2 speakers (except when the ZONE 3 is used), it is necessary to connect the height speakers to the SURROUND BACK terminal. When using both the ZONE 2 speakers and the ZONE 3 speakers, the Height 1 speakers cannot be used simultaneously with the ZONE speakers.

(*3) When using the Bi-AMP speakers, it is necessary to connect the Bi-AMP speakers to the HEIGHT 1 terminals, and the height speaker to the SURROUND BACK terminals.

(*4) Height 1 speakers cannot be used simultaneously with the ZONE speakers.

(*5) Use an analog audio cable to connect the power amplifier to the PRE OUT SURROUND BACK jacks, then connect the surround back speakers to the power amplifier.

About the HEIGHT 1/HEIGHT 2

When connecting 2 sets of the height speakers, the combination of the height speakers that can be selected is as follows.

- Height 1 Speaker: Top Middle, Height 2 Speaker: Rear High
- Height 1 Speaker: Front High; Height 2 Speaker: One of Rear High/Top Middle/Top Rear/Dolby Enabled Speaker (Surround)/Dolby Enabled Speaker (Surround Back)
- Height 1 Speaker: Top Front or Dolby Enabled Speaker (Front), Height 2 Speaker: One of Rear High/Top Rear/Dolby Enabled Speaker (Surround)/Dolby Enabled Speaker (Surround Back)

When only 1 set of the height speakers is connected, 1 from the height speakers types can be selected.

Connecting the TV

Connect this unit between a TV and AV component. Connecting this unit with the TV can output the video and audio signals of the AV component to the TV, or play the audio of the TV on this unit. Connection with the TV differs depending on whether the TV supports the ARC (Audio Return Channel) function or not. The ARC function transmits the audio signals of the TV via an HDMI cable, and plays the audio of the TV on this unit. To check if the TV supports the ARC function, refer to the instruction manual of the TV, etc.

Does your TV support the ARC function?

Yes

• To ARC TV (→[p60](#))

No

• To Non-ARC TV (→[p61](#))

To ARC TV

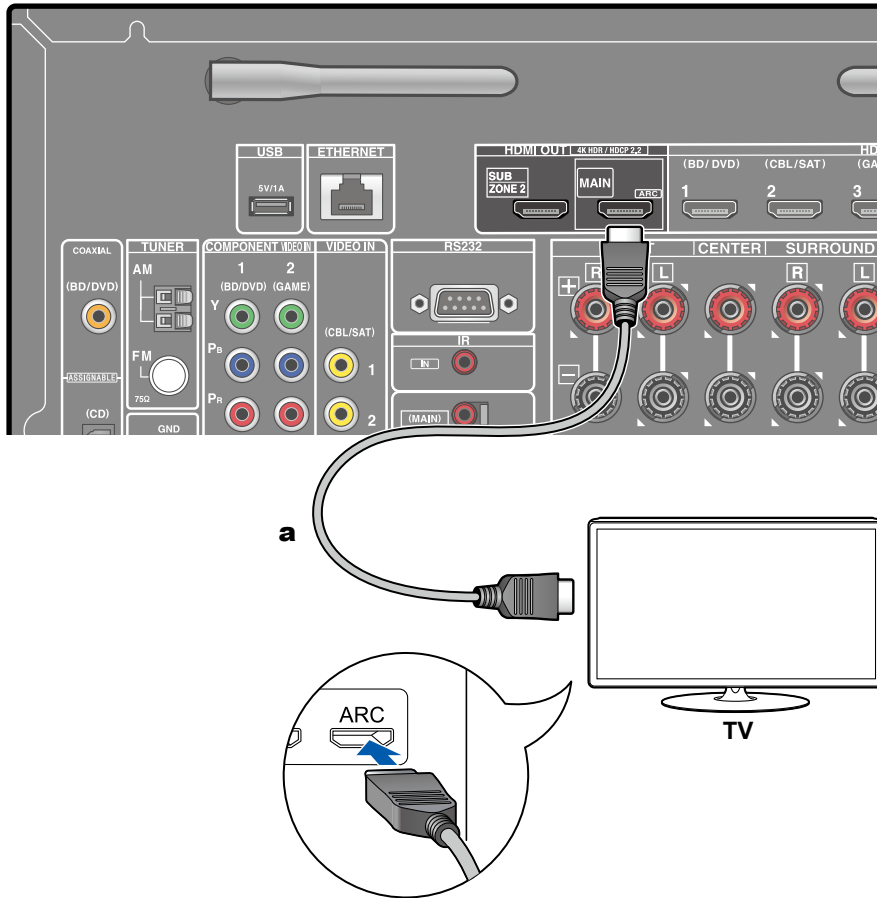

a HDMI cable

If the TV supports the ARC (Audio Return Channel) function (*), use only the HDMI cable to connect with the TV. Use the ARC-compatible HDMI IN jack of the TV for connection.

- Another TV or projector can be connected to the HDMI OUT SUB jack. To switch between MAIN and SUB, press the Q button (→[p148](#)) on the remote controller, and select "Other" - "HDMI Out". Note that this jack is not ARC-compatible.



Setup

- Settings are required to use the ARC function. Select "Yes" for "5. ARC Setup" in Initial Setup (→[p156](#)).
- For detailed settings for TV connection, CEC function and audio output, refer to the instruction manual of the TV.

(*) ARC function: This function transmits the audio signals of the TV via an HDMI cable, and plays the audio of the TV on this unit. Connection to an ARC-compatible TV is complete with one HDMI cable. To check if the TV supports the ARC function, refer to the instruction manual of the TV, etc.

To Non-ARC TV

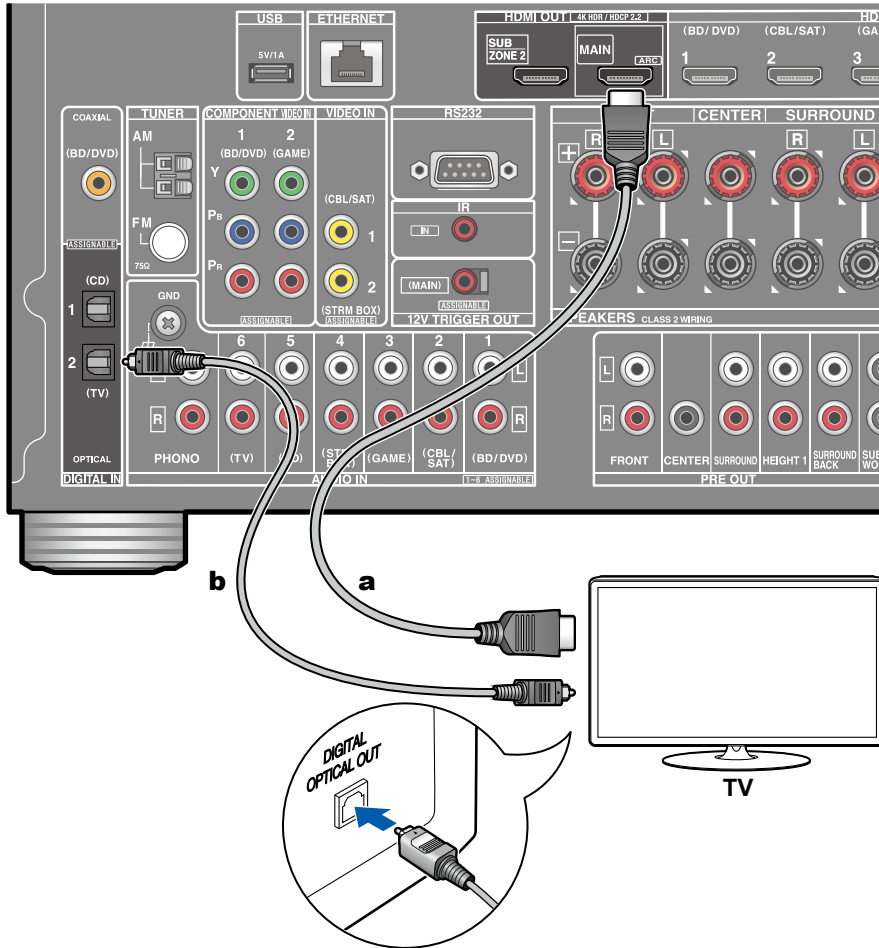

a HDMI cable, **b** Digital optical cable

If the TV does not support the ARC (Audio Return Channel) function (*), connect an HDMI cable and digital optical cable. If the TV does not have a DIGITAL OPTICAL OUT jack, you can use an analog audio cable to connect with the AUDIO IN TV jack.

- If you use a cable set-top box, etc. connected to the input jack of this unit to watch TV (without using a TV's built-in tuner), connection with a digital optical cable or analog audio cable is not required.
- Another TV or projector can be connected to the HDMI OUT SUB jack. To switch between MAIN and SUB, press the Q button (→p148) on the remote controller, and select "Other" - "HDMI Out". Note that this jack is not ARC-compatible.

(*) ARC function: This function transmits the audio signals of the TV via an HDMI cable, and plays the audio of the TV on this unit. Connection to an ARC-compatible TV is complete with one HDMI cable. To check if the TV supports the ARC function, refer to the instruction manual of the TV, etc.

Connecting Playback Devices

Connecting an AV Component with HDMI Jack Mounted

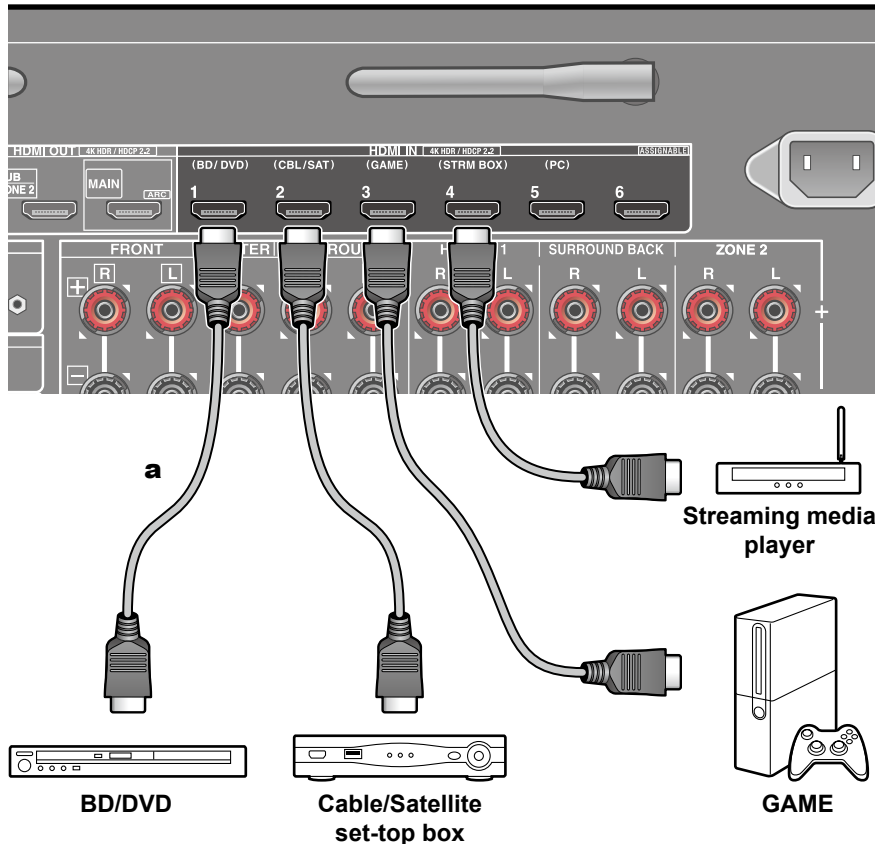

a HDMI cable

This is a connection example of an AV component equipped with an HDMI jack. When connecting with an AV component that conforms to the CEC (Consumer Electronics Control) standard, you can use the HDMI CEC function (*) that enables linking with input selectors, etc. and the HDMI Standby Through function that can transmit video and audio signals of the AV component to the TV even if this unit is in standby mode.

- To play 4K or 1080p video, use a high speed HDMI cable.



Setup

- The HDMI CEC function and HDMI Standby Through function are automatically enabled if you select "Yes" for "5. ARC Setup" in Initial Setup (→p156). If "No, Skip" is selected, settings are required in the Setup menu after Initial Setup is completed. Press  on the remote controller, and select "5. Hardware" - "HDMI" to make the settings. (→p141)
- To enjoy digital surround sound including Dolby Digital, set the audio output of the connected Blu-ray Disc player etc. to the Bitstream output.

(*)The HDMI CEC function: This function enables various linking operations with CEC-compliant devices, such as switching input selectors interlocking with a CEC-compliant player, switching audio output between TV and this unit or adjusting the volume using the remote controller of a CEC-compliant TV, and automatically switching this unit to standby when the TV is turned off.

Connecting an AV Component without HDMI Jack Mounted

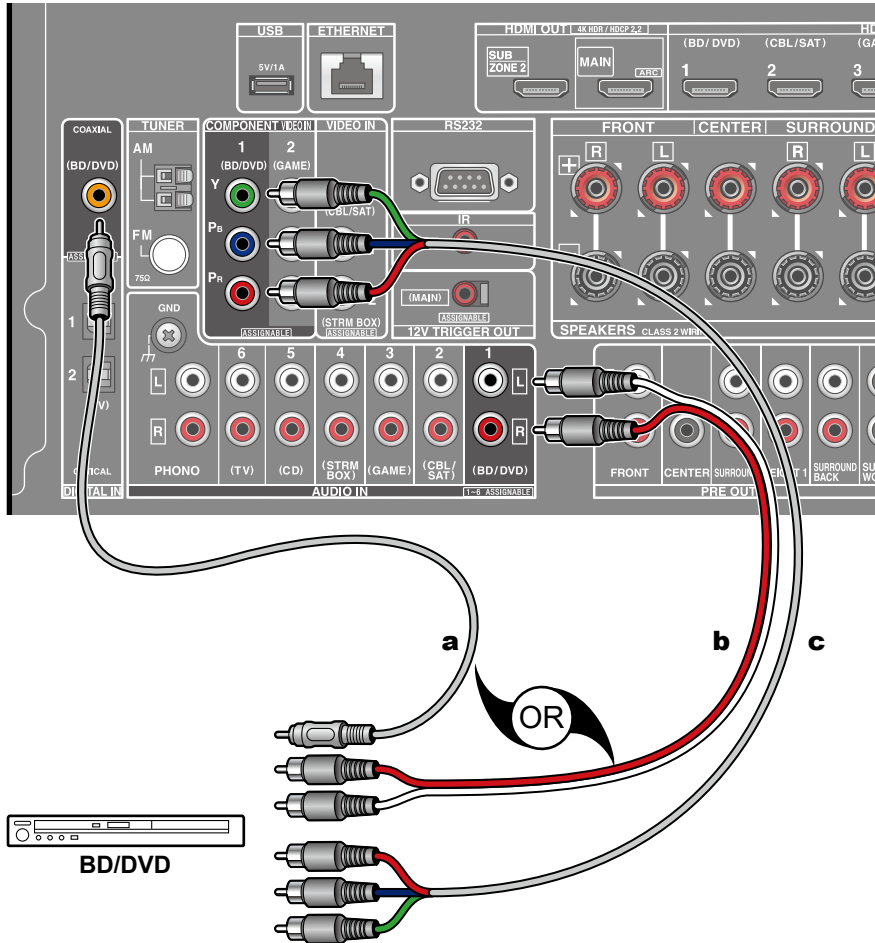

a Digital coaxial cable, **b** Analog audio cable, **c** Component video cable

This is a connection example of an AV component unequipped with an HDMI jack. Select cables that match the jacks of the AV component for connection. For example, when video input is connected to the BD/DVD jack, connect the audio input to BD/DVD jack, too. Thus, video input jacks and audio input jacks should have the same name for connection. Note that video signals input to the VIDEO IN jack or the COMPONENT VIDEO IN jack are converted to HDMI video signals, and then output from the HDMI OUT jack.

- To enjoy digital surround playback in formats such as Dolby Digital, you need to make a connection for audio signals with a digital coaxial cable or a digital optical cable.
- According to the illustration, changing the input assignment (→[p130](#)) enables connection to jacks other than the BD/DVD jack.



Setup

- The COMPONENT VIDEO IN jacks are compatible only with 480i or 576i resolution. When connecting to the COMPONENT VIDEO IN jacks, set the output resolution of the player to 480i or 576i. If there is no option such as 480i, select interlace. If your player does not support 480i or 576i output, use the VIDEO IN jack.
- To enjoy digital surround sound including Dolby Digital, set the audio output of the connected Blu-ray Disc player etc. to the Bitstream output.

Connecting an Audio Component

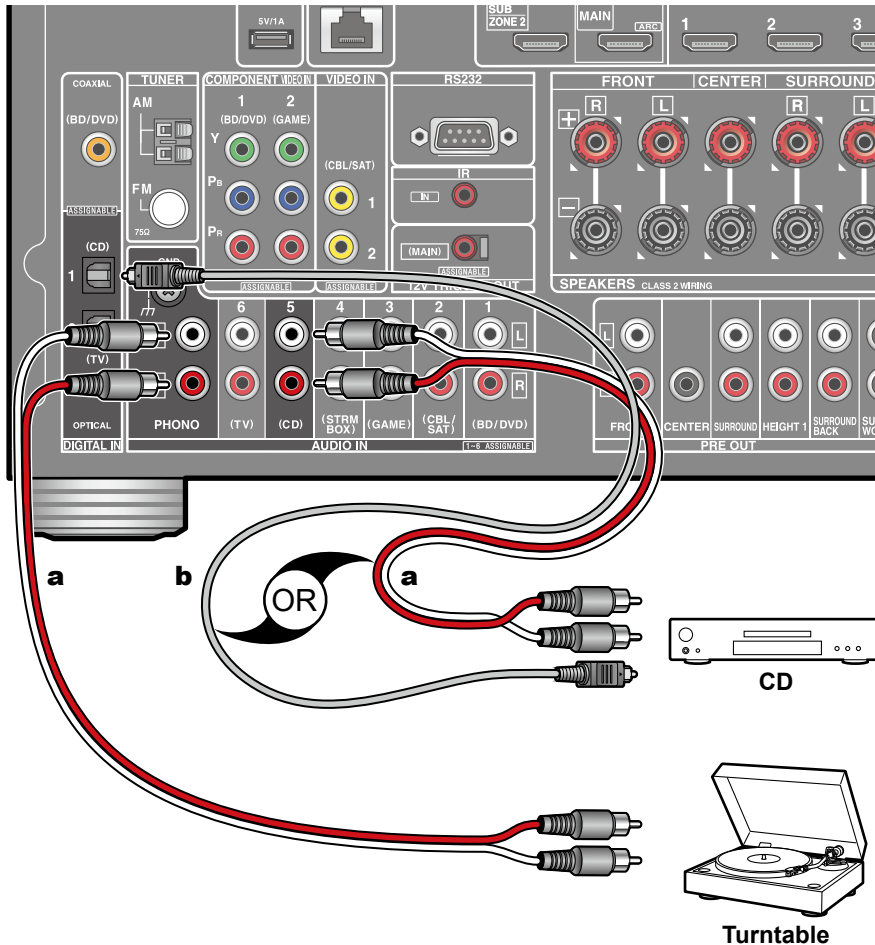

a Analog audio cable , **b** Digital optical cable

This is a connection example of an audio component. Connect a CD player using a digital optical cable or analog audio cable. You can also connect a turntable that has an MM-type cartridge to the PHONO jack.

- If the turntable has a built-in phono equalizer, connect it to any of the AUDIO IN jacks other than the PHONO jack. Further, if the turntable uses an MC type cartridge, install a phono equalizer compatible with the MC type cartridge between the unit and the turntable, and then connect it to any of the AUDIO IN jacks other than the PHONO jack.

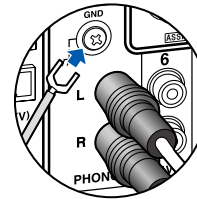

If the turntable has a ground wire, connect it to the GND terminal of this unit.

Connecting a Video Camera, etc.

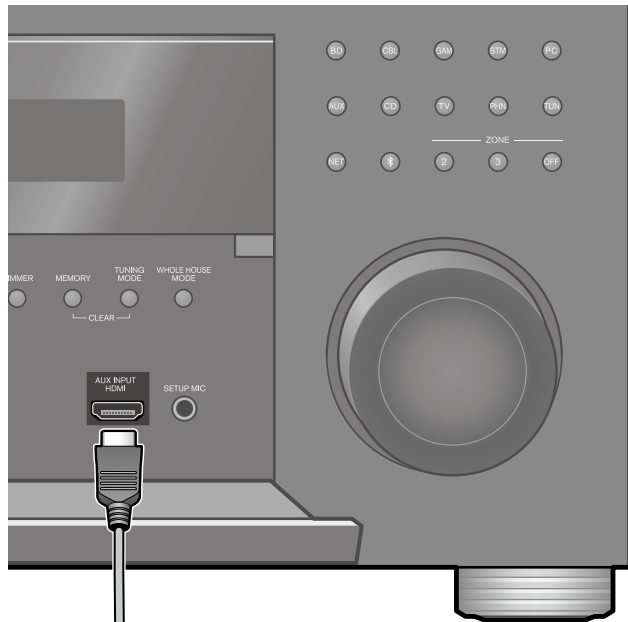

Connect a video camera, etc. to the AUX INPUT HDMI jack on the front panel using an HDMI cable.

a



Video camera

a HDMI cable

Connecting an AV Component in a Separate Room (Multi-zone Connection)

Connecting a TV (ZONE 2)

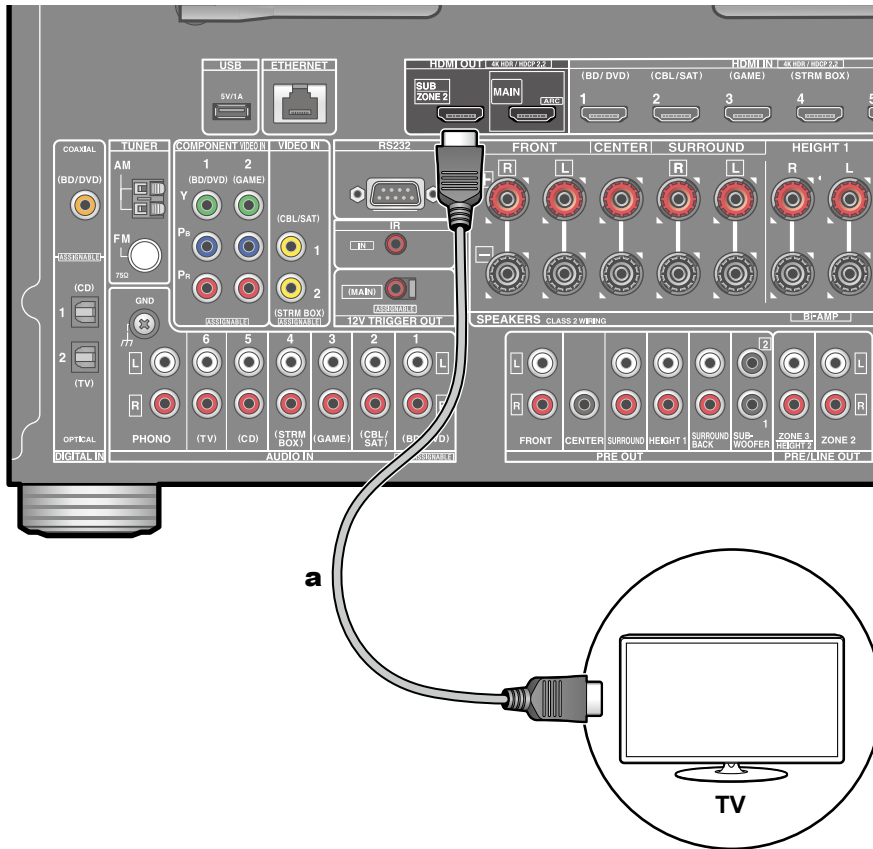

a HDMI cable

While a disc is played on a Blu-ray Disc player in the main room (where this unit is located), you can play the video and audio of the same Blu-ray Disc player or another AV component on the TV equipped with an HDMI IN jack in a separate room (ZONE 2). The TV in the separate room can play only the video of devices connected to the HDMI IN1 to IN3 jacks of this unit.

- The audio from externally connected AV components can be output only when the signal is 2ch PCM audio. It may also be necessary to convert the audio output of the AV component to PCM output.



Setup

- When video and audio via HDMI input are output to ZONE 2, set "1. Input/Output Assign" - "TV Out / OSD" - "Zone2 HDMI" (→[p128](#)) to "Use" on the Setup menu.

Connecting a Pre-main Amplifier (ZONE 2)

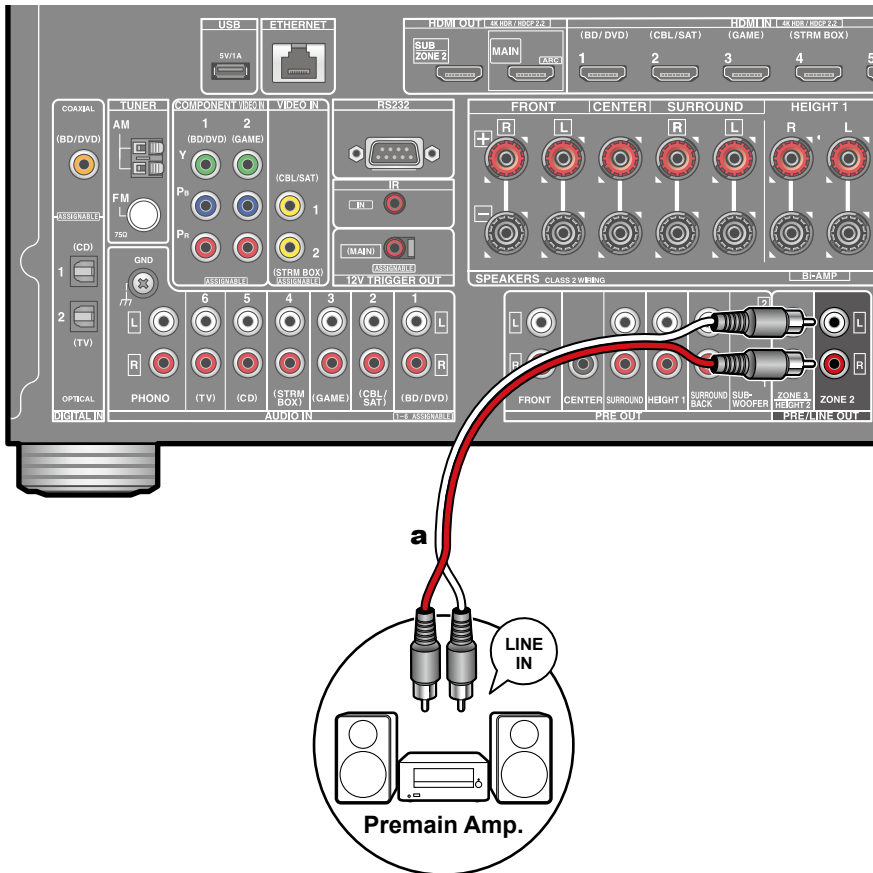

a Analog audio cable

You can enjoy 2-ch audio in the separate room (ZONE 2) while performing playback in the main room (where this unit is located). Use an analog cable to connect the ZONE 2 PRE/LINE OUT jack of this unit and the LINE IN jack of the pre-main amplifier or power amplifier in the separate room. The same source can be played back in the main room and ZONE 2 simultaneously. Also, different sources can be played back in both rooms.

- To output audio from an externally connected AV component to ZONE 2, connect it to any of HDMI IN1 to IN3 jacks. If the AV component is not equipped with an HDMI jack, use a digital coaxial cable, digital optical cable or analog audio cable. Also, the audio from externally connected AV components can be output to ZONE 2 only when the audio is analog or 2ch PCM signal. When the AV component is connected to this unit with an HDMI cable, digital coaxial cable or digital optical cable, change the audio output of the AV component to the PCM output.

Connecting a Pre-main Amplifier (ZONE 3)

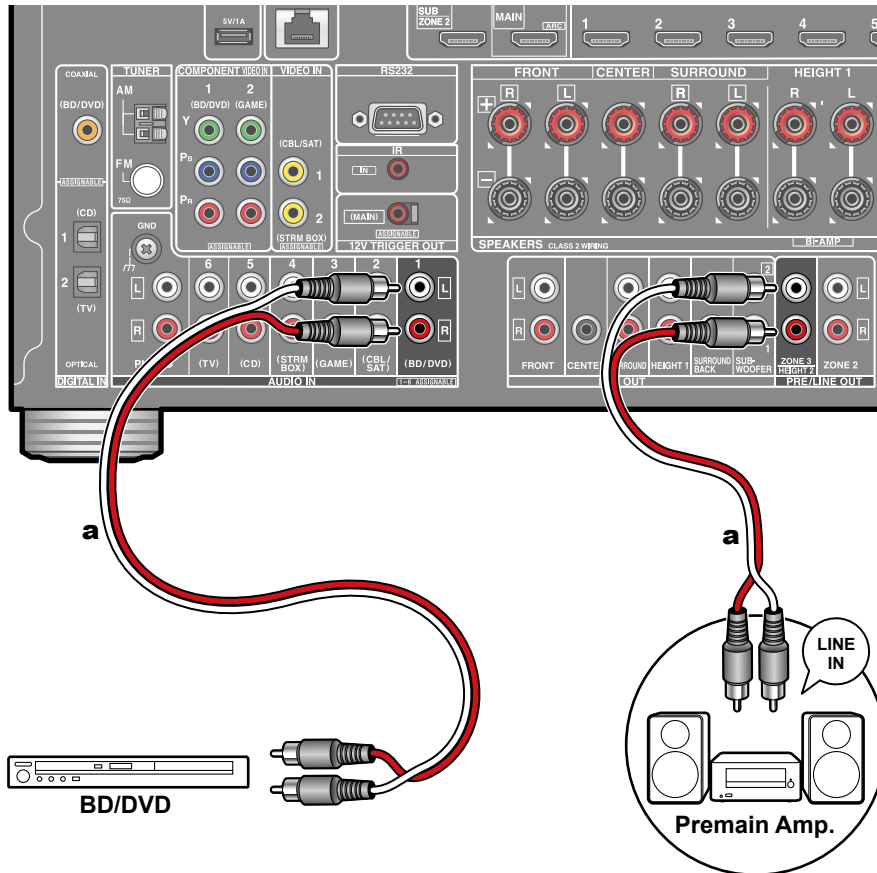

a Analog audio cable

You can enjoy 2-ch audio in the separate room (ZONE 3) while performing playback in the main room (where this unit is located). Use an analog cable to connect the ZONE 3 PRE/LINE OUT jack of this unit and the LINE IN jack of the pre-main amplifier or power amplifier in the separate room. The same source can be played back in the main room and ZONE 3 simultaneously. Also, different sources can be played back in both rooms.

- To output audio from an externally connected AV component to ZONE 3, use an analog audio cable for connection. Note that ZONE 3 output is not possible with the connection using a HDMI cable, digital coaxial cable, or digital optical cable.



Setup

- The ZONE 3 PRE/LINE OUT terminal can output only when "2. Speaker" - "Configuration" in the Setup menu (→[p132](#)) is set to one of the following.
 - When "Speaker Channels" is set to "2.1 ch", "3.1 ch", "4.1 ch", or "5.1 ch"
 - When "Speaker Channels" is set to "5.1 ch" or "5.1.2 ch", and "Zone Speaker" is set to "Zone 2/Zone 3"
 - When "Speaker Channels" is set to "2.1.2 ch", "3.1.2 ch", "4.1.2 ch", or "5.1.2 ch", and "Bi-Amp" and "Zone Speaker" is set to "No"

Connecting Antennas

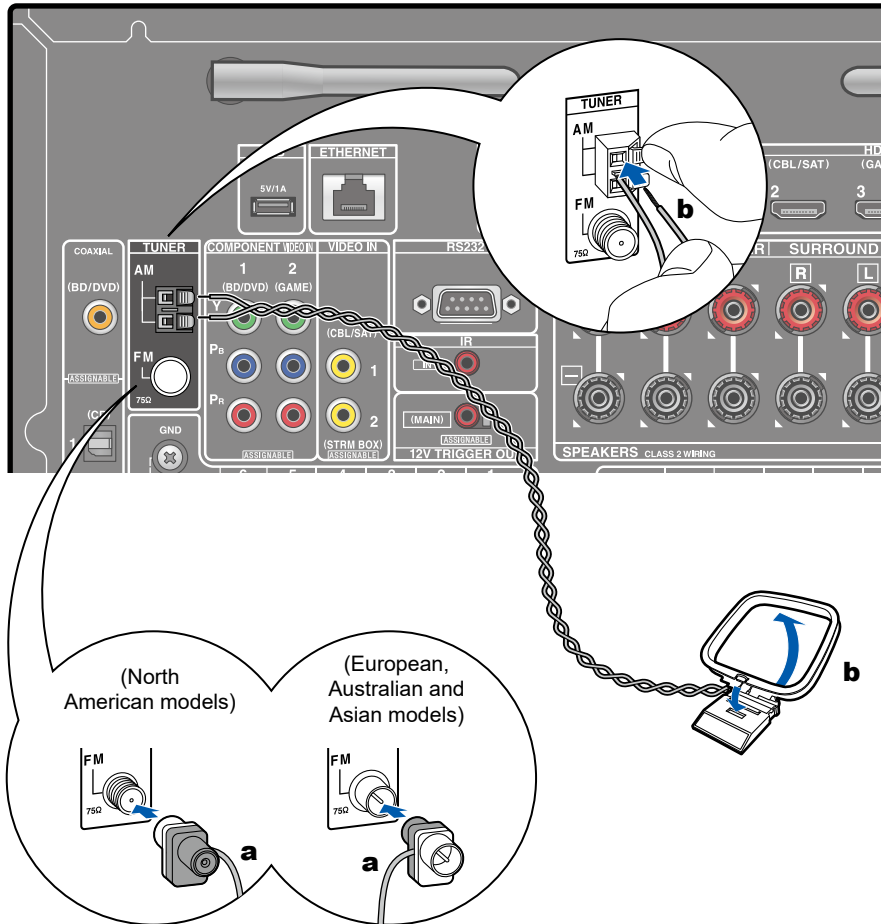

a Indoor FM antenna, **b** AM loop antenna

Connect the antenna to this unit, and set up the antenna at the best position for listening while receiving radio signals. Attach the indoor FM antenna to the wall using push pins or adhesive tape.

Network Connection

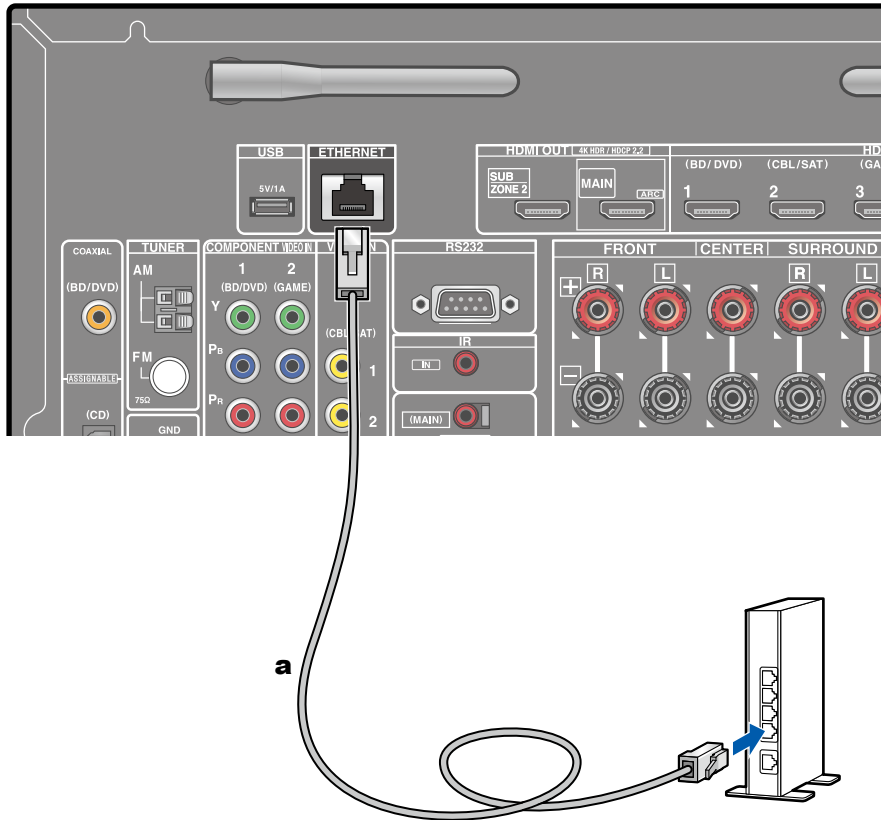

This unit can be connected to the network using a wired LAN or Wi-Fi (wireless LAN). You can enjoy network functions such as Internet radio by network connection. If connection is made by the wired LAN, connect the router and the ETHERNET jack with the LAN cable as shown in the illustration. To connect by Wi-Fi, select "Wireless" for "4. Network Connection" in Initial Setup (→[p158](#)), select your desired setting method, and then follow the on-screen instructions. For the Wi-Fi connection, stand the wireless antenna for use.

a LAN cable

Connecting External Control Devices

IR IN port

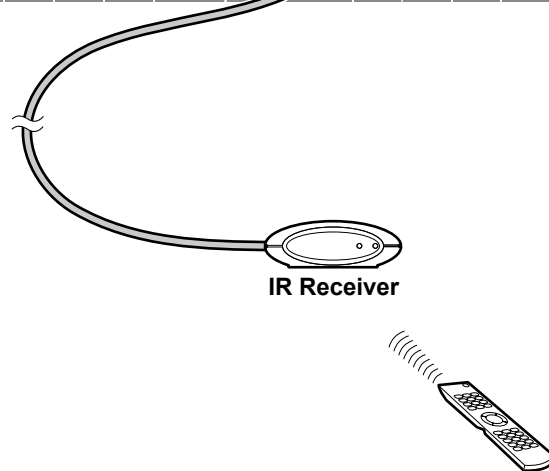
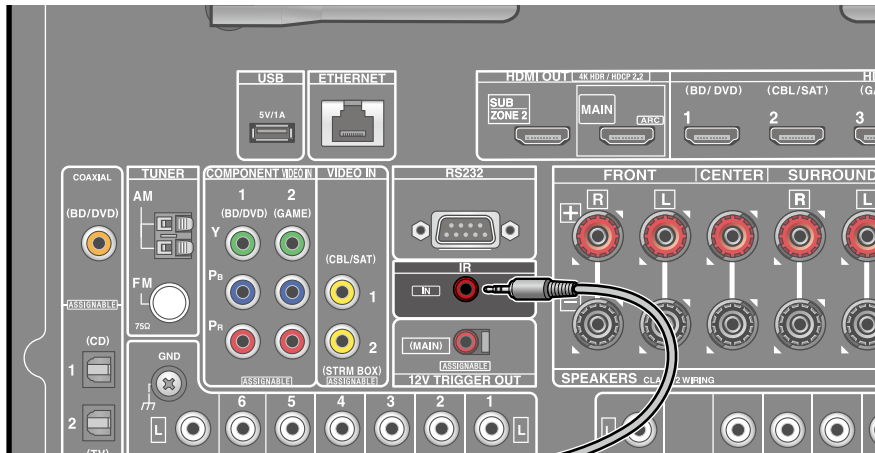

When connecting a remote control receiver unit consisting of an IR Receiver, etc. to this unit, operation using the remote controller is possible even if the remote control signal is difficult to reach (due to installation in the cabinet, etc.). You can also operate the unit using the remote controller from a separate room such as ZONE 2. For adopting a remote control receiver unit, contact the specialized stores.

- For the type of cable required for connection, refer to the operation manual, etc. of the remote control receiver unit.

12V TRIGGER OUT jack

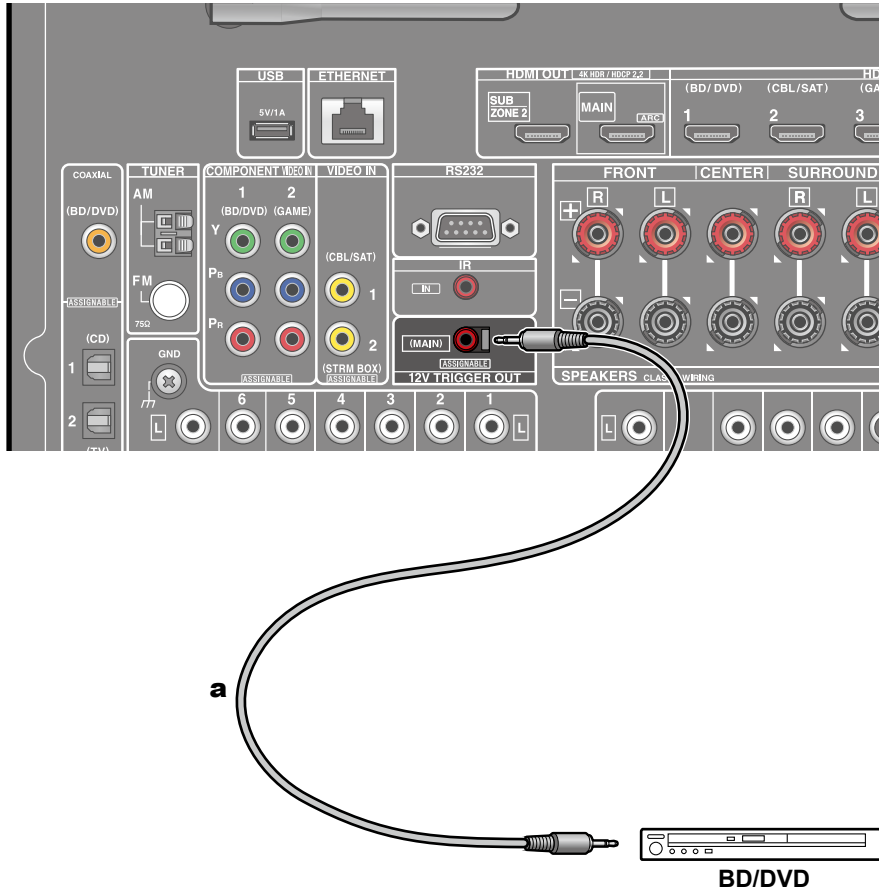

When connecting a device equipped with a TRIGGER IN jack such as a BD/DVD player to this unit, the device can be turned on or set to standby by interlocking the operation on this unit. When any input is selected, this unit outputs a maximum of 12 V/100 mA control signal from the 12V TRIGGER OUT jack, and controls the power link operation of the external device.

- For connection, use a monaural mini plug cable ($\phi 1/8''/3.5$ mm) without resistance. Do not use a stereo mini plug cable.

a Monaural mini plug cable ($\phi 1/8''/3.5$ mm)

Connecting the Power Cord

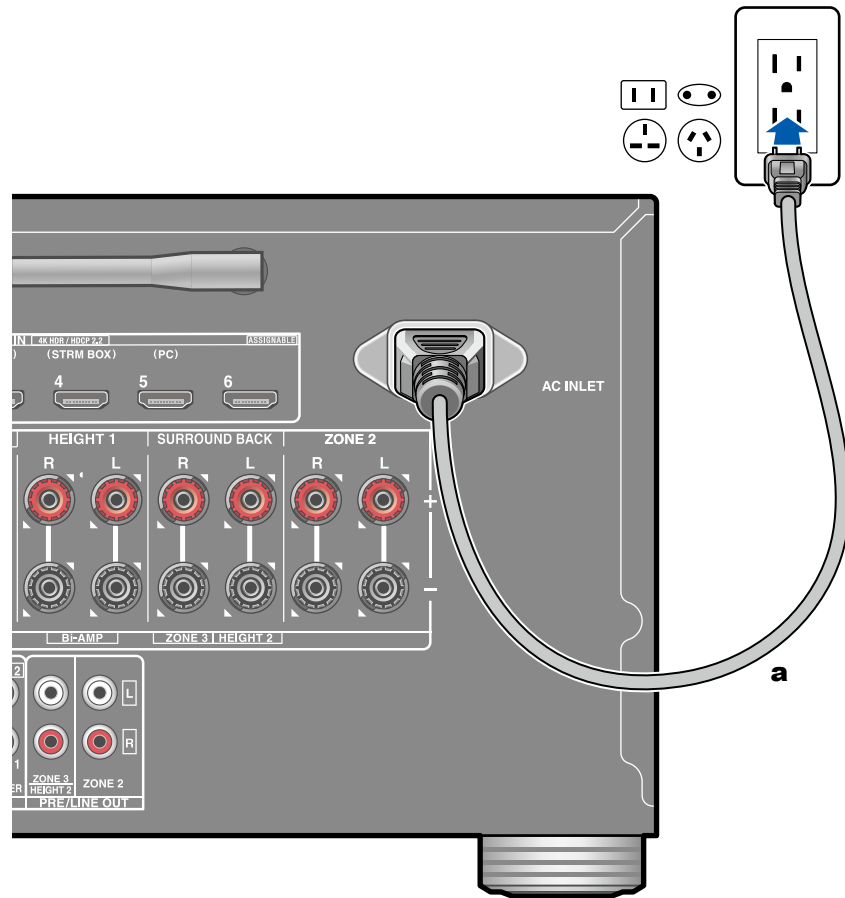

Connect the power cord after all the connections are completed.

- This unit includes a removable power cord. Be sure to connect the power cord to the AC INLET of the unit first, and then connect it to the outlet. Always disconnect the outlet side first when disconnecting the power cord.

a Power cord

Playback

AV Component Playback	75
BLUETOOTH® Playback	76
Internet Radio	77
Spotify	79
AirPlay®	80
DTS Play-Fi®	81
FlareConnect™	82
USB Storage Device	83
Playing back files on a PC and NAS (Music Server)	86
Play Queue	91
Listening To the AM/FM Radio	93
Multi-zone	98
Convenience functions	103
Listening Mode	105

AV Component Playback

You can play the audio from AV components, such as Blu-ray disc players through this unit.

- When a TV is connected to the HDMI OUT SUB jack, press Q, and select "Other" - "HDMI Out" to switch between MAIN and SUB.

Basic Operations

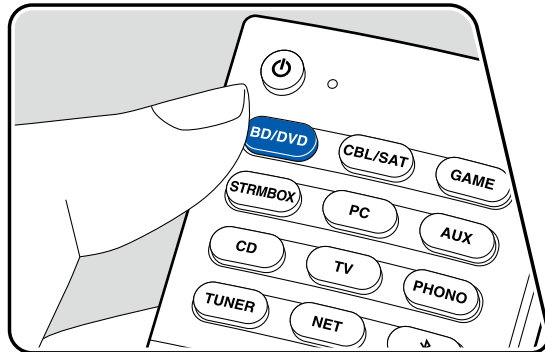
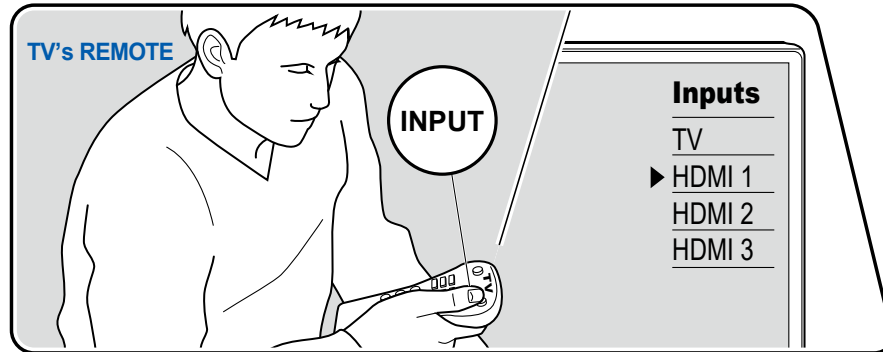

Perform the following procedure when this unit is on.

1. Switch the input on the TV to the input connected to the unit.
2. Press the input selector whose name is the same as that of the jack to which the player is connected.

For example, press BD/DVD to play the player connected to the BD/DVD jack. Press TV to listen the sound of the TV. Also, to play a device connected to the AUX INPUT AUDIO/HDMI jack on the front panel, press AUX.

- When the CEC link function works, the input switches automatically when a CEC compliant TV or player is connected to this unit using HDMI connection.

3. Start play on the AV component.

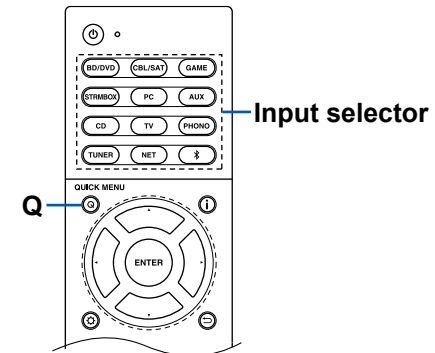

BLUETOOTH® Playback

You can wirelessly play the audio on a BLUETOOTH-enabled device, such as a smartphone.

Basic Operations

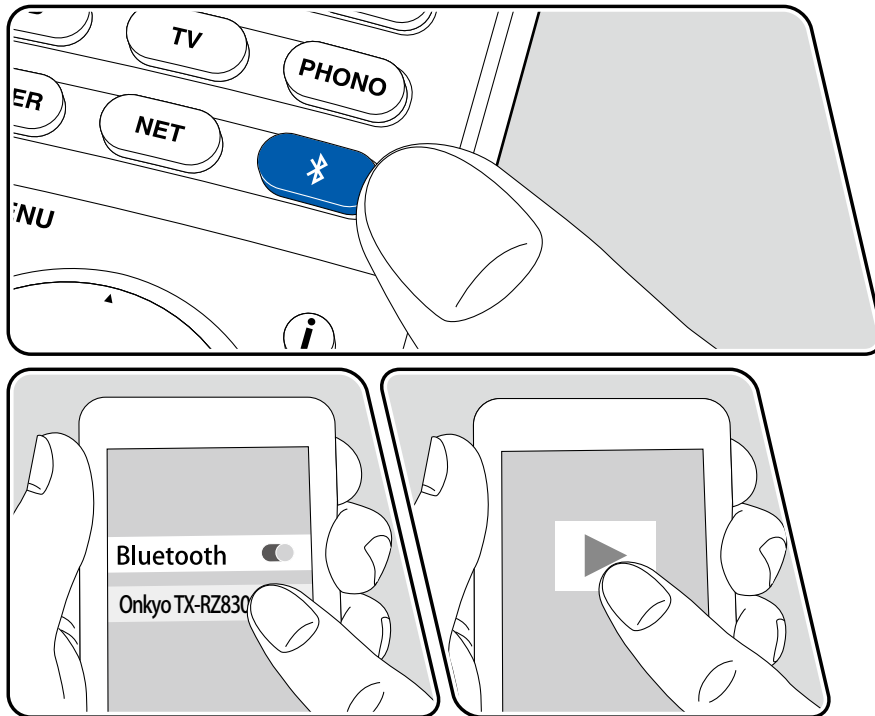

Perform the following procedure when this unit is on.

Pairing

1. When you press the  button, "Now Pairing..." is displayed on this unit's display, and the pairing mode is enabled.

Now Pairing...

2. Enable (turn on) the BLUETOOTH function of the BLUETOOTH-enabled device, and then select this unit from among the devices displayed. If a password is requested, enter "0000".
 - This unit is displayed as "Onkyo TX-RZ830 XXXXXX". This display can be changed with the Friendly Name function (→p143) or the Onkyo Controller App (can be used with the iOS or Android™).
 - To connect another BLUETOOTH-enabled device, press and hold the  button until "Now Pairing..." is displayed, and then perform step 2. This unit can store the pairing information of up to 8 paired devices.
 - The coverage area is approx. 48'/15 m. Note that connection is not always guaranteed with all BLUETOOTH-enabled devices.

Playing Back

1. Perform the connection procedure on the BLUETOOTH-enabled device. The input on this unit automatically switches to "BLUETOOTH".
2. Playing the music file. Turn up the volume of the BLUETOOTH-enabled device to an appropriate level.
 - Due to the characteristics of BLUETOOTH wireless technology, the sound produced on this unit may slightly be behind the sound played on the BLUETOOTH-enabled device.

Internet Radio

By connecting this unit to an Internet-connected network, you can enjoy Internet radio services, such as TuneIn Radio, etc.

- To play Internet radio services, the network needs to be connected to the Internet.
- Depending on the Internet radio service, a user registration may be required on your PC beforehand. For details of each service, visit the website of each service.

Playing Back

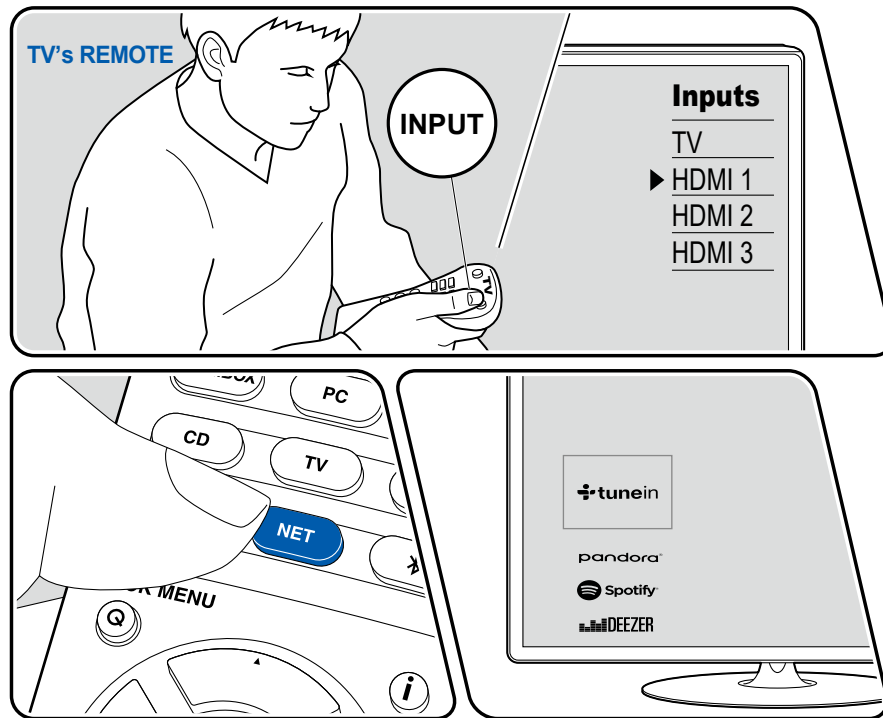



The illustration shows an image.

Perform the following procedure when this unit is on.

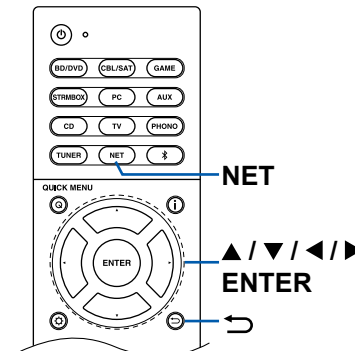
1. Switch the input on the TV to the input connected to the unit.
2. Pressing NET will display the Network Functions list screen on the TV.
3. Select your preferred Internet radio service using cursor, and press ENTER to confirm the selection.
4. Following the on-screen instructions, select a radio station and program using cursor, and then press ENTER to play.
 - To return to the previous screen, press ↶.



Internet Radio Service Menu

You can bookmark specific stations, or delete stations that have been bookmarked. The displayed menu varies according to the service being selected. The menu icon  is displayed while a station is being played. When only this icon is displayed, pressing ENTER will display the menu on the screen. When multiple icons are displayed, select the  icon with the cursor, and press ENTER.

Regarding the TuneIn Radio Account

If you create an account on the TuneIn Radio website (tunein.com), and log in it from this unit, your favorite radio stations or programs you have followed on the website are automatically added to your "My Presets" on this unit. "My Presets" is displayed on the next level in the hierarchical structure of TuneIn Radio. To display a radio station added to "My Presets", you need log into TuneIn Radio from the unit. To log in, select "Login" - "I have a TuneIn account" in the "TuneIn Radio" top list on the unit, and then enter your user name and password.

- If you select "Login" on this unit, a registration code is displayed. By using this code, you can associate the device on the My Page section of the TuneIn Radio website so that you can log in from "Login" - "Login with a registration code" without entering the user name and password.

Spotify

By connecting this unit to the same network as mobile devices, such as a smartphone and tablet, you can enjoy music played with Spotify Connect wirelessly.

- To play Spotify Connect, install a Spotify application on your smartphone or tablet. Also, you need to obtain a Spotify premium account.
 - For details of Spotify settings, go to:
www.spotify.com/connect/

Playing Back

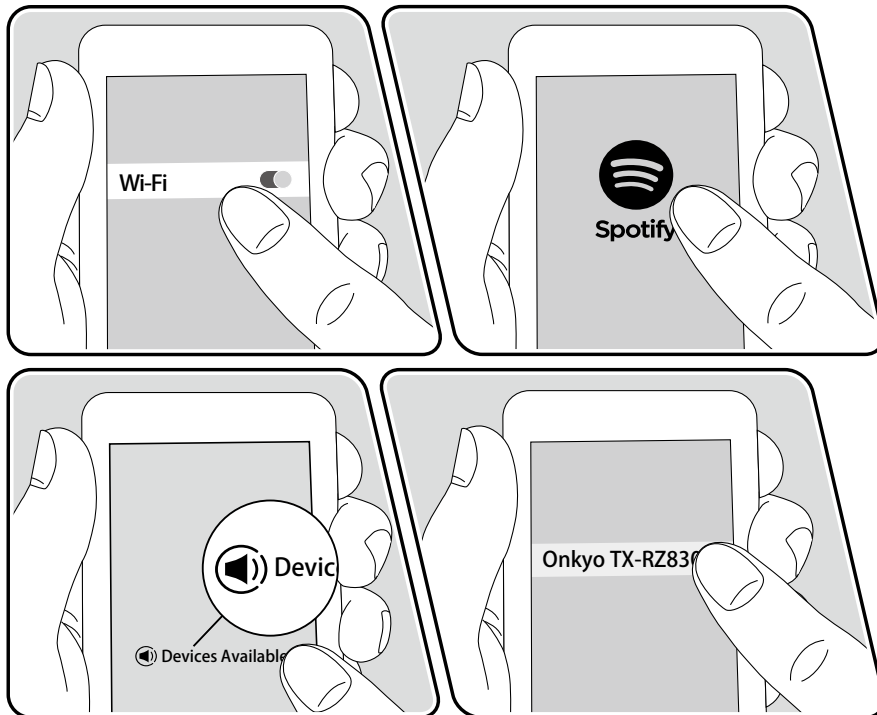

1. Connect the mobile device to the access point where this unit is connected via network.
2. Start up the Spotify application.
3. Play a track on the Spotify application, switch the screen to the playback operation screen, and then tap "Devices Available" on the bottom of the screen.
4. Select this unit.
5. This unit is automatically turned on, the input is switched to NET, and Spotify will start the streaming playback.
 - When "5. Hardware" - "Power Management" - "Network Standby" is set to "Off" in the Setup menu, turn this unit on manually, and press NET on the remote controller. In the factory default setting, the Network Standby function (→p145) is set to On.

Notes when using the multi-zone function

- To enjoy Spotify music in a separate room, select NET manually as the input of the separate room. Then, select this unit on the Spotify application.
- Volume adjustment with the Spotify application is possible for speakers connected to the ZONE speaker terminals or when the volume of the audio device in a separate room is configured so that its volume can be adjusted on this unit. In any other cases, adjust the volume on the audio device placed in a separate room.
- To enjoy Spotify music in the main room after playing it in a separate room, switch the input of the main room to NET.

AirPlay®

By connecting this unit to the same network as iOS devices, such as iPhone®, iPod touch® and iPad®, you can enjoy music files on iOS devices wirelessly.

- Update the OS version on your iOS device to the latest version.
- Depending on the iOS version, operation screens or operation procedures on the iOS device may be different. For details, refer to the operating instructions for the iOS device.

Basic Operations

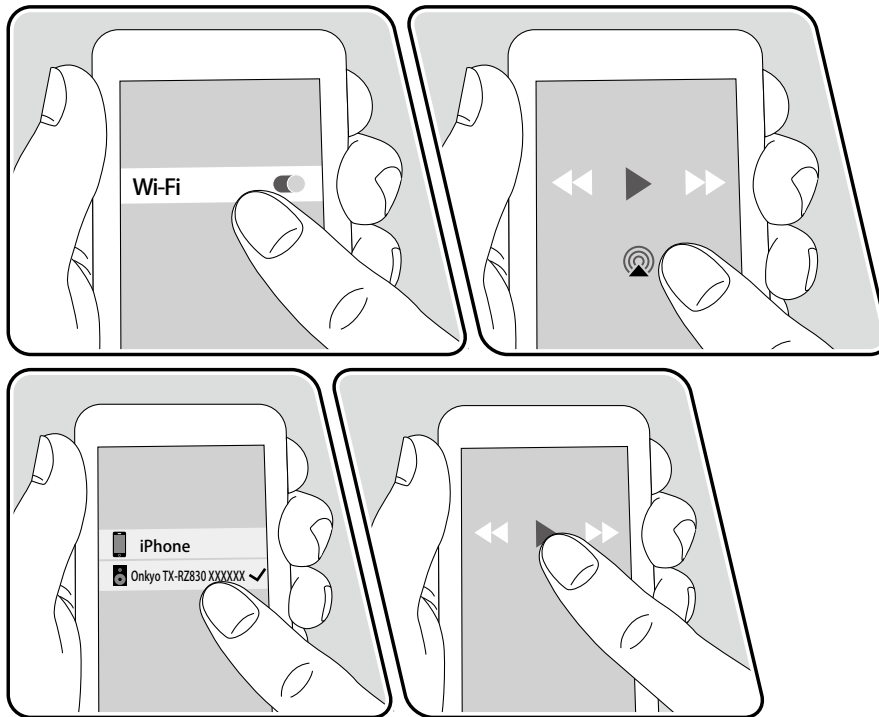

e.g., iOS 10

1. Connect the iOS device to the access point where this unit is connected via network.
2. Tap the AirPlay icon  on the play screen of the music play application on the iOS device, and select this unit from the displayed devices.
3. Play the music file on the iOS device.
 - When "5. Hardware" - "Power Management" - "Network Standby" is set to "Off" in the Setup menu, turn this unit on manually, and press NET on the remote controller. In the factory default setting, the Network Standby function ([→p145](#)) is set to On.
 - Due to the characteristics of AirPlay wireless technology, the sound produced on this unit may slightly be behind the sound played on the AirPlay-enabled device.

You can also play the music files on a PC with iTunes (Ver. 10.2 or later) equipped. Confirm that this unit and the PC are connected to the same network beforehand. Then, press NET on this unit. Next, click the AirPlay icon  in iTunes, select this unit from the displayed devices, and start play of a music file.

DTS Play-Fi®



<https://play-fi.com/>

When connecting this unit to the same network as mobile devices, such as a smartphone and tablet, you can enjoy music played on the mobile device wirelessly. Music from a streaming distribution service or music in the music library on a mobile device can be played. This function also supports a playlist on iTunes. Also, connecting multiple speakers supporting DTS Play-Fi on the same network will enable "Group playback" that plays the same music in separate rooms at home. To enjoy this function, download Onkyo Music Control App (available on iOS or Android™).



Playing Back

1. Download Onkyo Music Control App using your mobile device.
http://www.onkyo.com/playfi/app_o.html



2. Connect the mobile device to the network where this unit is connected.
 3. Starting up Onkyo Music Control App will automatically display compatible devices.
 4. Select this device from the compatible devices. Then, a list of applications such as a music streaming distribution service is displayed. Select the content to play, and perform operation according to the on-screen instructions.
- When "5. Hardware" - "Power Management" - "Network Standby" is set to "Off" in the Setup menu, turn this unit on manually, and press NET on the remote controller. In the factory default setting, the Network Standby function (→p145) is set to On.
 - For detailed operation and FAQ, visit the following URL.
http://www.onkyo.com/playfi/info_o.html
 - To use a music streaming distribution service, user registration may be required.
 - This unit does not support the following DTS Play-Fi functions.
 - Spotify
 - Wireless Surround Sound
 - Line In Rebroadcast
 - Internet Radio
 - Critical Listening
 - L/R Stereo Speaker Pairing
 - Some of the settings in the "Setup menu" cannot be changed on this unit. To change those settings, cancel the connection of this unit from the application.
 - Listening modes cannot be selected during playback.

FlareConnect™



When downloading Onkyo Controller App (available on iOS or Android™) to mobile devices, such as a smartphone and tablet, you can enjoy the group playback that plays the same music on multiple audio products supporting the FlareConnect function. You can play audio from external playback devices connected to each product, music from an Internet radio or network audio service such as a music streaming distribution service, and music in the music library on a mobile device.

Playing Back

1. Connect this unit and other devices supporting FlareConnect to the same network.
2. Download Onkyo Controller App from App Store or Google Play™ Store.
3. Connect the mobile device to the network where this unit is connected.
4. Starting up Onkyo Controller App will automatically recognize compatible devices.
5. Select the screen of the compatible device to operate, and tap the Group icon at the bottom of the screen.
6. Add a check mark for the audio product on which you want to play the same music.
7. Select the content to play, and operate according to the on-screen instructions.
 - When "5. Hardware" - "Power Management" - "Network Standby" is set to "Off" in the Setup menu, turn this unit on manually, and press NET on the remote controller. In the factory default setting, the Network Standby function (→p145) is set to On. For other devices, check their respective instruction manuals.

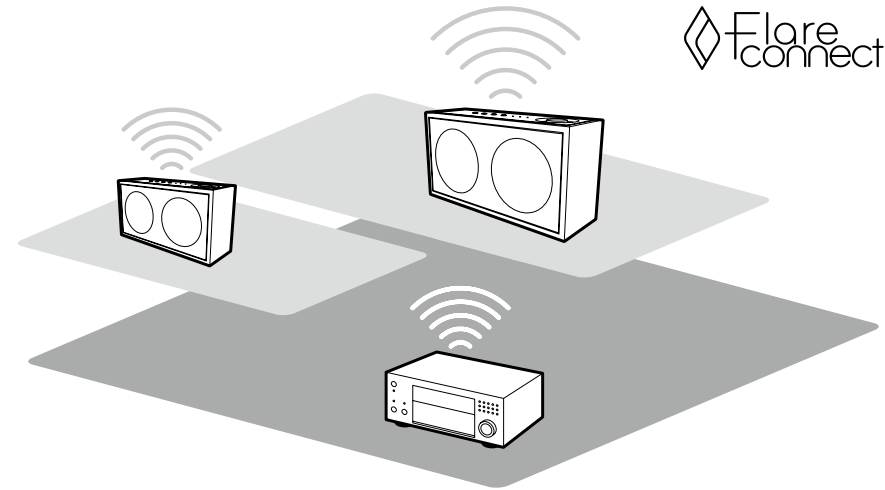

The illustration shows an image.

USB Storage Device

You can play music files stored on a USB storage device.

Basic Operations

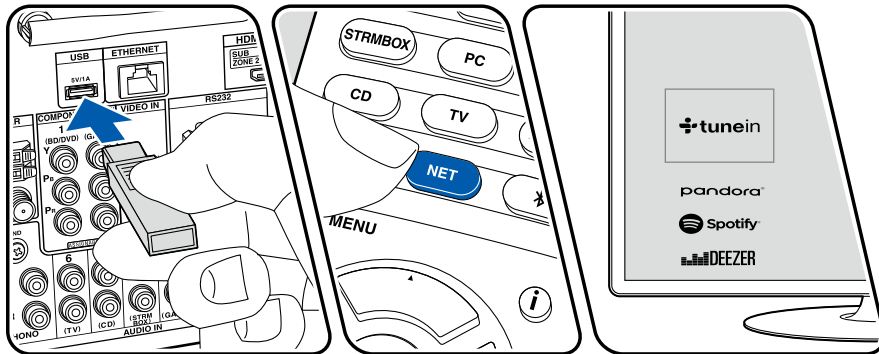
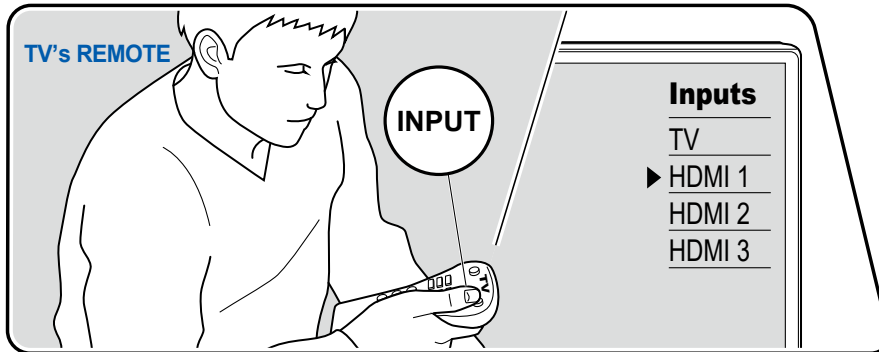

The illustration shows an image.

Perform the following procedure when this unit is on.

1. Switch the input on the TV to the input connected to the unit.
2. Plug your USB storage device containing music files into the USB port of this unit's rear panel.
3. Press NET to display the network service list screen.
4. Select "USB" with the cursors, and then press ENTER.
 - If the "USB" indicator blinks on the display, check whether the USB storage device is plugged in properly.
 - Do not unplug the USB storage device while "Connecting..." is being displayed on the display. This may cause data corruption or malfunction.
5. Press ENTER on the next screen again. The list of folders and music files on the USB storage device is displayed. Select the folder with the cursors, and press ENTER to confirm your selection.
6. Select the music file with the cursors, and then press ENTER to start playback.

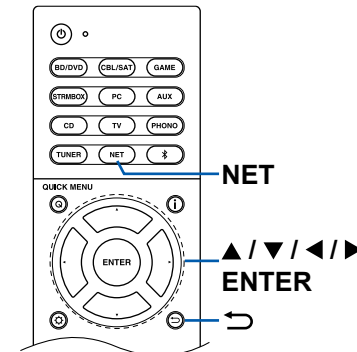

- To return to the previous screen, press ↶.
- To display an album title, artist name and album art of a file in WAV format, make the folder structure and file names as shown below when saving music files. The album art can be displayed by saving a .jpg file to display on the screen in the folder of bottom level. Note that a large volume of .jpg file may take time to be displayed, or may not be displayed.

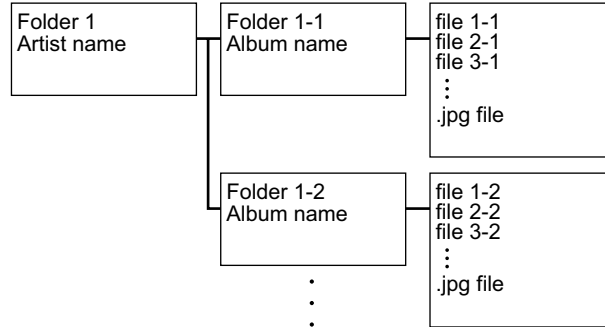

- Characters that cannot be displayed on this unit appear with "*"
- The USB port of this unit complies with the USB 2.0 standard. The transfer speed may be insufficient for some content you play, and sound interruptions, etc. may occur.
- Note that operation is not always guaranteed for all USB storage devices.
- This unit can use USB storage devices that comply with the USB mass storage class standard. Also the format of USB storage devices supports FAT16 or FAT32 file system format.

□ Device and Supported Format (→[p85](#))

Device and Supported Format

USB Storage Device Requirements

- This unit can use USB storage devices that comply with the USB mass storage class standard.
- The format of USB storage devices supports FAT16 or FAT32 file system format.
- If the USB storage device has been partitioned, each section will be treated as an independent device.
- Up to 20,000 tracks per folder are supported, and folders can be nested up to 16 levels deep.
- USB hubs and USB storage devices with hub functions are not supported. Do not connect these devices to the unit.
- USB storage devices with security functions are not supported on this unit.
- If an AC adapter is supplied with the USB storage device, connect the AC adapter, and use it with a household outlet.
- Media inserted to the USB card reader may not be available in this function. Furthermore, depending on the USB storage device, proper reading of the contents may not be possible.
- In use of a USB storage device, Onkyo accepts no responsibility whatsoever for the loss or modification of data stored on a USB storage device, or malfunction of the USB storage device. We recommend that you back up the data stored on a USB storage device before using it with this unit.

Supported Audio Formats

This unit supports the following music file formats. Note that sound files that are protected by copyright cannot be played on this unit.

MP3 (.mp3/.MP3):

- Supported formats: MPEG-1/MPEG-2 Audio Layer 3
- Supported sampling rates: 44.1 kHz, 48 kHz
- Supported bitrates: Between 8 kbps and 320 kbps, and VBR

WMA (.wma/.WMA):

- Supported sampling rates: 44.1 kHz, 48 kHz
- Supported bitrates: Between 5 kbps and 320 kbps, and VBR
- WMA Pro/Voice/WMA Lossless formats are not supported.

WAV (.wav/.WAV):

WAV files contain uncompressed PCM digital audio.

- Supported sampling rates: 44.1 kHz, 48 kHz, 88.2 kHz, 96 kHz, 176.4 kHz, 192 kHz
- Quantization bit: 8 bit, 16 bit, 24 bit

AIFF (.aiff/.aif/.AIFF/.AIF):

AIFF files contain uncompressed PCM digital audio.

- Supported sampling rates: 44.1 kHz, 48 kHz, 88.2 kHz, 96 kHz, 176.4 kHz, 192 kHz
- Quantization bit: 8 bit, 16 bit, 24 bit

AAC (.aac/.m4a/.mp4/.3gp/.3g2/.AAC/.M4A/.MP4/.3GP/.3G2):

- Supported formats: MPEG-2/MPEG-4 Audio
- Supported sampling rates: 44.1 kHz, 48 kHz, 88.2 kHz, 96 kHz
- Supported bitrates: Between 8 kbps and 320 kbps, and VBR

FLAC (.flac/.FLAC):

- Supported sampling rates: 44.1 kHz, 48 kHz, 88.2 kHz, 96 kHz, 176.4 kHz, 192 kHz
- Quantization bit: 8 bit, 16 bit, 24 bit

Apple Lossless (.m4a/.mp4/.M4A/.MP4):

- Supported sampling rates: 44.1 kHz, 48 kHz, 88.2 kHz, 96 kHz, 176.4 kHz, 192 kHz
- Quantization bit: 16 bit, 24 bit

DSD (.dsf/.dff/.DSF/.DFF):

- Supported formats: DSF/DSDIFF
- Supported sampling rates: 2.8 MHz, 5.6 MHz, 11.2 MHz

Dolby TrueHD (.vr/.mlp/.VR/.MLP):

- Supported sampling rates: 44.1 kHz, 48 kHz, 88.2 kHz, 96 kHz, 176.4 kHz, 192 kHz

- When playing files recorded with VBR (Variable bit-rate), the playback time may not be displayed correctly.
- This unit supports the gapless playback of the USB storage device in the following conditions.

When continuously playing WAV, FLAC and Apple Lossless files with the same format, sampling frequency, the number of channels and quantization bit rate.

Playing back files on a PC and NAS (Music Server)

Streaming play of music files stored on PCs or NAS devices connected to the same network as this unit is supported.

- The network servers supported by this unit are PCs that incorporate players equipped with the server functions such as Windows Media® Player 11 or 12, or NASes supporting the home network function. When using Windows Media® Player 11 or 12, you need to make the settings beforehand. Note that with PCs, only music files registered in the library of Windows Media® Player can be played.

Windows Media® Player settings

On Windows Media® Player 11

1. Turn on your PC, and start Windows Media® Player 11.
2. In the "Library" menu, select "Media Sharing" to display a dialog box.
3. Select the "Share my media" check box, and then click "OK" to display the compatible devices.
4. Select this unit, and then click "Allow".
 - When it is clicked, the corresponding icon is checked.
5. Click "OK" to close the dialog.
 - Depending on the version of Windows Media® Player, the names of items to select may differ from the above description.

On Windows Media® Player 12

1. Turn on your PC, and start Windows Media® Player 12.
2. In the "Stream" menu, select "Turn on media streaming" to display a dialog box.
 - If the media streaming is already turned on, select "More streaming options..." in the "Stream" menu to display the list of playback devices in the network, and then go to step 4.
3. Click "Turn on media streaming" to display the list of playback devices in the network.
4. Select this unit in "Media streaming options" and check that it is set to "Allow".
5. Click "OK" to close the dialog.
 - Depending on the version of Windows Media® Player, the names of items to select may differ from the above description.

□ **Playing Back** (→ [p87](#))

Playing Back

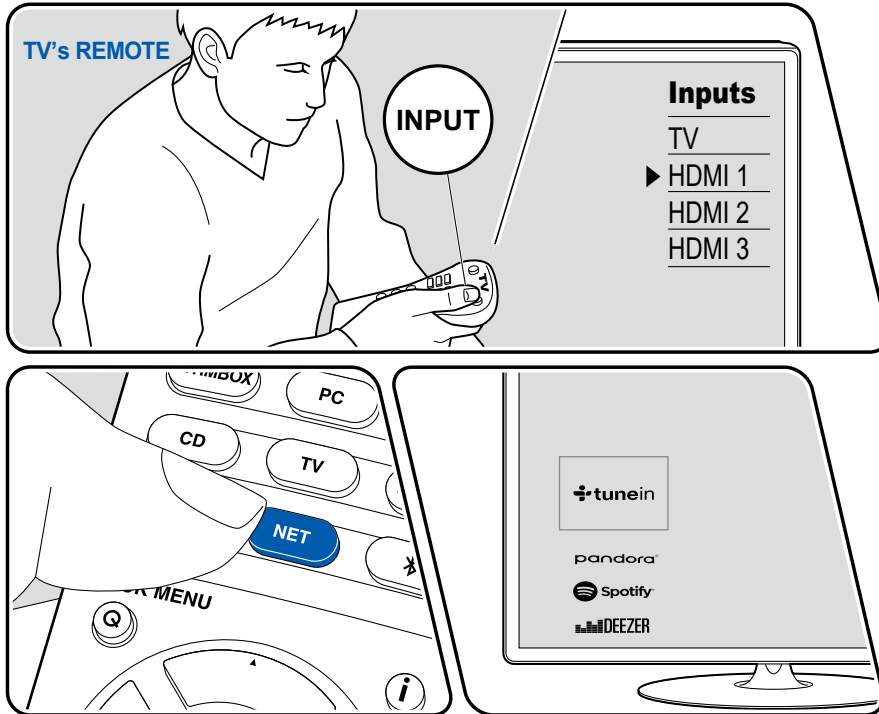

The illustration shows an image.

Perform the following procedure when this unit is on.

1. Switch the input on the TV to the input connected to the unit.
2. Start the server (Windows Media® Player 11, Windows Media® Player 12, or NAS device) containing the music files to play.
3. Make sure that the PC or NAS is properly connected to the same network as this unit.
4. Press NET to display the network service list screen.
 - If the "NET" indicator on the display blinks, the unit is not properly connected to the network. Check the connection.

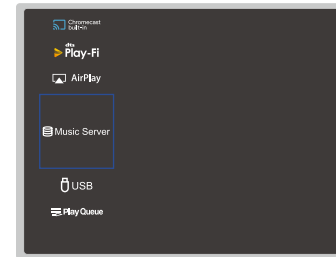

5. With the cursors, select "Music Server", and then press ENTER.

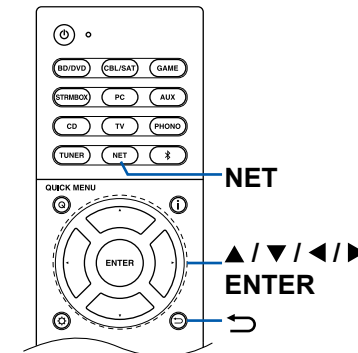

6. Select the target server with the cursors, and press ENTER to display the items list screen.
 - This unit cannot access pictures and videos stored on servers.
 - Depending on the server sharing settings, contents stored on the server may not be displayed.
7. With the cursors, select the music file to play, and then press ENTER to start playback.
 - If "No Item" is displayed on the screen, check whether the network is properly connected.
 - To return to the previous screen, press ↩.
 - For music files on a server, up to 20,000 tracks per folder are supported, and folders can be nested up to 16 levels deep.
 - Depending on the type of media server, the unit may not recognize it, or may not be able to play its music files.

Searching music files to select

If the server you use supports search functions, the following search function can be used.

Perform the following procedure with available servers displayed using Music Server.

1. With ▲ / ▼, select the server containing music files you want to play, and select ENTER.
2. With ▲ / ▼, select the Search folder, and press ENTER. The Search folder contains the following three folders.
 - "Search by Artist": Select this when searching by artist name.
 - "Search by Album": Select this when searching by album title.
 - "Search by Track": Select this when searching by track title.
3. With ▲ / ▼, select the folder, and press ENTER.
4. Input a character string to search for, and press ENTER. Then, the search result is displayed.
5. With ▲ / ▼, select the music files to play, and select ENTER.

Controlling Remote Playback from a PC

You can use this unit to play music files stored on your PC by operating the PC in your home network. The unit supports remote playback via Windows Media® Player 12. To use the remote playback function of this unit with Windows Media®

Player 12, it must be configured beforehand.

Setting PC

1. Turn on your PC, and start Windows Media® Player 12.
2. In the "Stream" menu, select "Turn on media streaming" to display a dialog box.
 - If the media streaming is already turned on, select "More streaming options..." in the "Stream" menu to display the list of playback devices in the network, and then go to step 4.
3. Click "Turn on media streaming" to display the list of playback devices in the network.
4. Select this unit in "Media streaming options" and check that it is set to "Allow".
5. Click "OK" to close the dialog box.
6. Open the "Stream" menu and confirm that "Allow remote control of my Player..." is checked.
 - Depending on the version of Windows Media® Player, the names of items to select may differ from the above description.

Remote playback

1. Turn on the power of the unit.
2. Turn on your PC, and start Windows Media® Player 12.
3. Select and right-click the music file to play with Windows Media® Player 12.
 - To remotely play a music file on another server, open the target server from "Other Libraries", and select the music file to play.
4. Select this unit in "Play to" to open the "Play to" window of Windows Media® Player 12, and start playback on this unit.
 - If your PC is running on Windows® 8.1, click "Play to", and select this unit. If your PC is running on Windows® 10, click "Cast to Device", and select this unit. Operations during remote playback are possible from the "Play to" window on the PC. The playback screen is displayed on the HDMI-connected TV.
5. Adjust the volume using the volume bar on the "Play to" window.
 - Sometimes, the volume displayed on the remote playback window may differ from the volume displayed on the display of this unit.
 - When the volume is changed on this unit, the value is not reflected in the "Play to" window.
 - This unit cannot play music files remotely in the following conditions.
 - It is using a network service.

- It is playing a music file on a USB storage device.
- Depending on the version of Windows Media® Player, the names of items to select may differ from the above description.

□ Supported Audio Formats (→[p90](#))

Supported Audio Formats

This unit supports the following music file formats. Remote play of FLAC and DSD is not supported.

MP3 (.mp3/.MP3):

- Supported formats: MPEG-1/MPEG-2 Audio Layer 3
- Supported sampling rates: 44.1 kHz, 48 kHz
- Supported bitrates: Between 8 kbps and 320 kbps, and VBR

WMA (.wma/.WMA):

- Supported sampling rates: 44.1 kHz, 48 kHz
- Supported bitrates: Between 5 kbps and 320 kbps, and VBR
- WMA Pro/Voice/WMA Lossless formats are not supported.

WAV (.wav/.WAV):

WAV files contain uncompressed PCM digital audio.

- Supported sampling rates: 44.1 kHz, 48 kHz, 88.2 kHz, 96 kHz, 176.4 kHz, 192 kHz
- Quantization bit: 8 bit, 16 bit, 24 bit

AIFF (.aiff/.aif/.AIFF/.AIF):

AIFF files contain uncompressed PCM digital audio.

- Supported sampling rates: 44.1 kHz, 48 kHz, 88.2 kHz, 96 kHz, 176.4 kHz, 192 kHz
- Quantization bit: 8 bit, 16 bit, 24 bit

AAC (.aac/.m4a/.mp4/.3gp/.3g2/.AAC/.M4A/.MP4/.3GP/.3G2):

- Supported formats: MPEG-2/MPEG-4 Audio
- Supported sampling rates: 44.1 kHz, 48 kHz, 88.2 kHz, 96 kHz
- Supported bitrates: Between 8 kbps and 320 kbps, and VBR

FLAC (.flac/.FLAC):

- Supported sampling rates: 44.1 kHz, 48 kHz, 88.2 kHz, 96 kHz, 176.4 kHz, 192 kHz
- Quantization bit: 8 bit, 16 bit, 24 bit

LPCM (Linear PCM):

- Supported sampling rates: 44.1 kHz, 48 kHz
- Quantization bit: 16 bit

Apple Lossless (.m4a/.mp4/.M4A/.MP4):

- Supported sampling rates: 44.1 kHz, 48 kHz, 88.2 kHz, 96 kHz
- Quantization bit: 16 bit, 24 bit

DSD (.dsf/.dff/.DSF/.DFF):

- Supported formats: DSF/DSDIFF
- Supported sampling rates: 2.8 MHz, 5.6 MHz, 11.2 MHz
- When playing files recorded with VBR (Variable bit-rate), the playback time may not be displayed correctly.
- Remote playback does not support the gapless playback.

Play Queue



When downloading Onkyo Controller App (available on iOS or Android™) to mobile devices, such as a smartphone and tablet, you can save your favorite playlist (Play Queue information) among music files stored in the USB storage device connected to this unit and music files stored in PC or NAS connected to the same network as this unit, and you can play the music on the playlist. The Play Queue information is effective until the power cord of this unit is removed from the outlet.

Initial Setup

1. Connect this unit to your home network by the network settings on this unit.
2. Download Onkyo Controller App from App Store or Google Play™ Store.
3. Connect the mobile device to the network where this unit is connected.
4. Start up Onkyo Controller App, and select this unit.

Adding Play Queue Information

1. Select the "INPUT" input on the application screen, and tap the "USB" icon. Or, select the "NET" input, and tap the "USB" icon or "Music Server" icon. (Depending on the model, the icon names may be different.)

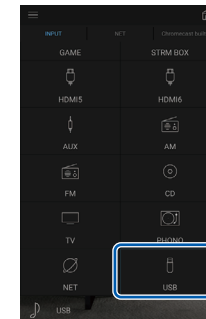

2. Tapping the "+" icon of the track you want to add will open the pop-up to add the Play Queue information.

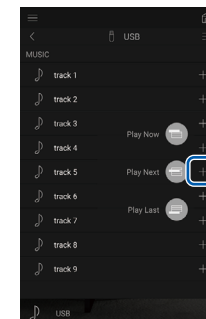

3. Touch the "Play Now" (⏮), "Play Next" (⏭) or "Play Last" (⏪) icon to add the track to Play Queue.

- If there are no tracks on the Play Queue list, only "Play Now 

Sort and Delete

1. Select the "NET" input, tap the "Play Queue" icon, and enter the Play Queue service screen.

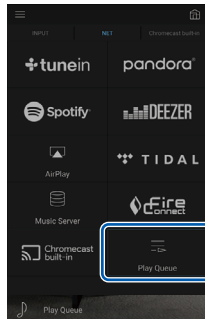

2. Tap the "≡" icon of the track to sort, and drag the icon to the destination.

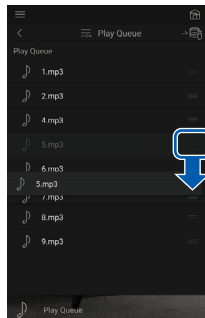

3. To delete a track, slide the track to the left until the trash icon changes to . If the device is on iOS, slide the "≡" icon to the left. Releasing your finger will delete the track from Play Queue.

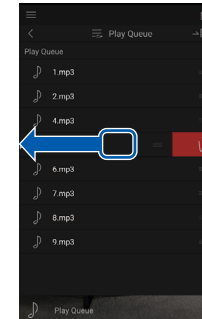

Playing Back

Playback starts when you select "Play Now 

Listening To the AM/FM Radio

You can receive AM and FM radio stations on this unit with the built-in tuner.

Tuning into a Radio Station

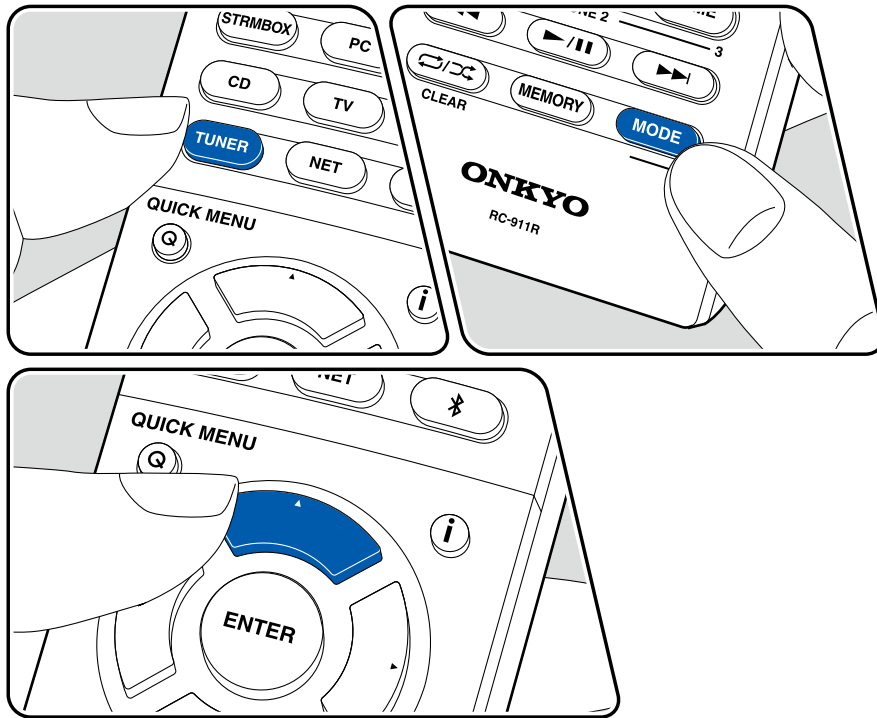

Perform the following procedure when this unit is on.

Tuning Automatically

1. Press TUNER repeatedly to select either "AM" or "FM".
2. Press MODE to display "TunMode: Auto" on the display.

TunMode: Auto

3. When you press the cursors ▲ / ▼, automatic tuning starts, and searching stops when a station is found. When tuned in to a radio station, the "TUNED" indicator on the display lights up. When tuned in to an FM radio station, the "FM ST" indicator lights up.

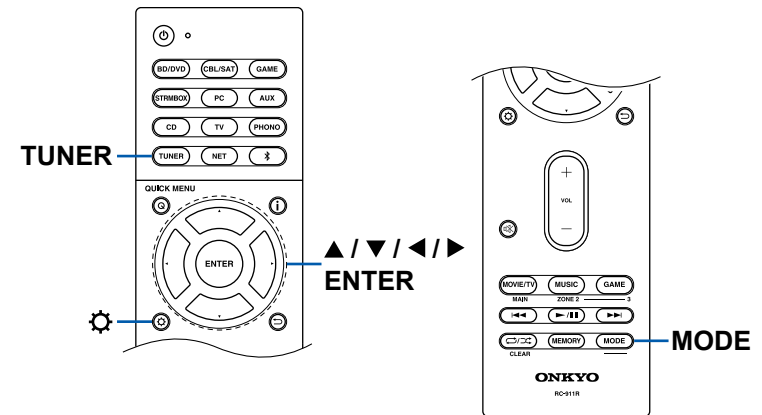

When FM broadcasts reception is poor: Perform the procedure for "Tuning Manually" (→p94). Note that if you tune manually, the reception for FM broadcasts will be monaural rather than stereo, irrespective of the sensitivity of the reception.

Tuning Manually

Note that if you tune manually, the reception for FM broadcasts will be monaural rather than stereo, irrespective of the sensitivity of the reception.

1. Press TUNER repeatedly to select either "AM" or "FM".
2. Press MODE to display "TunMode: Manual" on the display.

TunMode: Manual

3. While pressing the cursors ▲ / ▼, select the desired radio station.
 - Each time you press the cursors ▲ / ▼, the frequency changes by 1 step. If the button is held down, the frequency changes continuously, and if the button is released, the frequency stops changing.

Frequency step setting

Press ⚙, and using the cursors and ENTER, select "7. Miscellaneous" - "Tuner" - "AM/FM Frequency Step" or "AM Frequency Step", and then select the frequency step for your area. Note that when this setting is changed, all radio presets are deleted.

❑ Presetting a Radio Station (→p95)

Presetting a Radio Station

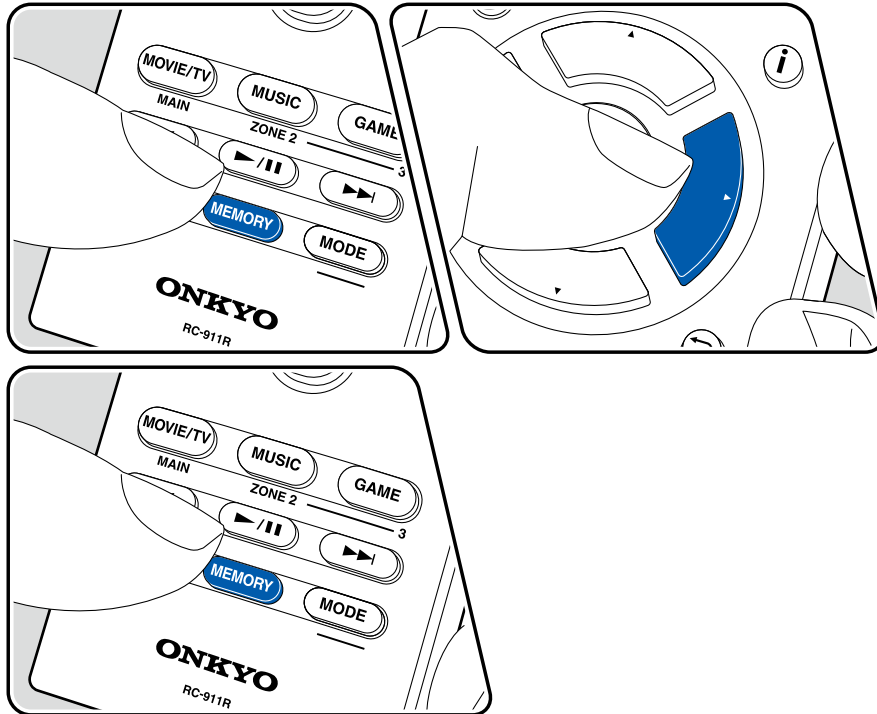

Registration Procedure

You can preset up to 40 of your favorite AM/FM radio stations.

After tuning in to the AM/FM radio station you want to register, perform the following procedure.

1. Press MEMORY so that the preset number on the display blinks.

FM 87.5 MHz

2. While the preset number is blinking (approx. 8 seconds), repeatedly press the cursors ◀/▶ to select a number between 1 and 40.
3. Press MEMORY again to register the station.

When the station is registered, the preset number stops blinking. Repeat this steps to register your favorite AM/FM radio stations.

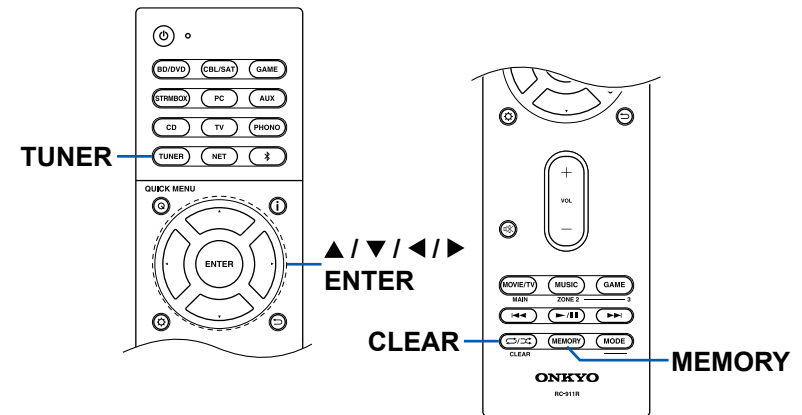

Selecting a Preset Radio Station

1. Press TUNER.
2. Press the cursors ◀/▶ to select a preset number.

Deleting a Preset Radio Station

1. Press TUNER.
2. Press the cursors ◀/▶ to select the preset number to delete.
3. After pressing MEMORY, press CLEAR while the preset number is blinking, and delete the preset number. When deleted, the number on the display disappears.

❑ **Using RDS (European, Australian and Asian models)** (→[p97](#))

Using RDS (European, Australian and Asian models)

RDS stands for Radio Data System, and is a method of transmitting data in FM radio signals. In regions where RDS can be used, when you tune in to a radio station broadcasting program information, the radio station name is displayed on the display. When you press **i** on the remote controller in this state, you can use the following functions.

Display Text Information (Radio Text)

1. While the name of the station is being displayed on the display, press **i** on the remote controller once.
The Radio Text (RT), which is text information delivered by the station, is displayed scrolling across the display. "No Text Data" is displayed when no text information is delivered.

characters. This is not a malfunction. Also, if the signal from a station is weak, information may not be displayed.

Search for Stations by Program Type

1. While the name of the station is being displayed on the display, press **i** on the remote controller twice.
2. Press the cursors **◀/▶** on the remote controller to select the Program Type you want to search for, and then press the ENTER button to start the search.
 - The Program Types displayed are as follows: None / News (News reports) / Affairs (Current affairs) / Info (Information) / Sport / Educate (Education) / Drama / Culture / Science (Science and technology) / Varied / Pop M (Pop music) / Rock M (Rock music) / Easy M (Middle of the road music) / Light M (Light classics) / Classics (Serious classics) / Other M (Other music) / Weather / Finance / Children (Children's programmes) / Social (Social affairs) / Religion / Phone In / Travel / Leisure / Jazz (Jazz music) / Country (Country music) / Nation M (National music) / Oldies (Oldies music) / Folk M (Folk music) / Document (Documentary)
 - The information displayed may not match the content delivered by the station.
3. When a station is found, the station blinks on the display. Pressing the ENTER button in this state will receive that station. If you don't press the ENTER button, the unit starts to search for another station.
 - If no stations are found, the message "Not Found" is displayed.
 - Unusual characters may be displayed when the unit receives unsupported

Multi-zone

You can enjoy 2-ch audio in the separate room (ZONE 2/ZONE 3) while performing playback in the main room (where this unit is located). The same source can be played back in the main room and ZONE 2/ZONE 3 simultaneously. Also, different sources can be played back in both rooms. For the "NET" or "BLUETOOTH" input selector, you can select only the same source for the main room and separate room. If you select "NET" in the main room and then select "BLUETOOTH" in the separate room, the main room setting switches to "BLUETOOTH". You cannot select different stations of AM/FM broadcasts for the main room and separate room. Onkyo Controller App is useful for the multi-zone playback operation. Download Onkyo Controller App (available on iOS or Android™) to a mobile device, such as a smartphone and tablet to use it.



□ **Switch remote control mode (→[p99](#))**

Switch remote control mode (ZONE 2)

Setting the ZONE control mode (ZONE 2)

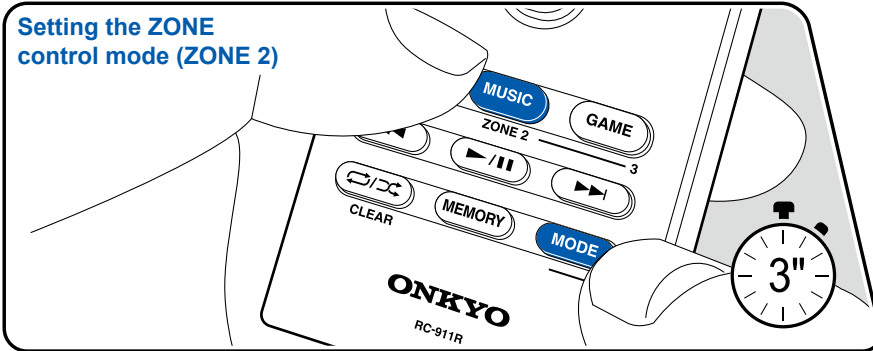

Setting the main room control mode

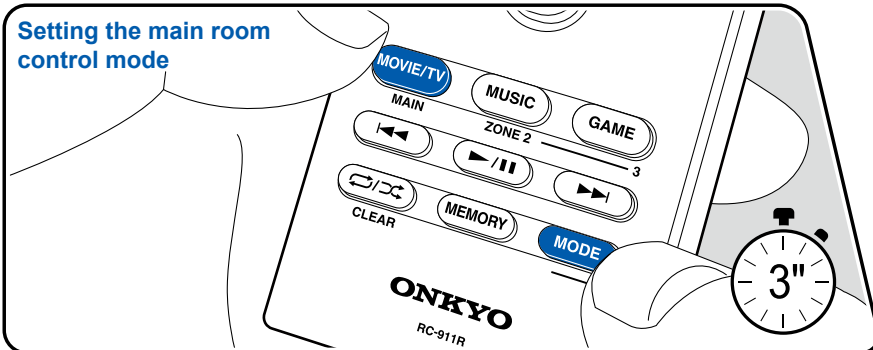

At the time of purchase, the remote controller is in the mode to control playback in the main room. To play a source in ZONE 2, set the remote controller to the ZONE control mode (ZONE 2). To control the main room play again, restore the remote controller to the main room control mode.

1. While pressing and holding MODE, press ZONE 2 at least 3 seconds until the remote indicator blinks twice.
 - The mode of the remote controller switches to the mode to control ZONE 2.
 - To restore the main room control mode, while pressing and holding MODE, press MAIN at least 3 seconds until the remote indicator blinks once.

Setting the ZONE control mode (ZONE 2)

Setting the main room control mode

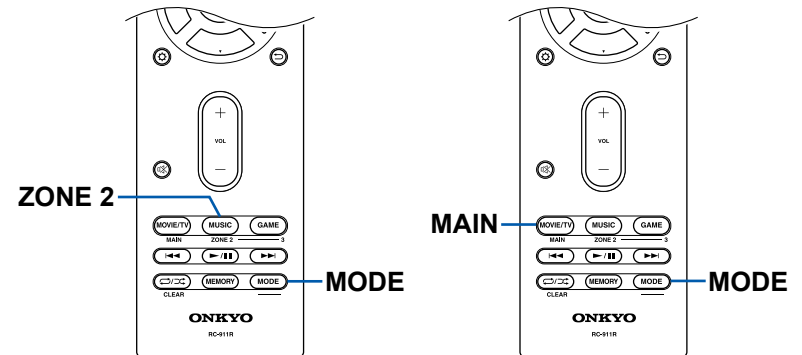

Switch remote control mode (ZONE 3)

Setting the ZONE control mode (ZONE 3)

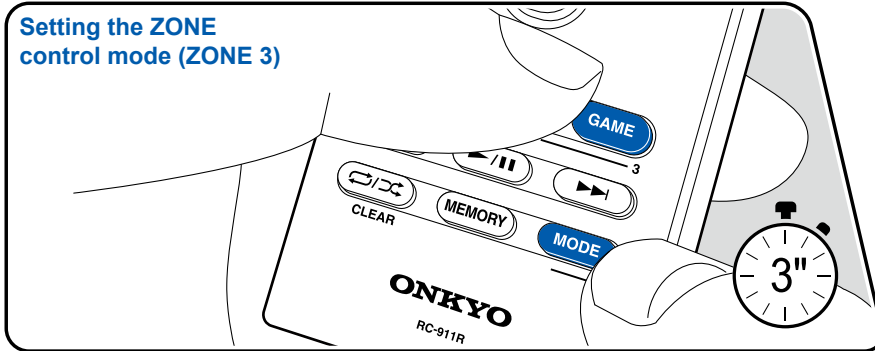

Setting the main room control mode

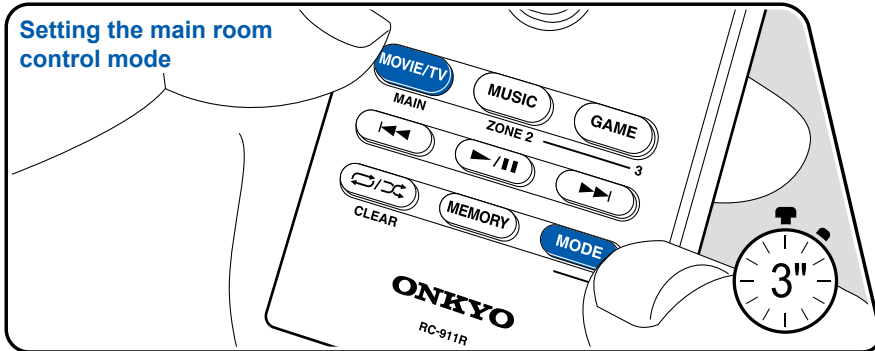

At the time of purchase, the remote controller is in the mode to control playback in the main room. Settings are required to playback a source in ZONE 3.

When outputting from the speakers: Set "2. Speaker" - "Configuration" - "Zone Speaker" in the Setup menu (→p132) to "Zone 2/Zone 3", and set the remote controller to ZONE control mode (ZONE 3). To operate the playback of the main room again, it is necessary to return the remote controller to the main room control mode.

When outputting from the integrated amplifier or the power amplifier: Set "2. Speaker" - "Configuration" in the Setup (→p132) to one of the following, and set the remote controller to ZONE control mode (ZONE 3). To operate the playback of the main room again, it is necessary to return the remote controller to the main room control mode.

- Set "Speaker Channels" to "2.1 ch", "3.1 ch", "4.1 ch", or "5.1 ch"
 - Set "Speaker Channels" to "2.1.2 ch", "3.1.2 ch", "4.1.2 ch", or "5.1.2 ch", and set "Bi-Amp" and "Zone Speaker" to "No"
1. While pressing and holding MODE, press ZONE 3 at least 3 seconds until the remote indicator blinks three times.
 - The mode of the remote controller switches to the mode to control ZONE 3.
 - To restore the main room control mode, while pressing and holding MODE, press MAIN at least 3 seconds until the remote indicator blinks once.

Setting the ZONE control mode (ZONE 3)

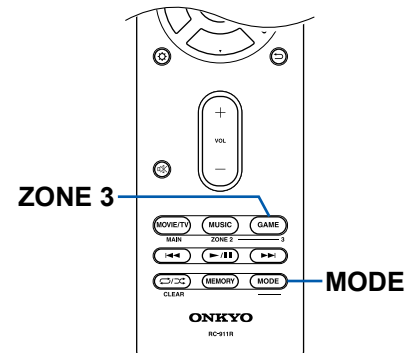

Setting the main room control mode

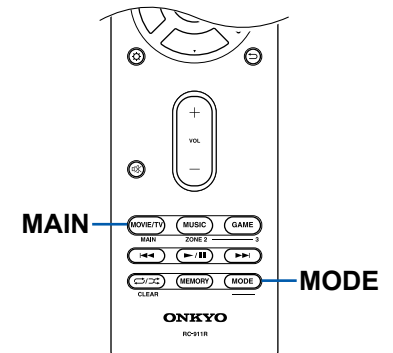

Playing Back

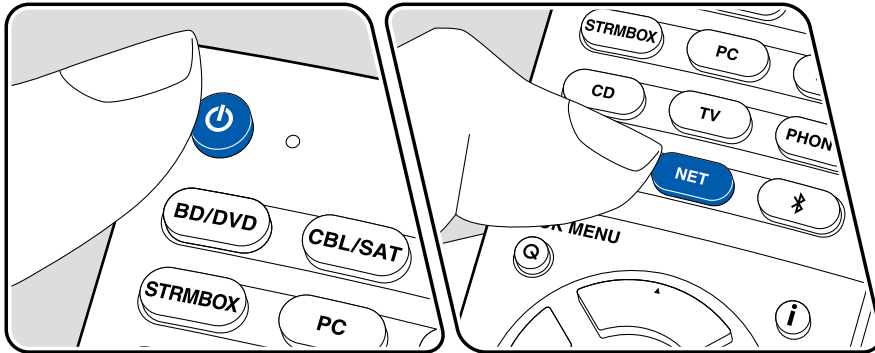

Set the remote controller to the ZONE control mode (ZONE 2/ZONE 3) (→p99, 100), and then perform the following operations.

1. Point the remote controller at the unit, and press \odot .
 - "Z2" or "Z3" on the display of the main unit lights up.
 - ZONE 3 cannot be turned ON unless "2. Speaker" - "Configuration" - "Zone Speaker" in the Setup menu (→p132) is not set to "Zone 2/Zone 3".

Z2 Z3

2. Press the input selector of the input source you want to play in the separate room. To control on the main unit, press ZONE 2 button or ZONE 3 button, and then within 8 seconds, press the input selector button of the input to be played in the separate room. To play the same source in the main room and separate room, press ZONE 2 button or ZONE 3 button of the main unit twice.
3. If the unit is connected to the pre-main amplifier in the separate room, adjust the volume on the pre-main amplifier. If the unit is connected to the power amplifier or ZONE speaker in the separate room, adjust the volume on the remote controller. To do this on the main unit, press ZONE 2 button or ZONE 3 button, and then within 8 seconds, adjust the volume using the MASTER VOLUME dial.
 - When adjusting the volume of the power amplifier placed in the separate room by using this unit, set "6. Multi Zone" - "Zone 2" (or "Zone 3") - "Output Level" (→p146) to "Variable" on the Setup menu.
 - The sound quality of the power amplifier connected in the separate room can also be adjusted. Press the ZONE 2 button of this unit, and then press the TONE button within 8 seconds. Then turn the TONE dial for adjustment.
 - Information of a connected device can be displayed on the TV in the separate room. Set the remote controller to the ZONE control mode (ZONE 2), and then press \mathbf{i} .
- If you turn the unit to standby during multi-zone playback, the Z2 or Z3 indicator is dimmed, and the playback mode is switched to playback in a separate room only. Setting ZONE 2/ZONE 3 to on while the unit is in standby also switches the playback mode to playback in a separate room only.
- For ZONE 2 output, audio from externally connected AV components can

be output only when it is an analog or 2ch PCM audio signal. When the AV component is connected to this unit with an HDMI cable, digital coaxial cable or digital optical cable, change the audio output of the AV component to the PCM output.

- When video and audio via HDMI input are output to ZONE 2, set "1. Input/ Output Assign" - "TV Out / OSD" - "Zone2 HDMI" (→[p128](#)) to "Use" on the Setup menu.
- For ZONE 3 output, audio from externally connected AV components can be output only when it is an analog audio signal.
- DSD and Dolby TrueHD audio signals cannot be output to ZONE 2/ZONE 3 when selected with the "NET" input selector.
- If ZONE 2/ZONE 3 is on, power consumption during standby will increase.
- If ZONE 2 is turned on when the Pure Audio listening mode is selected in the main room , the mode will automatically switch to the Direct listening mode.

To set the function to off: Press \odot while the remote controller is in the ZONE control mode.

WHOLE HOUSE MODE: When the WHOLE HOUSE MODE button of the main unit is pressed during playback in the main room, "Z2" and "Z3" on the display light up at the same time, and the WHOLE HOUSE MODE function is turned on with which the same source is played back at once in all rooms.

- Sources that can be played in ZONE 2 can be played in all rooms.
- This function cannot be used if headphones are connected or audio is output from the speakers of the TV.
- Depending on the setting of "2. Speaker" - "Configuration" in the Setup menu (→[p132](#)), it may not be able to output to ZONE 3.

Convenience functions

Adjusting the tone

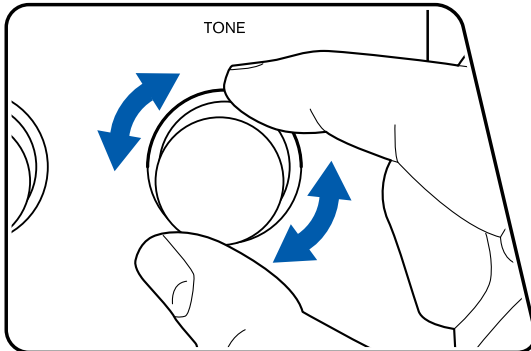
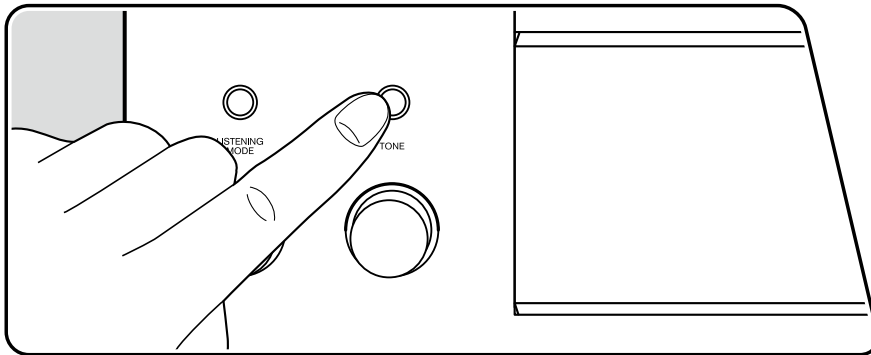

You can adjust the sound quality of the speakers.

1. Press the TONE button on the main unit to select the setting to adjust from "Bass" and "Treble".
 Bass: Enhances or moderates the low-tone range of the speakers.
 Treble: Enhances or moderates the high-tone range of the speakers.
2. Turn the TONE dial for adjustment.

The tone can be adjusted on the quick menu using the remote controller. ([→p148](#))

Sleep Timer

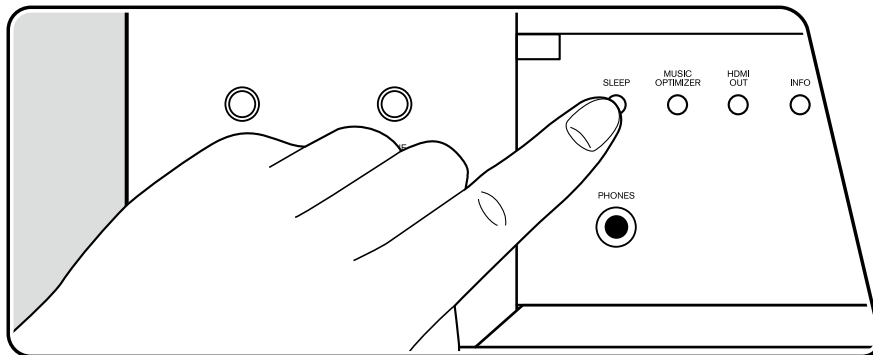

You can allow the unit to enter standby automatically when the specified time has elapsed.

Select the time from "30 min", "60 min" and "90 min".

"Off": The unit does not automatically enter standby mode.

Press  button on the remote controller to set on the Setup menu. (→[p144](#))

Listening Mode

This unit is equipped with a variety of listening modes, and you can select the optimum listening mode for movies, TV, music, and games by pressing MOVIE/TV, MUSIC, and GAME.

Selecting a Listening mode

1. Press one from among MOVIE/TV, MUSIC, and GAME during playback.
2. Press the selected button repeatedly to switch the modes displayed on the display of the main unit.

DTS

- Each of MOVIE/TV, MUSIC and GAME buttons stores the listening mode that was selected last. If content incompatible of the listening mode selected last is played, the most standard listening mode for the content is automatically selected.
- For details of the effects of each listening mode, refer to "Listening Mode Effects" (→[p107](#)).
- For listening modes selectable for each audio format of input signals, refer to "Selectable Listening Modes" (→[p112](#)).

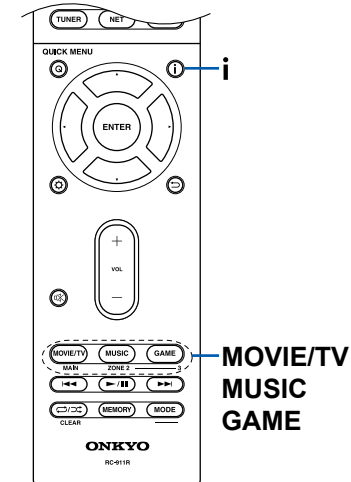

Checking the input format and listening mode

Pressing **i** repeatedly will switch the display of the main unit in the following order.

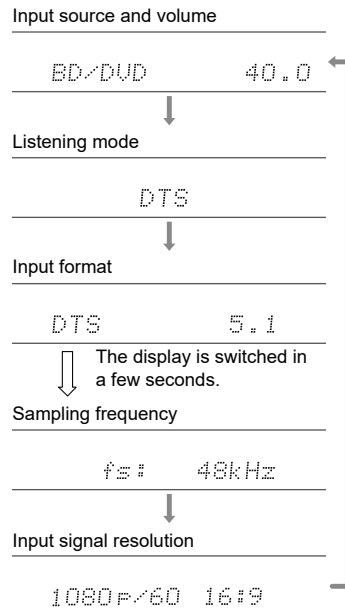

Listening Mode Effects

In alphabetical order

■ AllCh Stereo

This mode is ideal for background music. Stereo sound is played through the surround speakers as well as the front speakers, creating a stereo image.

■ Direct

This listening mode can be selected for all input signals. Processing that affects sound quality is shut down, and sound closer to the original is reproduced. The sound is reproduced with the sound field based on the number of channels in the input signal. For example, a 2ch signal is output only from the front speakers. Note that the sound adjustment is not available when this mode is selected.

■ Dolby Atmos

This mode faithfully reproduces the sound design recorded in the Dolby Atmos audio format.

The Dolby Atmos audio format has been implemented in movie theaters equipped with the latest facilities, and enables a revolutionary sound experience in home theaters. Unlike existing surround systems, Dolby Atmos doesn't rely on channels, but rather enables the accurate placement of sound objects that have independent motion in a three-dimensional space with even greater clarity. Dolby Atmos is an optional audio format for Blu-ray Discs and achieves a more three-dimensional sound field by introducing a sound field above the listener.

- To enable transfer of this audio format, connect via an HDMI cable and set audio output on the player to Bitstream output.

■ DD (Dolby Audio - DD)

This mode faithfully reproduces the sound design recorded in the Dolby Digital audio format.

Dolby Digital is a multi-channel digital format developed by Dolby Laboratories, Inc. and is widely adopted for use in movie production. It is also a standard audio format for DVD-Video and Blu-ray Discs. It is possible to record a maximum of 5.1 channels on a DVD-Video or Blu-ray Disc; two front channels, one center channel, two surround channels, and the LFE channel dedicated to the bass

region (sound elements for the subwoofer).

- To enable transfer of this audio format, connect via a digital cable and set audio output on the player to Bitstream output.

■ DD+ (Dolby Audio - DD+)

This mode faithfully reproduces the sound design recorded in the Dolby Digital Plus audio format.

The Dolby Digital Plus format has been improved based on Dolby Digital, increasing the number of channels and endeavoring to improve sound quality by giving more flexibility in data bit rates. Dolby Digital Plus is an optional audio format based on 5.1ch for Blu-ray Discs. It is possible to record a maximum of 7.1 channels with additional channels such as the surround back channel.

- To enable transfer of this audio format, connect via an HDMI cable and set audio output on the player to Bitstream output.

■ DSur (Dolby Audio - DSur)

This listening mode expands actual channels to more channels for playback to suit the configuration of the connected speakers by expanding the input signals from 2 channels or 5.1 channels to 5.1 channels or 7.1 channels respectively. As well as traditional speaker setups, this supports ceiling-embedded speakers and playback systems for Dolby Atmos that adopt the Dolby speaker technology.

■ DTHD (Dolby Audio - TrueHD)

This mode faithfully reproduces the sound design recorded in the Dolby TrueHD audio format.

The Dolby TrueHD audio format is a "lossless" format expanded based on the lossless compression technology referred to as MLP, and it faithfully reproduces the master audio recorded in the studio. Dolby TrueHD is an optional audio format based on 5.1ch for Blu-ray Discs. It is possible to record a maximum of 7.1 channels with additional channels such as the surround back channel. 7.1ch is recorded at 96 kHz/24 bit, and 5.1ch is recorded at 192 kHz/24 bit.

- To enable transfer of this audio format, connect via an HDMI cable and set audio output on the player to Bitstream output.

■ DSD

This mode is suitable for playing sources recorded in DSD.

- This unit supports the DSD signal input from the HDMI input terminal. However, depending on the connected player, better sound may be obtained by setting the output on the player side to the PCM output.
- This listening mode cannot be selected if the output setting on your Blu-ray Disc/DVD player is not set to DSD.

■ DTS

This mode faithfully reproduces the sound design recorded in the DTS audio format.

The DTS audio format is a multi-channel digital format developed by DTS, Inc. This format is an optional audio format for DVD-Video and a standard format for Blu-ray Discs. It enables recording of 5.1 channels; two front channels, one center channel, two surround channels, and the LFE channel dedicated to the bass region (sound elements for the subwoofer). The content is recorded with a rich volume of data, with a maximum sampling rate of 48 kHz, at a resolution of 24 bits and a bit rate of 1.5 Mbps.

- To enable transfer of this audio format, connect via a digital cable and set audio output on the player to Bitstream output.

■ DTS 96/24

This mode faithfully reproduces the sound design recorded in the DTS 96/24 audio format.

The DTS 96/24 format is an optional audio format for DVD-Video and Blu-ray Discs. It enables recording of 5.1 channels; two front channels, one center channel, two surround channels, and the LFE channel dedicated to the bass region (sound elements for the subwoofer). Detailed reproduction is achieved by recording the content at a sampling rate of 96 kHz and at a resolution of 24 bits.

- To enable transfer of this audio format, connect via a digital cable and set audio output on the player to Bitstream output.

■ DTS Express

This mode faithfully reproduces the sound design recorded in the DTS Express audio format.

DTS Express is an optional audio format based on 5.1ch for Blu-ray Discs. It is

possible to record a maximum of 7.1 channels with additional channels such as the surround back channel. It also supports low bit rates.

- To enable transfer of this audio format, connect via an HDMI cable and set audio output on the player to Bitstream output.

■ DTS-HD HR (DTS-HD High Resolution Audio)

This mode faithfully reproduces the sound design recorded in the DTS-HD High Resolution Audio audio format.

DTS-HD High Resolution Audio is an optional audio format based on 5.1ch for Blu-ray Discs. It is possible to record a maximum of 7.1 channels with additional channels such as the surround back channel at a sampling rate of 96 kHz and at a resolution of 24 bits.

- To enable transfer of this audio format, connect via an HDMI cable and set audio output on the player to Bitstream output.

■ DTS-HD MSTR (DTS-HD Master Audio)

This mode faithfully reproduces the sound design recorded in the DTS-HD Master Audio audio format.

DTS-HD Master Audio is an optional audio format based on 5.1ch for Blu-ray Discs. It is possible to record a maximum of 7.1 channels with additional channels such as the surround back channel using the lossless audio reproduction technology. 96 kHz/24 bit is supported for 7.1ch, and 192 kHz/24 bit is supported for 5.1ch.

- To enable transfer of this audio format, connect via an HDMI cable and set audio output on the player to Bitstream output.

■ DTS Neural:X

This listening mode expands actual channels to more channels for playback to suit the configuration of the connected speakers by expanding the input signals from 2 channels or 5.1 channels to 5.1 channels or 7.1 channels respectively.

■ DTS:X

This mode faithfully reproduces the sound design recorded in the DTS:X audio format.

The DTS:X audio format is a combination of the mixing method based on traditional channel based formats (5.1ch and 7.1ch) and object based dynamic

audio mixing, and it is characterized by the precise positioning of sounds and the ability to express sound movement.

- To enable transfer of this audio format, connect via an HDMI cable and set audio output on the player to Bitstream output.

■ ES Discrete (DTS-ES Discrete)

This mode faithfully reproduces the sound design recorded in the DTS-ES Discrete audio format.

DTS-ES Discrete is an optional audio format based on 5.1ch for DVD-Video and Blu-ray Discs. It is possible to record a maximum of 6.1 channels with a monaural surround back channel added.

- To enable transfer of this audio format, connect via a digital cable and set audio output on the player to Bitstream output.

■ ES Matrix (DTS-ES Matrix)

This mode faithfully reproduces the sound design recorded in the DTS-ES Matrix audio format.

DTS-ES Matrix is an optional audio format based on 5.1ch for DVD-Video and Blu-ray Discs. A monaural surround back channel is inserted to this format by matrix encoding. During playback, 6.1 channel-playback is achieved by the matrix decoder on this unit.

- To enable transfer of this audio format, connect via a digital cable and set audio output on the player to Bitstream output.

■ Full Mono

In this mode, all speakers output the same sound in mono, so the sound you hear is the same regardless of where you are within the listening room.

■ Game-Action

This mode is suitable for games with a lot of action.

■ Game-Rock

This mode is suitable for games with rock content.

■ Game-RPG

This mode is suitable for role-playing games.

■ Game-Sports

This mode is suitable for sports games.

■ Mono

In this mode, when the input signal is analog or PCM, the left and right front speakers output the sound in monaural.

■ Multich (Multichannel)

This mode is suitable to play sources recorded in multichannel PCM.

■ Orchestra

This mode is suitable for classical or operatic music. This mode emphasizes the surround channels in order to widen the sound image, and simulates the natural reverberation of a large hall.

■ Pure Audio

This mode reproduces the original sound more faithfully. The display and analog video circuit are turned off to provide purer sound.

Note that the sound adjustment is not available when this mode is selected.

- Selecting this mode turns off the analog video circuit, so the video signals input through jacks other than the HDMI IN jack cannot be displayed on the TV.
- This cannot be selected when using the Multi-zone function. Activating the Multi-zone function while this mode is selected will automatically switch the listening mode to Direct.

■ Stereo

In this mode, sound is output from the right and left front speakers and subwoofer.

■ Studio-Mix

This mode is suitable for rock or pop music. This mode creates a lively sound field with a powerful acoustic image as if you are at a club or rock concert.

■ T-D (Theater-Dimensional)

In this mode, you can enjoy a virtual playback of multichannel surround sound even with only two or three speakers. This works by controlling how sounds reach the listener's left and right ears.

■ THX

THX is a series of specifications for the accurate reproduction of movies propounded by the film director George Lucas. THX listening modes include the THX Cinema mode, etc. Using technology such as THX Loudness Plus and Timbre Matching, the sound of a movie theater is reproduced accurately.

THX technology:

A movie soundtrack is mixed in a large-scale theater specially made for mixing that is called a dubbing stage on the assumption that the soundtrack is played in such theaters with similar equipment and conditions. These soundtracks are recorded as is, even when recording to a DVD-Video, for example, without making any modifications to suit a home theater environment. THX technology is able to reproduce the movie theater sound accurately in a home theater environment by minimizing acoustic and spatial deviation.

- THX Loudness Plus

THX Loudness Plus is a new volume control technology mounted on THX Ultra and THX Select-certified AV receivers. With THX Loudness Plus, home theater audience can experience the rich details of surround sound at any volume level. If the volume is turned down below the reference level, elements of sound in a certain range are lost, or the sound is perceived differently by audience. THX Loudness Plus compensates for the tonal and spatial shifts that occur when the volume is reduced, by intelligently adjusting ambient surround channel levels and frequency response.

- Re-EQ

The speakers for the front channel in a movie theater are installed behind the screen. For this reason the high range is enhanced in the sound track of the front channel in view of acoustic characteristics such as the necessity to penetrate the screen. Re-EQ adjusts the soundtrack with the enhanced high range to make it suitable for a home theater.

- Timbre Matching

The perception of human ears differs depending on the sound direction. Movie theaters have many surround speakers installed, so they are excellent at surrounding the viewers with natural sound, but home theaters have only two surround speakers installed. The Timbre Matching function filters the signals sent to the surround speakers, and adjusts the tonal characteristics of front speakers and surround speakers to create smooth sound movement from front speakers to surround speakers.

- Adaptive Decorrelation

While movie theaters have many surround speakers to enable the experience where viewers are surrounded with sound, home theaters normally have only two surround speakers. Such two surround speakers give a headphone-like sound, not a broad and embracing surround sound. If a listener moves away from the middle position between the surround speakers, the sound from the surround speakers is absorbed into the sound from the nearby speakers, and cannot be distinguished any more. Adaptive Decorrelation changes the time axis and phase between the surround channels so that you can enjoy the same spatial sound with two surround speakers as in a movie theater.

- ASA (Advanced Speaker Array)

ASA is a technology patented by THX to provide a broad surround sound experience by adjusting the sounds of two surround speakers on the sides and two surround speakers at the back. When installing the surround back speakers, be sure to select the distance between the two surround back speakers in the THX Audio settings. This setting optimizes the surround sound environment.

THX listening modes:

- THX Cinema: Use this mode in a home theater environment to play the soundtrack that was recorded on the assumption that it is played in a movie theater or similar large area. In this mode, THX Loudness Plus is set to the theater level, and Re-EQ, Timbre Matching and Adaptive Decorrelation are all enabled.
- THX Games: Use this mode for high-fidelity spatial reproduction of game sound. THX Loudness Plus is set to a level suited to the audio level of the game, and Timbre Matching is enabled.
- THX Music: This mode mainly adjusts the playback of music sources that are mastered to a much higher quality obviously than movie audio. In this mode,

THX Loudness Plus is set to a level suited to the playback of music, and Timbre Matching is enabled.

- THX Sel Cin (THX Select Cinema): The THX Select Cinema mode provides a high-quality surround sound experience by expanding movie sources recorded in 5.1ch for 7.1ch playback. In this mode, the THX ASA processing technology gives smooth transition between side and back surround sounds, creating the best atmosphere and directional sense of surround sound.
- THX Sel Gam (THX Select Games): Select the THX Select Games mode to play game sound recorded in a multichannel format. In this mode, the THX ASA processing technology enables the playback of game sound in a 360-degree sound field which was recorded in PCM, DTS, Dolby Digital and other 5.1ch formats.
- THX Sel Mus (THX Select Music): Select THX Select Music to play music sources recorded in a multichannel format. In this mode, the THX ASA processing technology creates a broad and stable back sound field when playing music sources recorded in 5.1ch, such as DTS, Dolby Digital, and DVD-Audio.

■ TV Logic

Suitable for TV shows produced in a TV studio. This mode gives clarity to voices by enhancing the entire surround sounds, and creates a realistic acoustic image.

■ Unplugged

Suitable for acoustic instruments, vocals and jazz. This mode emphasizes the front sound field image, giving the impression of being in front of the stage.

Selectable listening modes

You can select a variety of listening modes according to the audio format of the signal to be input.

- List of listening modes selectable with the MOVIE/TV button (→[p112](#))
- List of listening modes selectable with the MUSIC button (→[p116](#))
- List of listening modes selectable with the GAME button (→[p120](#))
- Selectable listening modes when headphones are connected are Pure Audio, Mono, Direct, and Stereo only.

■ MOVIE/TV button

Input Format	Listening Mode
Analog	Direct
	Mono
	<input checked="" type="checkbox"/> DSur
	DTS Neural:X
	THX Cinema ^{*1}
	TV Logic ^{*2}
	AllCh Stereo ^{*3}
	Full Mono ^{*3}
	T-D

^{*1} Surround speakers need to be installed.

^{*2} Surround speakers or height speakers need to be installed.

^{*3} A center speaker, surround speakers, or height speakers need to be installed.

Input Format	Listening Mode
PCM Music files (except DSD/ Dolby TrueHD)	Direct
	Mono
	<input checked="" type="checkbox"/> DSur
	DTS Neural:X ^{*1}
	THX Cinema ^{*2}
	TV Logic ^{*3}
	AllCh Stereo ^{*4}
	Full Mono ^{*4}
T-D	

^{*1} Cannot be selected when the input format is monaural.

^{*2} Surround speakers need to be installed.

^{*3} Surround speakers or height speakers need to be installed.

^{*4} A center speaker, surround speakers, or height speakers need to be installed.

Input Format	Listening Mode
Multich PCM	Direct
	Multich ^{*1}
	<input checked="" type="checkbox"/> DSur
	DTS Neural:X
	THX Cinema ^{*2}
	THX Sel Cin ^{*3}
	TV Logic ^{*4}
	AllCh Stereo ^{*5}
	Full Mono ^{*5}
	T-D

^{*1} A center speaker or surround speakers need to be installed.

^{*2} Surround speakers need to be installed.

^{*3} Surround back speakers need to be installed. Can be selected when the input format is 5.1 ch.

^{*4} Surround speakers or height speakers need to be installed.

^{*5} A center speaker, surround speakers, or height speakers need to be installed.

Input Format	Listening Mode
DSD <ul style="list-style-type: none"> When the sampling rate is 11.2 MHz you can only select the Direct listening mode. 	Direct
	DSD ^{*1 *2}
	<input checked="" type="checkbox"/> DSur
	DTS Neural:X
	THX Cinema ^{*3}
	THX Sel Cin ^{*4}
	TV Logic ^{*5}
	AllCh Stereo ^{*6}
	Full Mono ^{*6}
	T-D

^{*1} Cannot be selected when the input format is monaural or 2 ch.

^{*2} A center speaker or surround speakers need to be installed.

^{*3} Surround speakers need to be installed.

^{*4} Surround back speakers need to be installed. Can be selected when the input format is 5.1 ch.

^{*5} Surround speakers or height speakers need to be installed.

^{*6} A center speaker, surround speakers, or height speakers need to be installed.

Input Format	Listening Mode
<input checked="" type="checkbox"/> DD	Direct
	<input checked="" type="checkbox"/> DD ^{*1 *2}
	<input checked="" type="checkbox"/> DSur
	DTS Neural:X ^{*3}
	THX Cinema ^{*4}
	THX Sel Cin ^{*5}
	TV Logic ^{*6}
	AllCh Stereo ^{*7}
	Full Mono ^{*7}
	T-D

^{*1} Cannot be selected when the input format is 2 ch.

^{*2} A center speaker or surround speakers need to be installed.

^{*3} Cannot be selected when the input format is monaural.

^{*4} Surround speakers need to be installed.

^{*5} Surround back speakers need to be installed. Can be selected when the input format is 5.1 ch.

^{*6} Surround speakers or height speakers need to be installed.

^{*7} A center speaker, surround speakers, or height speakers need to be installed.

Input Format	Listening Mode
<input checked="" type="checkbox"/> DD+	Direct
	<input checked="" type="checkbox"/> DD+ ^{*1 *2}
	<input checked="" type="checkbox"/> DSur
	DTS Neural:X ^{*3}
	THX Cinema ^{*4}
	THX Sel Cin ^{*5}
	TV Logic ^{*6}
	AllCh Stereo ^{*7}
	Full Mono ^{*7}
	T-D

^{*1} Cannot be selected when the input format is 2 ch.

^{*2} A center speaker or surround speakers need to be installed.

^{*3} Cannot be selected when the input format is monaural.



^{*4} Surround speakers need to be installed.

^{*5} Surround back speakers need to be installed. Can be selected when the input format is 5.1 ch.

^{*6} Surround speakers or height speakers need to be installed.

^{*7} A center speaker, surround speakers, or height speakers need to be installed.

Input Format	Listening Mode
Dolby Atmos <ul style="list-style-type: none"> You can select the <input checked="" type="checkbox"/> DD+ or <input checked="" type="checkbox"/> DTHD listening mode if surround back speakers or height speakers are not connected. 	Direct
	Dolby Atmos
	TV Logic
	AllCh Stereo
	Full Mono
T-D	

Input Format	Listening Mode
 DTHD	Direct
	 DTHD ^{*1 *2}
	 DSur
	DTS Neural:X ^{*3}
	THX Cinema ^{*4}
	THX Sel Cin ^{*5}
	TV Logic ^{*6}
	AllCh Stereo ^{*7}
	Full Mono ^{*7}
	T-D

^{*1} Cannot be selected when the input format is 2 ch.

^{*2} A center speaker or surround speakers need to be installed.

^{*3} Cannot be selected when the input format is monaural.

^{*4} Surround speakers need to be installed.

^{*5} Surround back speakers need to be installed. Can be selected when the input format is 5.1 ch.

^{*6} Surround speakers or height speakers need to be installed.

^{*7} A center speaker, surround speakers, or height speakers need to be installed.

Input Format	Listening Mode
DTS	Direct
	DTS ^{*1 *2}
	 DSur
	DTS Neural:X ^{*3}
	THX Cinema ^{*4}
	THX Sel Cin ^{*5}
	TV Logic ^{*6}
	AllCh Stereo ^{*7}
	Full Mono ^{*7}
	T-D

^{*1} Cannot be selected when the input format is 2 ch.

^{*2} A center speaker or surround speakers need to be installed.

^{*3} Cannot be selected when the input format is monaural.

^{*4} Surround speakers need to be installed.

^{*5} Surround back speakers need to be installed. Can be selected when the input format is 5.1 ch.

^{*6} Surround speakers or height speakers need to be installed.

^{*7} A center speaker, surround speakers, or height speakers need to be installed.

Input Format	Listening Mode
DTS 96/24	Direct
	DTS 96/24 ^{*1 *2}
	 DSur
	DTS Neural:X ^{*3}
	THX Cinema ^{*4}
	THX Sel Cin ^{*5}
	TV Logic ^{*6}
	AllCh Stereo ^{*7}
	Full Mono ^{*7}
	T-D

^{*1} Cannot be selected when the input format is 2 ch.

^{*2} A center speaker or surround speakers need to be installed.

^{*3} Cannot be selected when the input format is monaural.

^{*4} Surround speakers need to be installed.

^{*5} Surround back speakers need to be installed. Can be selected when the input format is 5.1 ch.

^{*6} Surround speakers or height speakers need to be installed.

^{*7} A center speaker, surround speakers, or height speakers need to be installed.

Input Format	Listening Mode
DTS Express	Direct
	DTS Express ^{1 2}
	 DSur
	DTS Neural:X ³
	THX Cinema ⁴
	THX Sel Cin ⁵
	TV Logic ⁶
	AllCh Stereo ⁷
	Full Mono ⁷
	T-D

Input Format	Listening Mode
DTS-HD HR	Direct
	DTS-HD HR ^{1 2}
	 DSur
	DTS Neural:X ³
	THX Cinema ⁴
	THX Sel Cin ⁵
	TV Logic ⁶
	AllCh Stereo ⁷
	Full Mono ⁷
	T-D

Input Format	Listening Mode
DTS-HD MSTR	Direct
	DTS-HD MSTR ^{1 2}
	 DSur
	DTS Neural:X ³
	THX Cinema ⁴
	THX Sel Cin ⁵
	TV Logic ⁶
	AllCh Stereo ⁷
	Full Mono ⁷
	T-D

¹ Cannot be selected when the input format is 2 ch.

² A center speaker or surround speakers need to be installed.

³ Cannot be selected when the input format is monaural.

⁴ Surround speakers need to be installed.

⁵ Surround back speakers need to be installed. Can be selected when the input format is 5.1 ch.

⁶ Surround speakers or height speakers need to be installed.

⁷ A center speaker, surround speakers, or height speakers need to be installed.

¹ Cannot be selected when the input format is 2 ch.

² A center speaker or surround speakers need to be installed.

³ Cannot be selected when the input format is monaural.

⁴ Surround speakers need to be installed.

⁵ Surround back speakers need to be installed. Can be selected when the input format is 5.1 ch.

⁶ Surround speakers or height speakers need to be installed.

⁷ A center speaker, surround speakers, or height speakers need to be installed.

¹ Cannot be selected when the input format is 2 ch.

² A center speaker or surround speakers need to be installed.

³ Cannot be selected when the input format is monaural.

⁴ Surround speakers need to be installed.

⁵ Surround back speakers need to be installed. Can be selected when the input format is 5.1 ch.

⁶ Surround speakers or height speakers need to be installed.

⁷ A center speaker, surround speakers, or height speakers need to be installed.

Input Format	Listening Mode
DTS-ES	Direct
	DTS ¹
	ES Matrix ²
	ES Discrete ²
	 DSur
	DTS Neural:X
	THX Cinema ³
	TV Logic ⁴
	AllCh Stereo ⁵
	Full Mono ⁵
	T-D

¹ This can only be selected when no surround back speaker is connected.

² Surround back speakers need to be installed.

³ Surround speakers need to be installed.

⁴ Surround speakers or height speakers need to be installed.

⁵ A center speaker, surround speakers, or height speakers need to be installed.

Input Format	Listening Mode
DTS:X	Direct
	DTS:X
	TV Logic ¹
	AllCh Stereo ²
	Full Mono ²
	T-D

¹ Surround speakers or height speakers need to be installed.

² A center speaker, surround speakers, or height speakers need to be installed.

MUSIC button

Input Format	Listening Mode
Analog	Pure Audio
	Direct
	Stereo
	 DSur
	DTS Neural:X
	THX Music ¹
	Orchestra ²
	Unplugged ²
	Studio-Mix ²
	AllCh Stereo ³
	Full Mono ³

¹ Surround speakers need to be installed.

² Surround speakers or height speakers need to be installed.

³ A center speaker, surround speakers, or height speakers need to be installed.

Input Format	Listening Mode
PCM Music files (except DSD/ Dolby TrueHD)	Pure Audio
	Direct
	Stereo
	 DSur
	DTS Neural:X ¹
	THX Music ²
	Orchestra ³
	Unplugged ³
	Studio-Mix ³
	AllCh Stereo ⁴
	Full Mono ⁴

¹ Cannot be selected when the input format is monaural.

² Surround speakers need to be installed.

³ Surround speakers or height speakers need to be installed.

⁴ A center speaker, surround speakers, or height speakers need to be installed.

Input Format	Listening Mode
Multich PCM	Pure Audio
	Direct
	Stereo
	Multich ¹
	 DSur
	DTS Neural:X
	THX Music ²
	THX Sel Mus ³
	Orchestra ⁴
	Unplugged ⁴
	Studio-Mix ⁴
AllCh Stereo ⁵	
Full Mono ⁵	

¹ A center speaker or surround speakers need to be installed.

² Surround speakers need to be installed.

³ Surround back speakers need to be installed. Can be selected when the input format is 5.1 ch.

⁴ Surround speakers or height speakers need to be installed.

⁵ A center speaker, surround speakers, or height speakers need to be installed.

Input Format	Listening Mode
DSD • When the sampling rate is 11.2 MHz you can only select the Direct listening mode.	Pure Audio
	Direct
	Stereo
	DSD ^{*1 *2}
	<input checked="" type="checkbox"/> DSUR
	DTS Neural:X
	THX Music ^{*3}
	THX Sel Mus ^{*4}
	Orchestra ^{*5}
	Unplugged ^{*5}
	Studio-Mix ^{*5}
	AllCh Stereo ^{*6}
	Full Mono ^{*6}

^{*1} Cannot be selected when the input format is monaural or 2 ch.

^{*2} A center speaker or surround speakers need to be installed.

^{*3} Surround speakers need to be installed.

^{*4} Surround back speakers need to be installed. Can be selected when the input format is 5.1 ch.

^{*5} Surround speakers or height speakers need to be installed.

^{*6} A center speaker, surround speakers, or height speakers need to be installed.

Input Format	Listening Mode
<input checked="" type="checkbox"/> DD	Pure Audio
	Direct
	Stereo
	<input checked="" type="checkbox"/> DD ^{*1 *2}
	<input checked="" type="checkbox"/> DSUR
	DTS Neural:X ^{*3}
	THX Music ^{*4}
	THX Sel Mus ^{*5}
	Orchestra ^{*6}
	Unplugged ^{*6}
	Studio-Mix ^{*6}
AllCh Stereo ^{*7}	
Full Mono ^{*7}	

^{*1} Cannot be selected when the input format is 2 ch.

^{*2} A center speaker or surround speakers need to be installed.

^{*3} Cannot be selected when the input format is monaural.

^{*4} Surround speakers need to be installed.

^{*5} Surround back speakers need to be installed. Can be selected when the input format is 5.1 ch.

^{*6} Surround speakers or height speakers need to be installed.

^{*7} A center speaker, surround speakers, or height speakers need to be installed.

Input Format	Listening Mode
<input checked="" type="checkbox"/> DD+	Pure Audio
	Direct
	Stereo
	<input checked="" type="checkbox"/> DD+ ^{*1 *2}
	<input checked="" type="checkbox"/> DSUR
	DTS Neural:X ^{*3}
	THX Music ^{*4}
	THX Sel Mus ^{*5}
	Orchestra ^{*6}
	Unplugged ^{*6}
	Studio-Mix ^{*6}
AllCh Stereo ^{*7}	
Full Mono ^{*7}	

^{*1} Cannot be selected when the input format is 2 ch.

^{*2} A center speaker or surround speakers need to be installed.

^{*3} Cannot be selected when the input format is monaural.

^{*4} Surround speakers need to be installed.

^{*5} Surround back speakers need to be installed. Can be selected when the input format is 5.1 ch.

^{*6} Surround speakers or height speakers need to be installed.

^{*7} A center speaker, surround speakers, or height speakers need to be installed.

Input Format	Listening Mode
Dolby Atmos • You can select the <input checked="" type="checkbox"/> DD+ or <input checked="" type="checkbox"/> DTHD listening mode if surround back speakers or height speakers are not connected.	Pure Audio
	Direct
	Stereo
	Dolby Atmos
	Orchestra
	Unplugged
	Studio-Mix
	AllCh Stereo
Full Mono	

Input Format	Listening Mode
<input checked="" type="checkbox"/> DTHD	Pure Audio
	Direct
	Stereo
	<input checked="" type="checkbox"/> DTHD ^{*1 *2}
	<input checked="" type="checkbox"/> DSur
	DTS Neural:X ^{*3}
	THX Music ^{*4}
	THX Sel Mus ^{*5}
	Orchestra ^{*6}
	Unplugged ^{*6}
	Studio-Mix ^{*6}
	AllCh Stereo ^{*7}
	Full Mono ^{*7}

^{*1} Cannot be selected when the input format is 2 ch.

^{*2} A center speaker or surround speakers need to be installed.

^{*3} Cannot be selected when the input format is monaural.

^{*4} Surround speakers need to be installed.

^{*5} Surround back speakers need to be installed. Can be selected when the input format is 5.1 ch.

^{*6} Surround speakers or height speakers need to be installed.

^{*7} A center speaker, surround speakers, or height speakers need to be installed.

Input Format	Listening Mode
DTS	Pure Audio
	Direct
	Stereo
	DTS ^{*1 *2}
	<input checked="" type="checkbox"/> DSur
	DTS Neural:X ^{*3}
	THX Music ^{*4}
	THX Sel Mus ^{*5}
	Orchestra ^{*6}
	Unplugged ^{*6}
	Studio-Mix ^{*6}
	AllCh Stereo ^{*7}
	Full Mono ^{*7}

^{*1} Cannot be selected when the input format is 2 ch.

^{*2} A center speaker or surround speakers need to be installed.

^{*3} Cannot be selected when the input format is monaural.

^{*4} Surround speakers need to be installed.

^{*5} Surround back speakers need to be installed. Can be selected when the input format is 5.1 ch.

^{*6} Surround speakers or height speakers need to be installed.

^{*7} A center speaker, surround speakers, or height speakers need to be installed.

Input Format	Listening Mode
DTS 96/24	Pure Audio
	Direct
	Stereo
	DTS 96/24 ^{*1 *2}
	<input checked="" type="checkbox"/> DSur
	DTS Neural:X ^{*3}
	THX Music ^{*4}
	THX Sel Mus ^{*5}
	Orchestra ^{*6}
	Unplugged ^{*6}
	Studio-Mix ^{*6}
	AllCh Stereo ^{*7}
	Full Mono ^{*7}

^{*1} Cannot be selected when the input format is 2 ch.

^{*2} A center speaker or surround speakers need to be installed.

^{*3} Cannot be selected when the input format is monaural.

^{*4} Surround speakers need to be installed.

^{*5} Surround back speakers need to be installed. Can be selected when the input format is 5.1 ch.

^{*6} Surround speakers or height speakers need to be installed.

^{*7} A center speaker, surround speakers, or height speakers need to be installed.

Input Format	Listening Mode
DTS Express	Pure Audio
	Direct
	Stereo
	DTS Express ¹ ²
	 DSur
	DTS Neural:X ³
	THX Music ⁴
	THX Sel Mus ⁵
	Orchestra ⁶
	Unplugged ⁶
	Studio-Mix ⁶
	AllCh Stereo ⁷
Full Mono ⁷	

¹ Cannot be selected when the input format is 2 ch.

² A center speaker or surround speakers need to be installed.

³ Cannot be selected when the input format is monaural.

⁴ Surround speakers need to be installed.

⁵ Surround back speakers need to be installed. Can be selected when the input format is 5.1 ch.

⁶ Surround speakers or height speakers need to be installed.

⁷ A center speaker, surround speakers, or height speakers need to be installed.

Input Format	Listening Mode
DTS-HD HR	Pure Audio
	Direct
	Stereo
	DTS-HD HR ¹ ²
	 DSur
	DTS Neural:X ³
	THX Music ⁴
	THX Sel Mus ⁵
	Orchestra ⁶
	Unplugged ⁶
	Studio-Mix ⁶
	AllCh Stereo ⁷
Full Mono ⁷	

¹ Cannot be selected when the input format is 2 ch.

² A center speaker or surround speakers need to be installed.

³ Cannot be selected when the input format is monaural.

⁴ Surround speakers need to be installed.

⁵ Surround back speakers need to be installed. Can be selected when the input format is 5.1 ch.

⁶ Surround speakers or height speakers need to be installed.

⁷ A center speaker, surround speakers, or height speakers need to be installed.

Input Format	Listening Mode
DTS-HD MSTR	Pure Audio
	Direct
	Stereo
	DTS-HD MSTR ¹ ²
	 DSur
	DTS Neural:X ³
	THX Music ⁴
	THX Sel Mus ⁵
	Orchestra ⁶
	Unplugged ⁶
	Studio-Mix ⁶
	AllCh Stereo ⁷
Full Mono ⁷	

¹ Cannot be selected when the input format is 2 ch.

² A center speaker or surround speakers need to be installed.

³ Cannot be selected when the input format is monaural.

⁴ Surround speakers need to be installed.

⁵ Surround back speakers need to be installed. Can be selected when the input format is 5.1 ch.

⁶ Surround speakers or height speakers need to be installed.

⁷ A center speaker, surround speakers, or height speakers need to be installed.

Input Format	Listening Mode
DTS-ES	Pure Audio
	Direct
	Stereo
	DTS ^{*1}
	ES Matrix ^{*2}
	ES Discrete ^{*2}
	 DSur
	DTS Neural:X
	THX Music ^{*3}
	Orchestra ^{*4}
	Unplugged ^{*4}
	Studio-Mix ^{*4}
	AllCh Stereo ^{*5}
	Full Mono ^{*5}

- ^{*1} This can only be selected when no surround back speaker is connected.
- ^{*2} Surround back speakers need to be installed.
- ^{*3} Surround speakers need to be installed.
- ^{*4} Surround speakers or height speakers need to be installed.
- ^{*5} A center speaker, surround speakers, or height speakers need to be installed.

Input Format	Listening Mode
DTS:X	Pure Audio
	Direct
	Stereo
	DTS:X
	Orchestra ^{*1}
	Unplugged ^{*1}
	Studio-Mix ^{*1}
	AllCh Stereo ^{*2}
	Full Mono ^{*2}

- ^{*1} Surround speakers or height speakers need to be installed.
- ^{*2} A center speaker, surround speakers, or height speakers need to be installed.

■ GAME button

Input Format	Listening Mode
Analog	Direct
	 DSur
	DTS Neural:X
	THX Games ^{*1}
	Game-RPG ^{*2}
	Game-Action ^{*2}
	Game-Rock ^{*2}
	Game-Sports ^{*2}
	AllCh Stereo ^{*3}
	Full Mono ^{*3}
	T-D

- ^{*1} Surround speakers need to be installed.
- ^{*2} Surround speakers or height speakers need to be installed.
- ^{*3} A center speaker, surround speakers, or height speakers need to be installed.

Input Format	Listening Mode
PCM Music files (except DSD/ Dolby TrueHD)	Direct
	 DSur
	DTS Neural:X ^{*1}
	THX Games ^{*2}
	Game-RPG ^{*3}
	Game-Action ^{*3}
	Game-Rock ^{*3}
	Game-Sports ^{*3}
	AllCh Stereo ^{*4}
	Full Mono ^{*4}
T-D	

- ^{*1} Cannot be selected when the input format is monaural.
- ^{*2} Surround speakers need to be installed.
- ^{*3} Surround speakers or height speakers need to be installed.
- ^{*4} A center speaker, surround speakers, or height speakers need to be installed.

Input Format	Listening Mode
Multich PCM	Direct
	Multich ^{*1}
	 DSur
	DTS Neural:X
	THX Games ^{*2}
	THX Sel Gam ^{*3}
	Game-RPG ^{*4}
	Game-Action ^{*4}
	Game-Rock ^{*4}
	Game-Sports ^{*4}
	AllCh Stereo ^{*5}
Full Mono ^{*5}	
T-D	

- ^{*1} A center speaker or surround speakers need to be installed.
- ^{*2} Surround speakers need to be installed.
- ^{*3} Surround back speakers need to be installed. Can be selected when the input format is 5.1 ch.
- ^{*4} Surround speakers or height speakers need to be installed.
- ^{*5} A center speaker, surround speakers, or height speakers need to be installed.

Input Format	Listening Mode
DSD • When the sampling rate is 11.2 MHz you can only select the Direct listening mode.	Direct
	DSD ^{*1 *2}
	<input checked="" type="checkbox"/> DSur
	DTS Neural:X
	THX Games ^{*3}
	THX Sel Gam ^{*4}
	Game-RPG ^{*5}
	Game-Action ^{*5}
	Game-Rock ^{*5}
	Game-Sports ^{*5}
	AllCh Stereo ^{*6}
	Full Mono ^{*6}
	T-D

Input Format	Listening Mode
<input checked="" type="checkbox"/> DD	Direct
	<input checked="" type="checkbox"/> DD ^{*1 *2}
	<input checked="" type="checkbox"/> DSur
	DTS Neural:X ^{*3}
	THX Games ^{*4}
	THX Sel Gam ^{*5}
	Game-RPG ^{*6}
	Game-Action ^{*6}
	Game-Rock ^{*6}
	Game-Sports ^{*6}
AllCh Stereo ^{*7}	
Full Mono ^{*7}	
T-D	

Input Format	Listening Mode
<input checked="" type="checkbox"/> DD+	Direct
	<input checked="" type="checkbox"/> DD+ ^{*1 *2}
	<input checked="" type="checkbox"/> DSur
	DTS Neural:X ^{*3}
	THX Games ^{*4}
	THX Sel Gam ^{*5}
	Game-RPG ^{*6}
	Game-Action ^{*6}
	Game-Rock ^{*6}
	Game-Sports ^{*6}
AllCh Stereo ^{*7}	
Full Mono ^{*7}	
T-D	

*1 Cannot be selected when the input format is monaural or 2 ch.

*2 A center speaker or surround speakers need to be installed.

*3 Surround speakers need to be installed.

*4 Surround back speakers need to be installed. Can be selected when the input format is 5.1 ch.

*5 Surround speakers or height speakers need to be installed.

*6 A center speaker, surround speakers, or height speakers need to be installed.

*1 Cannot be selected when the input format is 2 ch.

*2 A center speaker or surround speakers need to be installed.

*3 Cannot be selected when the input format is monaural.

*4 Surround speakers need to be installed.

*5 Surround back speakers need to be installed. Can be selected when the input format is 5.1 ch.

*6 Surround speakers or height speakers need to be installed.

*7 A center speaker, surround speakers, or height speakers need to be installed.

*1 Cannot be selected when the input format is 2 ch.

*2 A center speaker or surround speakers need to be installed.

*3 Cannot be selected when the input format is monaural.

*4 Surround speakers need to be installed.

*5 Surround back speakers need to be installed. Can be selected when the input format is 5.1 ch.

*6 Surround speakers or height speakers need to be installed.

*7 A center speaker, surround speakers, or height speakers need to be installed.

Input Format	Listening Mode
Dolby Atmos • You can select the <input checked="" type="checkbox"/> DD+ or <input checked="" type="checkbox"/> DTHD listening mode if surround back speakers or height speakers are not connected.	Direct
	Dolby Atmos
	Game-RPG
	Game-Action
	Game-Rock
	Game-Sports
	AllCh Stereo
	Full Mono
T-D	

Input Format	Listening Mode
<input checked="" type="checkbox"/> DTHD	Direct
	<input checked="" type="checkbox"/> DTHD ^{*1 *2}
	<input checked="" type="checkbox"/> DSur
	DTS Neural:X ^{*3}
	THX Games ^{*4}
	THX Sel Gam ^{*5}
	Game-RPG ^{*6}
	Game-Action ^{*6}
	Game-Rock ^{*6}
	Game-Sports ^{*6}
	AllCh Stereo ^{*7}
	Full Mono ^{*7}
T-D	

^{*1} Cannot be selected when the input format is 2 ch.

^{*2} A center speaker or surround speakers need to be installed.

^{*3} Cannot be selected when the input format is monaural.

^{*4} Surround speakers need to be installed.

^{*5} Surround back speakers need to be installed. Can be selected when the input format is 5.1 ch.

^{*6} Surround speakers or height speakers need to be installed.

^{*7} A center speaker, surround speakers, or height speakers need to be installed.

Input Format	Listening Mode
DTS	Direct
	DTS ^{*1 *2}
	<input checked="" type="checkbox"/> DSur
	DTS Neural:X ^{*3}
	THX Games ^{*4}
	THX Sel Gam ^{*5}
	Game-RPG ^{*6}
	Game-Action ^{*6}
	Game-Rock ^{*6}
	Game-Sports ^{*6}
	AllCh Stereo ^{*7}
	Full Mono ^{*7}
T-D	

^{*1} Cannot be selected when the input format is 2 ch.

^{*2} A center speaker or surround speakers need to be installed.

^{*3} Cannot be selected when the input format is monaural.

^{*4} Surround speakers need to be installed.

^{*5} Surround back speakers need to be installed. Can be selected when the input format is 5.1 ch.

^{*6} Surround speakers or height speakers need to be installed.

^{*7} A center speaker, surround speakers, or height speakers need to be installed.

Input Format	Listening Mode
DTS 96/24	Direct
	DTS 96/24 ^{*1 *2}
	<input checked="" type="checkbox"/> DSur
	DTS Neural:X ^{*3}
	THX Games ^{*4}
	THX Sel Gam ^{*5}
	Game-RPG ^{*6}
	Game-Action ^{*6}
	Game-Rock ^{*6}
	Game-Sports ^{*6}
	AllCh Stereo ^{*7}
	Full Mono ^{*7}
T-D	

^{*1} Cannot be selected when the input format is 2 ch.

^{*2} A center speaker or surround speakers need to be installed.

^{*3} Cannot be selected when the input format is monaural.

^{*4} Surround speakers need to be installed.

^{*5} Surround back speakers need to be installed. Can be selected when the input format is 5.1 ch.

^{*6} Surround speakers or height speakers need to be installed.

^{*7} A center speaker, surround speakers, or height speakers need to be installed.

Input Format	Listening Mode
DTS Express	Direct
	DTS Express ^{*1 *2}
	 DSur
	DTS Neural:X ^{*3}
	THX Games ^{*4}
	THX Sel Gam ^{*5}
	Game-RPG ^{*6}
	Game-Action ^{*6}
	Game-Rock ^{*6}
	Game-Sports ^{*6}
	AllCh Stereo ^{*7}
	Full Mono ^{*7}
	T-D

Input Format	Listening Mode
DTS-HD HR	Direct
	DTS-HD HR ^{*1 *2}
	 DSur
	DTS Neural:X ^{*3}
	THX Games ^{*4}
	THX Sel Gam ^{*5}
	Game-RPG ^{*6}
	Game-Action ^{*6}
	Game-Rock ^{*6}
	Game-Sports ^{*6}
	AllCh Stereo ^{*7}
	Full Mono ^{*7}
	T-D

Input Format	Listening Mode
DTS-HD MSTR	Direct
	DTS-HD MSTR ^{*1 *2}
	 DSur
	DTS Neural:X ^{*3}
	THX Games ^{*4}
	THX Sel Gam ^{*5}
	Game-RPG ^{*6}
	Game-Action ^{*6}
	Game-Rock ^{*6}
	Game-Sports ^{*6}
	AllCh Stereo ^{*7}
	Full Mono ^{*7}
	T-D

*1 Cannot be selected when the input format is 2 ch.

*2 A center speaker or surround speakers need to be installed.

*3 Cannot be selected when the input format is monaural.

*4 Surround speakers need to be installed.

*5 Surround back speakers need to be installed. Can be selected when the input format is 5.1 ch.

*6 Surround speakers or height speakers need to be installed.

*7 A center speaker, surround speakers, or height speakers need to be installed.

*1 Cannot be selected when the input format is 2 ch.

*2 A center speaker or surround speakers need to be installed.

*3 Cannot be selected when the input format is monaural.

*4 Surround speakers need to be installed.

*5 Surround back speakers need to be installed. Can be selected when the input format is 5.1 ch.

*6 Surround speakers or height speakers need to be installed.

*7 A center speaker, surround speakers, or height speakers need to be installed.

*1 Cannot be selected when the input format is 2 ch.

*2 A center speaker or surround speakers need to be installed.

*3 Cannot be selected when the input format is monaural.

*4 Surround speakers need to be installed.

*5 Surround back speakers need to be installed. Can be selected when the input format is 5.1 ch.

*6 Surround speakers or height speakers need to be installed.

*7 A center speaker, surround speakers, or height speakers need to be installed.

Input Format	Listening Mode
DTS-ES	Direct
	DTS ^{*1}
	ES Matrix ^{*2}
	ES Discrete ^{*2}
	<input checked="" type="checkbox"/> DSur
	DTS Neural:X
	THX Games ^{*3}
	Game-RPG ^{*4}
	Game-Action ^{*4}
	Game-Rock ^{*4}
	Game-Sports ^{*4}
	AllCh Stereo ^{*5}
	Full Mono ^{*5}
T-D	

^{*1} This can only be selected when no surround back speaker is connected.

^{*2} Surround back speakers need to be installed.

^{*3} Surround speakers need to be installed.

^{*4} Surround speakers or height speakers need to be installed.

^{*5} A center speaker, surround speakers, or height speakers need to be installed.

Input Format	Listening Mode
DTS:X	Direct
	DTS:X
	Game-RPG ^{*1}
	Game-Action ^{*1}
	Game-Rock ^{*1}
	Game-Sports ^{*1}
	AllCh Stereo ^{*2}
	Full Mono ^{*2}
T-D	

^{*1} Surround speakers or height speakers need to be installed.

^{*2} A center speaker, surround speakers, or height speakers need to be installed.

Setup Menu

Menu list

You can configure advanced settings to have a more enjoyable experience with this unit. For operation details, refer to "Menu operations". (→[p127](#))

1. Input/Output Assign	1. TV Out / OSD	Make settings for TV output and On-Screen Displays (OSD) that appear on the TV.	p128
	2. HDMI Input	Change input assignment between the input selectors and HDMI IN jacks.	p129
	3. Video Input	Change input assignment between the input selectors and COMPONENT VIDEO IN jacks and the VIDEO IN jacks.	p130
	4. Digital Audio Input	Change input assignment between the input selectors and DIGITAL IN COAXIAL/OPTICAL jacks.	p131
	5. Analog Audio Input	Change input assignment between the input selectors and AUDIO IN jacks.	p131
2. Speaker	1. Configuration	Change the settings of connection environment of the speakers.	p132
	2. Crossover	Change the settings of crossover frequencies.	p133
	3. Distance	Set the distance from each speaker to the listening position.	p134
	4. Level Calibration	Adjust the volume level of each speaker.	p135
	5. Dolby Enabled Speaker	Change the settings of Dolby Enabled Speakers.	p136
	6. Equalizer Settings	Adjust the output volume of the range for each connected speaker.	p136
	7. THX Audio	Change the THX Audio settings.	p137
3. Audio Adjust	1. Multiplex/Mono	Change the settings of multiplex audio playback.	p138
	2. Dolby	Change the setting of when Dolby signals are input.	p138
	3. DTS	Change the setting of when DTS signals are input.	p138
	4. LFE Level	Set the low-frequency effect (LFE) level for Dolby Digital series, DTS series, Multichannel PCM, and DSD signals.	p138
	5. Volume	Change the Volume settings.	p139

4. Source	1. IntelliVolume	Adjust the volume level when there are differences in volume level among multiple devices connected to this unit.	p139
	2. Name Edit	Set an easy name for each input.	p139
	Audio Select	Select the priority for input selection when multiple audio sources are connected to one input selector.	p140
	Video Select	When "TUNER", "NET", or "BLUETOOTH" input is selected, you can set the input from which video is displayed on the TV.	p140
5. Hardware	1. HDMI	Change the settings for the HDMI functions.	p141
	2. Network	Change the settings for the Network functions.	p142
	3. Bluetooth	Change the settings for the Bluetooth function.	p144
	4. Power Management	Change the settings for the power-save function.	p144
	5. 12V Trigger	Change the settings for 12V Trigger OUT jack.	p145
6. Multi Zone	1. Zone 2	Change the settings for Zone 2.	p146
	2. Zone 3	Change the settings for Zone 3.	p146
	3. Remote Play Zone	Change the settings for remote play.	p146
7. Miscellaneous	1. Tuner	Change the frequency step for the tuner.	p147
	2. Remote ID	Change the remote controller ID.	p147
	3. Firmware Update	Change the settings for Firmware Update.	p147
	4. Initial Setup	Make the initial setup from the setup menu.	p147
	5. Lock	Lock the Setup menu so that the settings cannot be changed.	p147

Menu operations

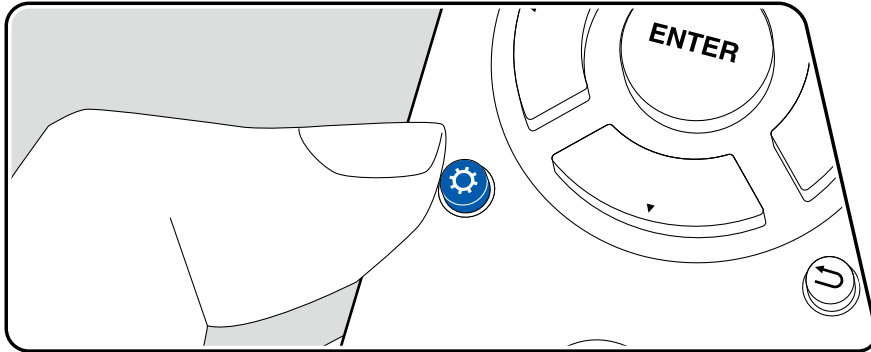

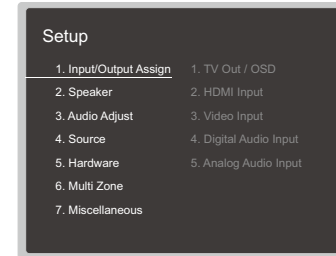

Use the on-screen displays (OSD) that appear on the TV to make the settings. Press  on the remote controller to display the Setup menu.



Select the item with the cursors ▲/▼ of the remote controller, and press ENTER to confirm your selection.

Use the cursors ◀/▶ to change the default values.

- To return to the previous screen, press .
- To exit the settings, press .

1. Input/Output Assign

1. TV Out / OSD

Make settings for TV output and On-Screen Displays (OSD) that appear on the TV.

Setting Item	Default Value	Setting Details
HDMI Out	MAIN	Select the HDMI jack to be connected with the TV. "MAIN": When connecting the TV to the HDMI OUT MAIN jack "SUB": When connecting the TV to the HDMI OUT SUB jack "MAIN+SUB": When connecting to both the MAIN and SUB jacks
Dolby Vision	MAIN	To output Dolby Vision video from the player to a TV that supports Dolby Vision, select either the HDMI OUT MAIN jack or HDMI OUT SUB jack to which the Dolby Vision-supported TV is connected. This setting is only necessary if you have set "HDMI Out" to "MAIN+SUB" and you have connected a TV to both the MAIN and SUB jacks. "MAIN": To output Dolby Vision video to a Dolby Vision-supported TV connected to the HDMI OUT MAIN jack. "SUB": To output Dolby Vision video to a Dolby Vision-supported TV connected to the HDMI OUT SUB jack. <ul style="list-style-type: none"> After selecting "MAIN" or "SUB", if the video on the TV does not appear correctly, set this to "Off".
Zone 2 HDMI	Not Use	Make the setting when you output to the Zone 2 TV connected to the HDMI OUT ZONE 2/SUB jack. "Use": Enable this function "Not Use": Disable this function

Setting Item	Default Value	Setting Details
OSD Language	English	Select the on-screen display language from the following. (North American models) English, German, French, Spanish, Italian, Dutch, Swedish (European, Australian and Asian models) English, German, French, Spanish, Italian, Dutch, Swedish, Russian, Chinese
Impose OSD	On	Set whether or not to display information such as volume adjustment or switching of input on the TV screen. "On": OSD is displayed on the TV. "Off": OSD is not displayed on the TV. <ul style="list-style-type: none"> OSD may not be displayed depending on the input signal even if "On" is selected. In this case, change the resolution of the connected device.
Mini Player OSD	Always On	You can display on the TV the images from another input selected last while playing the audio from NET or BLUETOOTH input. After switching the input to NET or BLUETOOTH, play the images and audio. And then when you press MODE on the remote controller, the image is displayed in full-screen mode, and the audio information (Mini Player) for NET or BLUETOOTH is displayed in the corner of the screen. You can set whether to always display this Mini Player on the screen. "Always On": The Mini Player is always displayed. "Auto Off": The Mini Player turns off automatically in 30 seconds after displayed. If operation such as changing the volume is performed, it is displayed again for 30 seconds. <ul style="list-style-type: none"> Each time the MODE button is pressed, the image display/non-display can be switched. This setting cannot be selected if "Impose OSD" is set to "Off".
Screen Saver	3 minutes	Set the time to start the screen saver. Select a value from "3 minutes", "5 minutes", "10 minutes" and "Off".

■ 2. HDMI Input

Change input assignment between the input selectors and HDMI IN jacks.

Setting Item	Default Value	Setting Details
BD/DVD	HDMI 1 (HDCP 2.2)	"HDMI 1 (HDCP 2.2)" to "HDMI 6 (HDCP 2.2)": Assign a desired HDMI IN jack to the BD/DVD button. If you do not assign a jack, select "---". To select an HDMI IN jack already assigned to another input selector, change its setting to "---" first.
CBL/SAT	HDMI 2 (HDCP 2.2)	"HDMI 1 (HDCP 2.2)" to "HDMI 6 (HDCP 2.2)": Assign a desired HDMI IN jack to the CBL/SAT button. If you do not assign a jack, select "---". To select an HDMI IN jack already assigned to another input selector, change its setting to "---" first.
GAME	HDMI 3 (HDCP 2.2)	"HDMI 1 (HDCP 2.2)" to "HDMI 6 (HDCP 2.2)": Assign a desired HDMI IN jack to the GAME button. If you do not assign a jack, select "---". To select an HDMI IN jack already assigned to another input selector, change its setting to "---" first.
STRM BOX	HDMI 4 (HDCP 2.2)	"HDMI 1 (HDCP 2.2)" to "HDMI 6 (HDCP 2.2)": Assign a desired HDMI IN jack to the STRM BOX button. If you do not assign a jack, select "---". To select an HDMI IN jack already assigned to another input selector, change its setting to "---" first.
PC	HDMI 5 (HDCP 2.2)	"HDMI 1 (HDCP 2.2)" to "HDMI 6 (HDCP 2.2)": Assign a desired HDMI IN jack to the PC button. If you do not assign a jack, select "---". To select an HDMI IN jack already assigned to another input selector, change its setting to "---" first.
CD	---	"HDMI 1 (HDCP 2.2)" to "HDMI 6 (HDCP 2.2)": Assign a desired HDMI IN jack to the CD button. If you do not assign a jack, select "---". To select an HDMI IN jack already assigned to another input selector, change its setting to "---" first.

Setting Item	Default Value	Setting Details
TV	---	"HDMI 1 (HDCP 2.2)" to "HDMI 6 (HDCP 2.2)": Assign a desired HDMI IN jack to the TV button. If you do not assign a jack, select "---". To select an HDMI IN jack already assigned to another input selector, change its setting to "---" first.
PHONO	---	"HDMI 1 (HDCP 2.2)" to "HDMI 6 (HDCP 2.2)": Assign a desired HDMI IN jack to the PHONO button. If you do not assign a jack, select "---". To select an HDMI IN jack already assigned to another input selector, change its setting to "---" first.

3. Video Input

Change input assignment between the input selectors and COMPONENT VIDEO IN jacks and the VIDEO IN jacks. If you do not assign a jack, select "---".

Setting Item	Default Value	Setting Details
BD/DVD	COMPONENT 1	"COMPONENT 1", "COMPONENT 2": Assign the COMPONENT VIDEO IN jacks to the BD/DVD button. "VIDEO 1", "VIDEO 2": Assign a desired VIDEO IN jack to the BD/DVD button.
CBL/SAT	VIDEO 1	"COMPONENT 1", "COMPONENT 2": Assign the COMPONENT VIDEO IN jacks to the CBL/SAT button. "VIDEO 1", "VIDEO 2": Assign a desired VIDEO IN jack to the CBL/SAT button.
GAME	COMPONENT 2	"COMPONENT 1", "COMPONENT 2": Assign the COMPONENT VIDEO IN jacks to the GAME button. "VIDEO 1", "VIDEO 2": Assign a desired VIDEO IN jack to the GAME button.
STRM BOX	VIDEO 2	"COMPONENT 1", "COMPONENT 2": Assign the COMPONENT VIDEO IN jacks to the STRM BOX button. "VIDEO 1", "VIDEO 2": Assign a desired VIDEO IN jack to the STRM BOX button.
PC	---	"COMPONENT 1", "COMPONENT 2": Assign the COMPONENT VIDEO IN jacks to the PC button. "VIDEO 1", "VIDEO 2": Assign a desired VIDEO IN jack to the PC button.
CD	---	"COMPONENT 1", "COMPONENT 2": Assign the COMPONENT VIDEO IN jacks to the CD button. "VIDEO 1", "VIDEO 2": Assign a desired VIDEO IN jack to the CD button.
TV	---	"COMPONENT 1", "COMPONENT 2": Assign the COMPONENT VIDEO IN jacks to the TV button. "VIDEO 1", "VIDEO 2": Assign a desired VIDEO IN jack to the TV button.

Setting Item	Default Value	Setting Details
PHONO	---	"COMPONENT 1", "COMPONENT 2": Assign the COMPONENT VIDEO IN jacks to the PHONO button. "VIDEO 1", "VIDEO 2": Assign a desired VIDEO IN jack to the PHONO button.

■ 4. Digital Audio Input

Change input assignment between the input selectors and DIGITAL IN COAXIAL/OPTICAL jacks. If you do not assign a jack, select "---".

Setting Item	Default Value	Setting Details
BD/DVD	COAXIAL	"COAXIAL", "OPTICAL 1", "OPTICAL 2": Assign a desired DIGITAL IN jack to the BD/DVD button.
CBL/SAT	---	"COAXIAL", "OPTICAL 1", "OPTICAL 2": Assign a desired DIGITAL IN jack to the CBL/SAT button.
GAME	---	"COAXIAL", "OPTICAL 1", "OPTICAL 2": Assign a desired DIGITAL IN jack to the GAME button.
STRM BOX	---	"COAXIAL", "OPTICAL 1", "OPTICAL 2": Assign a desired DIGITAL IN jack to the STRM BOX button.
PC	---	"COAXIAL", "OPTICAL 1", "OPTICAL 2": Assign a desired DIGITAL IN jack to the PC button.
CD	OPTICAL 1	"COAXIAL", "OPTICAL 1", "OPTICAL 2": Assign a desired DIGITAL IN jack to the CD button.
TV	OPTICAL 2	"COAXIAL", "OPTICAL 1", "OPTICAL 2": Assign a desired DIGITAL IN jack to the TV button.
PHONO	---	"COAXIAL", "OPTICAL 1", "OPTICAL 2": Assign a desired DIGITAL IN jack to the PHONO button.

- Supported sampling rates for PCM signals (stereo, mono) from a digital input are 32kHz, 44.1kHz, 48kHz, 88.2kHz, 96kHz/16bit, 20bit, and 24bit.

■ 5. Analog Audio Input

Change input assignment between the input selectors and AUDIO IN jacks. If you do not assign a jack, select "---".

Setting Item	Default Value	Setting Details
BD/DVD	AUDIO 1	"AUDIO 1" to "AUDIO 6": Assign a desired AUDIO IN jack to the BD/DVD button.
CBL/SAT	AUDIO 2	"AUDIO 1" to "AUDIO 6": Assign a desired AUDIO IN jack to the CBL/SAT button.
GAME	AUDIO 3	"AUDIO 1" to "AUDIO 6": Assign a desired AUDIO IN jack to the GAME button.
STRM BOX	AUDIO 4	"AUDIO 1" to "AUDIO 6": Assign a desired AUDIO IN jack to the STRM BOX button.
PC	---	"AUDIO 1" to "AUDIO 6": Assign a desired AUDIO IN jack to the PC button.
CD	AUDIO 5	"AUDIO 1" to "AUDIO 6": Assign a desired AUDIO IN jack to the CD button.
TV	AUDIO 6	"AUDIO 1" to "AUDIO 6": Assign a desired AUDIO IN jack to the TV button.
PHONO	PHONO	The setting cannot be changed.

2. Speaker

1. Configuration

Change the settings of connection environment of the speakers.

Setting Item	Default Value	Setting Details
Speaker Channels	7.1.2 ch	Select "2.1 ch", "3.1 ch", "4.1 ch", "5.1 ch", "6.1 ch", "7.1 ch", "2.1.2 ch", "3.1.2 ch", "4.1.2 ch", "5.1.2 ch", "6.1.2 ch", "7.1.2 ch", "4.1.4 ch", "5.1.4 ch", "6.1.4 ch" or "7.1.4 ch" to suit the number of speaker channels connected.
Subwoofer	Yes	Set whether a subwoofer is connected or not. "Yes": When a subwoofer is connected "No": When a subwoofer is not connected
Height 1 Speaker	Top Middle	Set the speaker type if height speakers are connected to the HEIGHT 1 terminals. Select "Front High", "Top Front", "Top Middle", "Top Rear", "Rear High", "Dolby Speaker (Front)", "Dolby Speaker (Surr)" or "Dolby Speaker (Back)" according to the type and layout of the connected speakers. <ul style="list-style-type: none"> This setting cannot be selected under any of following conditions. Set the height speakers type to "Height 2 Speaker". <ul style="list-style-type: none"> "Bi-Amp" is set to "Yes" When "Speaker Channels" is set to "2.1.2 ch", "3.1.2 ch", "4.1.2 ch" or "5.1.2 ch", and "Zone Speaker" is set to "Zone 2" When two sets of height speakers are being used, "Top Rear", "Rear High", "Dolby Speaker (Surr)", and "Dolby Speaker (Back)" cannot be selected. "Dolby Speaker (Surr)" and "Dolby Speaker (Back)" can only be selected when surround speakers or surround back speakers are being used, respectively. You can check speakers that you are using on the figure displayed in "Speaker Channels". If an item cannot be selected even though connection is correct, check that the settings in "Speaker Channels" matches the number of connected channels.

Setting Item	Default Value	Setting Details
Height 2 Speaker	Rear High	Set the speaker type if height speakers are connected to the HEIGHT 2 terminals. Select "Front High", "Top Front", "Top Middle", "Top Rear", "Rear High", "Dolby Speaker (Front)", "Dolby Speaker (Surr)" or "Dolby Speaker (Back)" according to the type and layout of the connected speakers. However, the options selectable for the "Height 1 Speaker" the are as follows. If "Height 1 Speaker" is set to "Front High": Select from "Top Middle", "Top Rear", "Rear High", "Dolby Speaker (Surr)" or "Dolby Speaker (Back)". If "Height 1 Speaker" is set to "Top Front" or "Dolby Speaker (Front)": Select from "Top Rear", "Rear High", "Dolby Speaker (Surr)" or "Dolby Speaker (Back)". If "Height 1 Speaker" is set to "Top Middle": Fixed to "Rear High". <ul style="list-style-type: none"> "Dolby Speaker (Surr)" and "Dolby Speaker (Back)" can only be selected when surround speakers or surround back speakers are being used, respectively. You can check speakers that you are using on the figure displayed in "Speaker Channels". If an item cannot be selected even though connection is correct, check that the settings in "Speaker Channels" matches the number of connected channels.
Zone Speaker	No	Set whether speakers are connected to Zone 2 or Zone 3 speaker terminals. "Zone 2": When speakers are connected to Zone 2 speaker terminals "Zone 2/Zone 3": When connecting speaker to both ZONE 2 speaker terminal and ZONE 3 speaker terminals. <ul style="list-style-type: none"> This setting cannot be selected under any of following conditions. <ul style="list-style-type: none"> When the surround back speakers are used When 2 sets of height speakers are used "No": When speakers are not connected to Zone 2 speaker terminals

Setting Item	Default Value	Setting Details
Bi-Amp	No	Set whether the front speakers are bi-amp connected. "No": When front speakers are not bi-amp connected "Yes": When front speakers are bi-amp connected <ul style="list-style-type: none"> This setting will be set to "No" in either of following cases. <ul style="list-style-type: none"> When 2 sets of height speakers are used When surround back speakers and height speakers are being used at the same time. When "Zone Speaker" is set to "Zone 2" or "Zone 2/Zone 3"
Speaker Impedance	6ohms	Set the impedance (Ω) of the connected speakers. "4ohms": When any of the connected speakers have 4 Ω or more to less than 6 Ω impedance "6ohms": When the connected speakers all have 6 Ω or more impedance <ul style="list-style-type: none"> For impedance, check the indications on the back of the speakers or their instruction manual.

■ 2. Crossover

Change the settings of crossover frequencies.

- As for the THX-certified speakers, the following settings are recommended.
 - Crossover frequency → "80Hz(THX)"
 - "LPF of LFE" → "80Hz"
 - "Double Bass" → "Off"

Setting Item	Default Value	Setting Details
Front	80Hz(THX)	Select the crossover frequency from "40Hz" to "200Hz" to start outputting frequencies for each channel. "Full Band": Full band will be output. <ul style="list-style-type: none"> If "Configuration" - "Subwoofer" is set to "No", "Front" is fixed to "Full Band", and the low pitched range of the other channels is output from the front speakers. Refer to the instruction manual of your speakers to make the setting.

Setting Item	Default Value	Setting Details
Center	80Hz(THX)	Select the crossover frequency from "40Hz" to "200Hz" to start outputting frequencies for each channel. "Full Band": Full band will be output. <ul style="list-style-type: none"> "Full Band" can be selected only when "Front" is set to "Full Band". If the item cannot be selected even though connection is correct, check if the setting in "Configuration" - "Speaker Channels" matches the number of connected channels.
Height 1	80Hz(THX)	Select the crossover frequency from "40Hz" to "200Hz" to start outputting frequencies for each channel. "Full Band": Full band will be output. <ul style="list-style-type: none"> "Full Band" can be selected only when "Front" is set to "Full Band". If the item cannot be selected even though connection is correct, check if the setting in "Configuration" - "Speaker Channels" matches the number of connected channels.
Height 2	80Hz(THX)	Select the crossover frequency from "40Hz" to "200Hz" to start outputting frequencies for each channel. "Full Band": Full band will be output. <ul style="list-style-type: none"> "Full Band" can be selected only when "Front" is set to "Full Band". If the item cannot be selected even though connection is correct, check if the setting in "Configuration" - "Speaker Channels" matches the number of connected channels.

Setting Item	Default Value	Setting Details
Surround	80Hz(THX)	Select the crossover frequency from "40Hz" to "200Hz" to start outputting frequencies for each channel. "Full Band": Full band will be output. <ul style="list-style-type: none"> "Full Band" can be selected only when "Front" is set to "Full Band". If the item cannot be selected even though connection is correct, check if the setting in "Configuration" - "Speaker Channels" matches the number of connected channels.
Surround Back	80Hz(THX)	Select the crossover frequency from "40Hz" to "200Hz" to start outputting frequencies for each channel. "Full Band": Full band will be output. <ul style="list-style-type: none"> "Full Band" can be selected only when "Surround" is set to "Full Band". If the item cannot be selected even though connection is correct, check if the setting in "Configuration" - "Speaker Channels" matches the number of connected channels.
LPF of LFE	120Hz	Set the low-pass filter for LFE (low-frequency effect) signals in order to pass only the lower frequency signals than the set value, and thus cancel unwanted noises. The low-pass filter is effective only on sources with LFE channel. The value from "80Hz" to "120Hz" can be set. "Off": When this function is not used
Double Bass	On	This can be selected only when "Configuration" - "Subwoofer" is set to "Yes" and "Front" is set to "Full Band". Bass output is boosted by feeding bass sounds from the front right and left, and center speakers to the subwoofer. "On": Bass output is boosted. "Off": Bass output is not boosted. <ul style="list-style-type: none"> This function is not automatically set even if AccuEQ Room Calibration is performed.

3. Distance

Set the distance from each speaker to the listening position.

Setting Item	Default Value	Setting Details
Front Left	12.0 ft/3.60 m	Specify the distance between each speaker and the listening position.
Center	12.0 ft/3.60 m	Specify the distance between each speaker and the listening position.
Front Right	12.0 ft/3.60 m	Specify the distance between each speaker and the listening position.
Height 1 Left	9.0 ft/2.70 m	Specify the distance between each speaker and the listening position. <ul style="list-style-type: none"> Depending on the use of the ZONE speakers, it may not be possible to select this setting.
Height 1 Right	9.0 ft/2.70 m	Specify the distance between each speaker and the listening position. <ul style="list-style-type: none"> Depending on the use of the ZONE speakers, it may not be possible to select this setting.
Height 2 Left	9.0 ft/2.70 m	Specify the distance between each speaker and the listening position. <ul style="list-style-type: none"> Depending on the use of the ZONE speakers, it may not be possible to select this setting.
Height 2 Right	9.0 ft/2.70 m	Specify the distance between each speaker and the listening position. <ul style="list-style-type: none"> Depending on the use of the ZONE speakers, it may not be possible to select this setting.
Surround Right	7.0 ft/2.10 m	Specify the distance between each speaker and the listening position.
Surr Back Right	7.0 ft/2.10 m	Specify the distance between each speaker and the listening position. <ul style="list-style-type: none"> Depending on the use of the ZONE speakers, it may not be possible to select this setting.
Surr Back Left	7.0 ft/2.10 m	Specify the distance between each speaker and the listening position. <ul style="list-style-type: none"> Depending on the use of the ZONE speakers, it may not be possible to select this setting.

Setting Item	Default Value	Setting Details
Surround Left	7.0 ft/2.10 m	Specify the distance between each speaker and the listening position.
Subwoofer	12.0 ft/3.60 m	Specify the distance between each speaker and the listening position.

- Default values vary depending on the regions.
- The unit of distance can be changed by pressing the MODE button on the remote controller. When using the unit "feet", the setting is available in increments of 0.1 ft from 0.1 ft to 30.0 ft. When using the unit "meter", the setting is available in increments of 0.03 m from 0.03 m to 9.00 m.

■ 4. Level Calibration

Adjust the volume level of each speaker.

Setting Item	Default Value	Setting Details
Front Left	0.0 dB	Select a value between "-12.0 dB" and "+12.0 dB" (in 0.5 dB increments). A test tone will be output each time you change the value. Select the desired level.
Center	0.0 dB	Select a value between "-12.0 dB" and "+12.0 dB" (in 0.5 dB increments). A test tone will be output each time you change the value. Select the desired level.
Front Right	0.0 dB	Select a value between "-12.0 dB" and "+12.0 dB" (in 0.5 dB increments). A test tone will be output each time you change the value. Select the desired level.
Height 1 Left	0.0 dB	Select a value between "-12.0 dB" and "+12.0 dB" (in 0.5 dB increments). A test tone will be output each time you change the value. Select the desired level. • Depending on the use of the ZONE speakers, it may not be possible to select this setting.
Height 1 Right	0.0 dB	Select a value between "-12.0 dB" and "+12.0 dB" (in 0.5 dB increments). A test tone will be output each time you change the value. Select the desired level. • Depending on the use of the ZONE speakers, it may not be possible to select this setting.

Setting Item	Default Value	Setting Details
Height 2 Left	0.0 dB	Select a value between "-12.0 dB" and "+12.0 dB" (in 0.5 dB increments). A test tone will be output each time you change the value. Select the desired level. • Depending on the use of the ZONE speakers, it may not be possible to select this setting.
Height 2 Right	0.0 dB	Select a value between "-12.0 dB" and "+12.0 dB" (in 0.5 dB increments). A test tone will be output each time you change the value. Select the desired level. • Depending on the use of the ZONE speakers, it may not be possible to select this setting.
Surround Right	0.0 dB	Select a value between "-12.0 dB" and "+12.0 dB" (in 0.5 dB increments). A test tone will be output each time you change the value. Select the desired level.
Surr Back Right	0.0 dB	Select a value between "-12.0 dB" and "+12.0 dB" (in 0.5 dB increments). A test tone will be output each time you change the value. Select the desired level. • Depending on the use of the ZONE speakers, it may not be possible to select this setting.
Surr Back Left	0.0 dB	Select a value between "-12.0 dB" and "+12.0 dB" (in 0.5 dB increments). A test tone will be output each time you change the value. Select the desired level. • Depending on the use of the ZONE speakers, it may not be possible to select this setting.
Surround Left	0.0 dB	Select a value between "-12.0 dB" and "+12.0 dB" (in 0.5 dB increments). A test tone will be output each time you change the value. Select the desired level.
Subwoofer	0.0 dB	Select a value between "-15.0 dB" and "+12.0 dB" (in 0.5 dB increments). A test tone will be output each time you change the value. Select the desired level.

■ 5. Dolby Enabled Speaker

Change the settings of Dolby Enabled Speakers.

Setting Item	Default Value	Setting Details
Dolby Enabled Speaker to Ceiling	6.0 ft/1.80 m	Set the distance between the Dolby Enabled Speaker and the ceiling. Select between "0.1 ft/0.03 m" and "15.0 ft/4.50 m" (0.1 ft/0.03 m units). • The unit of distance (ft/m) is displayed using the unit selected for the "Distance" setting.
AccuReflex	Off	You can enhance the reflection effect of Dolby Enabled Speakers from the ceiling. "Off": When this function is not used "On": When this function is used

- This setting can be selected when "Configuration" - "Height 1 Speaker"/"Height 2 Speaker" is set to "Dolby Speaker".

■ 6. Equalizer Settings

You can adjust the output volume of the range for each connected speaker. Adjust the volume of different sound ranges for each speaker. You can set three different equalizers in Preset 1 to 3. The number of frequencies that can be selected for each speaker is up to five bands for the Subwoofer and nine bands for the other speakers.

Setting Item	Default Value	Setting Details
Front	0.0 dB	After selecting the speaker frequency between "25 Hz" and "16 kHz" with the cursors ◀/▶, adjust the volume of that frequency between "-6.0 dB" and "+6.0 dB" with ▲/▼.
Center	0.0 dB	After selecting the speaker frequency between "25 Hz" and "16 kHz" with the cursors ◀/▶, adjust the volume of that frequency between "-6.0 dB" and "+6.0 dB" with ▲/▼.

Setting Item	Default Value	Setting Details
Height 1	0.0 dB	After selecting the speaker frequency between "25 Hz" and "16 kHz" with the cursors ◀/▶, adjust the volume of that frequency between "-6.0 dB" and "+6.0 dB" with ▲/▼. • Depending on the use of the ZONE speakers, it may not be possible to select this setting.
Height 2	0.0 dB	After selecting the speaker frequency between "25 Hz" and "16 kHz" with the cursors ◀/▶, adjust the volume of that frequency between "-6.0 dB" and "+6.0 dB" with ▲/▼. • Depending on the use of the ZONE speakers, it may not be possible to select this setting.
Surround	0.0 dB	After selecting the speaker frequency between "25 Hz" and "16 kHz" with the cursors ◀/▶, adjust the volume of that frequency between "-6.0 dB" and "+6.0 dB" with ▲/▼.
Surround Back	0.0 dB	After selecting the speaker frequency between "25 Hz" and "16 kHz" with the cursors ◀/▶, adjust the volume of that frequency between "-6.0 dB" and "+6.0 dB" with ▲/▼. • Depending on the use of the ZONE speakers, it may not be possible to select this setting.
Subwoofer	0.0 dB	After selecting the speaker frequency between "25 Hz" and "160 Hz" with the cursors ◀/▶, adjust the volume of that frequency between "-6.0 dB" and "+6.0 dB" with ▲/▼. • This cannot be selected if "Configuration" - "Subwoofer" is set to "No".

- Depending on the input source or listening mode setting, the desired effect may not be achieved.

7. THX Audio

Change the THX Audio settings.

Setting Item	Default Value	Setting Details
Back Speaker Spacing	>4.0 ft/>1.2 m	Select the distance between the surround back speakers from "<1.0 ft/<0.3 m", "1.0 - 4.0 ft/0.3 - 1.2 m", and ">4.0 ft/>1.2 m". <ul style="list-style-type: none"> The unit of distance (ft/m) is displayed using the unit selected for the "Distance" setting. Depending on the use of the ZONE speakers, it may not be possible to select this setting. If the item cannot be selected even though connection is correct, check if the setting in "Configuration" - "Speaker Channels" matches the number of connected channels.
THX Ultra / Select Subwoofer	No	Set whether a THX-certified subwoofer is connected or not. "Yes": When a THX-certified subwoofer is connected "No": When a THX-certified subwoofer is not connected <ul style="list-style-type: none"> The setting cannot be changed if "Configuration" - "Subwoofer" is set to "No"
BGC	Off	Correct an emphasized bass sound when listening to music near the wall or boundary of the room due to layout limitation of the listening room. The THX Select receivers can adjust the balance of bass sound. "On": When this function is used "Off": When this function is not used <ul style="list-style-type: none"> In the following cases, the setting cannot be changed: <ul style="list-style-type: none"> "Configuration" - "Subwoofer" is set to "No". "THX Ultra / Select Subwoofer" is set to "No".

Setting Item	Default Value	Setting Details
Loudness Plus	On	When this is set to "On", you can enjoy even subtle nuances of audio expression at low volume. This is only available when the THX listening mode is selected. THX Loudness Plus THX Loudness Plus is a new volume control technology mounted on THX Ultra and THX Select-certified receivers. With THX Loudness Plus, home theater audience can experience the rich details of surround sound at any volume level. If the volume is turned down below the reference level, elements of sound in a certain range are lost or the sound is perceived differently by the listener. THX Loudness Plus compensates for the tonal and spatial shifts that occur when the volume level is reduced, by intelligently adjusting the levels of the surround channels and their frequency response in the environment. This enables users to experience the true impact of soundtracks regardless of the volume setting. THX Loudness Plus is automatically applied when listening in any THX listening mode. In the newly developed THX Cinema, THX Music and THX Games modes, the optimum THX Loudness Plus setting is applied according to the type of content.

3. Audio Adjust

1. Multiplex/Mono

Change the settings of multiplex audio playback.

Setting Item	Default Value	Setting Details
Multiplex Input Channel	Main	Set the audio channel or language to be output when playing multiplex audio or multilingual broadcasts, etc. "Main": Main channel only "Sub": Sub channel only "Main/Sub": Main and sub channels are output at the same time. • For multiplex audio broadcasts, pressing the i button on the remote controller will display "1+1" on the main unit's display.
Mono Input Channel	Left + Right	Set the input channel to play 2-ch digital sources such as Dolby Digital, or 2-ch analog/PCM sources in the Mono listening mode. "Left": Left channel only "Right": Right channel only "Left + Right": Left and right channels
Mono Output Speaker	Center	Set the speaker to output monaural audio in the Mono listening mode. "Center": Audio is output from the center speaker. "Left/Right": Audio is output from the front L/R speakers. • If the item cannot be selected even though connection is correct, check if the setting in "2. Speaker" - "Configuration" - "Speaker Channels" matches the number of connected channels.

2. Dolby

Change the setting of when Dolby signals are input.

Setting Item	Default Value	Setting Details
Loudness Management	On	When playing Dolby TrueHD, enable the dialog normalization function which keeps the volume of dialog at a certain level. Note that when this setting is Off, the Late Night function that allows you to enjoy surround at low volumes is fixed to off when playing Dolby Digital Plus/Dolby TrueHD. "On": When this function is used "Off": When this function is not used

3. DTS

Change the setting of when DTS signals are input.

Setting Item	Default Value	Setting Details
DTS Auto Surround	On	When inputting DTS signals that include extended channel information, the optimum listening mode is automatically selected according to the extended information contained in the input signal and the speaker configuration of this unit when playing in the straight decoding listening mode. "On": When this function is used "Off": Audio is played using the same number of channels in the input signal according to the speaker configuration of this unit. • If this function is set to "Off", the ES Matrix and ES Discrete listening modes cannot be selected.

4. LFE Level

Set the low-frequency effect (LFE) level for Dolby Digital series, DTS series, Multichannel PCM, and DSD signals.

Setting Item	Default Value	Setting Details
LFE Level	0 dB	Select the low-frequency effect (LFE) level of each signal from "0dB" to "-∞dB". If the low-frequency effect sound is too strong, select "-20dB" or "-∞dB".

■ 5. Volume

Change the Volume settings.

Setting Item	Default Value	Setting Details
Volume Display	Absolute	Switch the volume display between the absolute value and relative value. The absolute value 82.0 is equivalent to the relative value 0.0dB. "Absolute": Absolute value such as "0.5" and "99.5" "Relative": Relative value such as "-81.5dB" and "+18.0dB" • If the absolute value is set to 82.0, "82.0Ref" appears on the display.
Mute Level	-∞dB	Set the volume lowered from the listening volume when muting is on. Select a value from "-∞dB", "-40dB" and "-20dB".
Maximum Volume	Off	Set the maximum value to prevent the volume from becoming too loud. Select a value from "Off", and "50" to "99". (When "Volume Display" is set to "Absolute")
Power On Volume	Last	Set the volume level of when the power is turned on. Select a value from "Last" (Volume level before entering standby mode), "Min", "0.5" to "99.5" and "Max". (When "Volume Display" is set to "Absolute") • You cannot set a higher value than that of "Maximum Volume".
Headphone Level	0.0 dB	Adjust the output level of headphones. Select a value between "-12.0 dB" and "+12.0 dB".

4. Source

■ 1. IntelliVolume

Adjust the volume level when there are differences in volume level among multiple devices connected to this unit. Select the input selector to make the setting.

Setting Item	Default Value	Setting Details
IntelliVolume	0.0 dB	Select a value between "-12.0 dB" and "+12.0 dB". Set a negative value if the volume of the target device is larger than the others and a positive value if smaller. To check the audio, play back the connected device. • This function does not work in Zone 2/Zone 3.

■ 2. Name Edit

Set an easy name for each input. The set name appears on the main unit's display. Select the input selector to make the setting.

Setting Item	Default Value	Setting Details
Name Edit	Input name	<ol style="list-style-type: none"> Select a character or symbol with the cursors, and press ENTER. Repeat this operation to input up to 10 characters. "A/a": Switches between upper and lower cases. (Pressing MODE on the remote controller also toggles between upper and lower cases) "←" "→": Moves the cursor in the arrow direction. "⊞": Removes a character on the left of the cursor. "␣": Enters a space. • Pressing CLEAR on the remote controller will remove all the input characters. After inputting, select "OK" with the cursors, and press ENTER. The input name will be saved.

- To name a preset radio station, press TUNER on the remote controller, select AM/FM, and select the preset number.

- This cannot be set if the "NET" or "BLUETOOTH" input is selected.

■ Audio Select

Select the priority for input selection when multiple audio sources are connected to one input selector, for example, connections to both the "BD/DVD" HDMI IN jack and the "BD/DVD" AUDIO IN jack. The setting can be made for each input selector button. Select the input selector to make the setting. Note that some of the default values cannot be changed.

Setting Item	Default Value	Setting Details
Audio Select	BD/DVD: HDMI CBL/SAT: HDMI GAME: HDMI STRM BOX: HDMI PC: HDMI AUX: HDMI CD: OPTICAL PHONO: Analog TV: OPTICAL	"ARC": When giving priority to the input signal from ARC-compatible TV. <ul style="list-style-type: none"> • This item can be selected only when "5. Hardware" - "HDMI" - "Audio Return Channel" is set to "Auto" and also the "TV" input is selected. "HDMI": When giving priority to the input signal from HDMI IN jacks <ul style="list-style-type: none"> • This item can be selected only when the input to be set is assigned to the HDMI jack in the "1. Input/Output Assign" - "HDMI Input" setting. "COAXIAL": When giving priority to the input signal from DIGITAL IN COAXIAL jacks <ul style="list-style-type: none"> • This item can be selected only when the input to be set is assigned to the COAXIAL jack in the "1. Input/Output Assign" - "Digital Audio Input" setting. "OPTICAL": When giving priority to the input signal from DIGITAL IN OPTICAL jacks <ul style="list-style-type: none"> • This item can be selected only when the input to be set is assigned to the OPTICAL jack in the "1. Input/Output Assign" - "Digital Audio Input" setting. "Analog": To always output analog audio regardless of input signal <ul style="list-style-type: none"> • This item can be selected only when the input to be set is assigned to the AUDIO IN jack in the "1. Input/Output Assign" - "Analog Audio Input" setting.

Setting Item	Default Value	Setting Details
PCM Fixed Mode	Off	Select whether to fix input signals to PCM (except multi-channel PCM) when you select "HDMI", "COAXIAL", or "OPTICAL" in the "Audio Select" setting. Set this item to "On" if noise is produced or truncation occurs at the beginning of a track when playing PCM sources. Select "Off" normally. <ul style="list-style-type: none"> • Each time the "Audio Select" setting is changed, the setting is restored to "Off".

- The setting cannot be changed when "TUNER", "NET", or "BLUETOOTH" input is selected.

■ Video Select

When "TUNER", "NET", or "BLUETOOTH" input is selected, you can set the input from which video is displayed on the TV.

Setting Item	Default Value	Setting Details
Video Select	Last	"Last": Select the video input played last. "BD/DVD", "CBL/SAT", "GAME", "STRM BOX", "PC", "AUX", "CD", "TV", "PHONO": Play the video of each input. <ul style="list-style-type: none"> • This setting is effective for an input selector assigned in "1. Input/Output Assign" - "HDMI Input" and "Video Input".

- If the OSD language is set to Chinese, you can select this setting only when "TUNER" is selected as input. (European, Australian and Asian models)

5. Hardware

1. HDMI

Change the settings of the HDMI function.

Setting Item	Default Value	Setting Details
HDMI CEC	Off	<p>Setting this to "On" enables the input selection link and other link functions with HDMI-connected CEC-compatible device.</p> <p>"On": When this function is used "Off": When this function is not used</p> <p>When this setting is changed, turn off and then on again the power of all connected devices.</p> <ul style="list-style-type: none"> Depending on the TV to use, a link setting may be required on the TV. This function is effective only when the device is connected to the HDMI OUT MAIN terminal. Setting this to "On" and closing the operation screen will display the name of the connected CEC-compatible device and "CEC On" on the main unit's display. When this is set to "On", the power consumption in standby mode may increase. (Depending on the TV status, the unit will enter the normal standby mode.) If you operate the MASTER VOLUME dial on the main unit when this setting is "On" and audio is output from the TV speakers, audio will be output also from the speakers connected to this unit. To output audio from only either of them, change the setting of this unit or TV, or reduce the volume of this unit. If abnormal behavior is observed when this is set to "On", set it to "Off". If a connected device is not CEC-compatible, or if you are not sure whether it is compatible, set it to "Off".

Setting Item	Default Value	Setting Details
HDMI Standby Through	Off	<p>When this is set to anything other than "Off", you can play the video and audio of an HDMI-connected player on the TV even if the unit is in standby mode. Also, only "Auto" and "Auto(Eco)" can be selected if "HDMI CEC" is set to "On". If you select anything else, set "HDMI CEC" to "Off".</p> <ul style="list-style-type: none"> The power consumption in standby mode will increase if it is set to anything other than "Off". <p>"BD/DVD", "CBL/SAT", "GAME", "STRM BOX", "PC", "AUX", "CD", "TV", "PHONO": For example, if you select "BD/DVD", you can play the device connected to the "BD/DVD" jack on the TV even if the unit is in standby mode. Select this setting if you have decided which player to use with this function.</p> <p>"Last": You can play on the TV the video and audio of the input selected immediately before the unit is switched to standby. When "Last" is selected, you can switch the input of the unit using the remote controller or the Onkyo Remote app even in the standby mode.</p> <p>"Auto", "Auto (Eco)": Select either of the settings if the connected player conforms to the CEC standard. You can play the video and audio of the player on the TV using the CEC link function, irrespective of what input is selected immediately before the unit is switched to standby.</p> <ul style="list-style-type: none"> To play a non-CEC compliant player on the TV, turn the unit on and switch the input. When using a CEC-compliant TV, you can reduce the power consumption in standby mode by selecting "Auto (Eco)".

Setting Item	Default Value	Setting Details
Audio TV Out	Off	<p>You can enjoy audio through the speakers of the TV while this unit is on.</p> <p>"On": When this function is used "Off": When this function is not used</p> <ul style="list-style-type: none"> This setting is fixed to "Auto" if you set "1. Input/Output Assign" - "TV Out/OSD" - "HDMI Out" or "Other" - "HDMI Out" in the "Quick Menu" to "MAIN" or "MAIN+SUB" and set "HDMI CEC" to "On". If you change this setting, set "HDMI CEC" to "Off". Listening mode cannot be changed while "Audio TV Out" is set to "On" and audio is being output from the TV. Depending on your TV or input signal of the connected device, audio may not be output from the TV even if this is set to "On". In such a case, audio is output from the speakers of the unit. Audio is output from this unit if you operate the MASTER VOLUME dial on this unit when audio that is input to this unit is output from your TV speakers. If you do not want to output audio, change the setting of this unit or TV, or reduce the volume of this unit.
Audio Return Channel	Auto (*)	<p>You can enjoy the sound of the HDMI-connected ARC-compatible TV through the speakers connected to the unit.</p> <p>*To use this function, set "HDMI CEC" to "On" beforehand.</p> <p>"Auto": When enjoying the TV sound through the speakers of this unit "Off": When not using the ARC function</p>
Auto Lip Sync	On	<p>This setting automatically corrects desynchronization between the video and audio signals based on the information from the HDMI Lip Sync-compatible TV.</p> <p>"On": When enabling the automatic correction function "Off": When not using the automatic correction function</p>

2. Network

Change the settings of the Network function.

- When LAN is configured with a DHCP, set "DHCP" to "Enable" to configure the setting automatically. ("Enable" is set by default) To assign fixed IP addresses to each components, you must set "DHCP" to "Disable", assign an address to this unit in the "IP Address" setting, and set information related to your LAN, such as Subnet Mask and Gateway.

Setting Item	Default Value	Setting Details
Wi-Fi	Off(Wired)	<p>Connect the unit to the network via a wireless LAN router.</p> <p>"On": Wireless LAN connection "Off(Wired)": Wired LAN connection</p> <ul style="list-style-type: none"> When switching between "On" and "Off(Wired)", stop the Network service. Also, when group playback is in process, cancel the group playback once, and then switch the setting.
Wi-Fi Setup	-	Configure wireless LAN settings by pressing ENTER with "Start" displayed.
Wi-Fi Status	-	<p>The information of the connected access point is displayed.</p> <p>"SSID": SSID of the connected access point. "Signal": Signal strength of the connected access point. "Status": Status of the connected access point.</p>
MAC Address	-	<p>Check the MAC address of this unit.</p> <p>This value is specific to the component and cannot be changed.</p>
DHCP	Enable	<p>"Enable": Auto configuration by DHCP "Disable": Manual configuration without DHCP</p> <ul style="list-style-type: none"> If you select "Disable", set "IP Address", "Subnet Mask", "Gateway", and "DNS Server" manually.
IP Address	0.0.0.0	Displays/Sets the IP address.
Subnet Mask	0.0.0.0	Displays/Sets the subnet mask.
Gateway	0.0.0.0	Displays/Sets the gateway.
DNS Server	0.0.0.0	Displays/Sets the primary DNS server.
Proxy URL	-	Displays/Sets the proxy server URL.

Setting Item	Default Value	Setting Details
Proxy Port	8080	Displays/Sets the proxy server port number when you input "Proxy URL".
Friendly Name	Onkyo TX-RZ830 XXXXXX	<p>Change the model name of this unit which is displayed on the device connected to the network to an easily recognized name.</p> <ol style="list-style-type: none"> Press ENTER to display the Edit screen. Select a character or symbol with the cursors, and press ENTER. Repeat this operation to input up to 31 characters. "A/a": Switches between upper and lower cases. (Pressing MODE on the remote controller also toggles between upper and lower cases) "←" "→": Moves the cursor in the arrow direction. "⊞": Removes a character on the left of the cursor. "␣": Enters a space. <ul style="list-style-type: none"> Pressing CLEAR on the remote controller will remove all the input characters. After inputting, select "OK" with the cursors, and press ENTER. The input name will be saved.

Setting Item	Default Value	Setting Details
AirPlay Password		<p>You can set a password of up to 31 digits so that only registered users can use AirPlay®.</p> <ol style="list-style-type: none"> Press ENTER to display the Edit screen. Select a character or symbol with the cursors, and press ENTER. Repeat this operation to input up to 31 characters. "A/a": Switches between upper and lower cases. (Pressing MODE on the remote controller also toggles between upper and lower cases) "←" "→": Moves the cursor in the arrow direction. "⊞": Removes a character on the left of the cursor. "␣": Enters a space. <ul style="list-style-type: none"> To select whether to mask the password with "*" or display it in plain text, press MEMORY on the remote controller. Pressing CLEAR on the remote controller will remove all the input characters. After inputting, select "OK" with the cursors, and press ENTER. The input password will be saved.
Usage Data	No	<p>To improve the quality of our products and services, we may collect information about your usage via a network. Select "Yes" if you agree to our collecting this information. Select "No" if you do not want us to collect this information.</p> <ul style="list-style-type: none"> You can set this after confirming the Privacy Policy. When you select "Usage Data" and press ENTER, the Privacy Policy is displayed. (The same screen is displayed only once while setting the network connection.) If you agree to the collection of the information, this setting also becomes "Yes". Note that if you select "No" for this setting after you agree to the Privacy Policy, the information will not be collected.
Network Check	-	You can check the network connection. Press ENTER when "Start" is displayed.

- Wait for a while if "Network" cannot be selected. It can be selected when the network function is activated.

■ 3. Bluetooth

Change the settings for the Bluetooth function.

Setting Item	Default Value	Setting Details
Bluetooth	On	Select whether or not to use the BLUETOOTH function. "On": Enables connection with a BLUETOOTH-enabled device by using the BLUETOOTH function. Select "On" also when making various BLUETOOTH settings. "Off": When not using the BLUETOOTH function
Auto Input Change	On	The input of the unit can be automatically switched to "BLUETOOTH" when connection is made from a BLUETOOTH-enabled device to the unit. "On": The input is automatically set to "BLUETOOTH" when a BLUETOOTH-enabled device is connected. "Off": The function is disabled. • If the input is not switched automatically, set this to "Off", and change the input manually.
Auto Reconnect	On	This function automatically reconnects to the BLUETOOTH-enabled device connected last when you change the input to "BLUETOOTH". "On": When this function is used "Off": When this function is not used • This may not work with some BLUETOOTH-enabled devices.
Pairing Information	-	You can initialize the pairing information stored on this unit. Pressing ENTER when "Clear" is displayed initializes the pairing information stored on this unit. • This function does not initialize the pairing information on the BLUETOOTH-enabled device. When pairing the unit again with the device, be sure to clear the pairing information on the BLUETOOTH-enabled device beforehand. For information on how to clear the pairing information, refer to the instruction manual of the BLUETOOTH-enabled device.

Setting Item	Default Value	Setting Details
Device	-	Displays the name of the BLUETOOTH-enabled device connected to the unit. • The name is not displayed when "Status" is "Ready" and "Pairing".
Status	-	Displays the status of the BLUETOOTH-enabled device connected to the unit. "Ready": Not paired "Pairing": Paired "Connected": Successfully connected

- Wait for a while if "Bluetooth" cannot be selected. It can be selected when the BLUETOOTH function is activated.

■ 4. Power Management

Change the settings for the power-save function.

Setting Item	Default Value	Setting Details
Sleep Timer	Off	You can allow the unit to enter standby automatically when the specified time elapses. Select a value from "30 minutes", "60 minutes" and "90 minutes". "Off": The unit does not automatically enter standby mode.
Auto Standby	On/Off	This setting allows the unit to enter standby mode automatically after 20 minutes of inactivity without any video or audio input. (When "USB Power Out at Standby" or "Network Standby" is enabled, the unit enters the HYBRID STANDBY mode which minimizes the increase in power consumption.) "On": The unit automatically enters standby mode ("AUTO STBY" lights up). "Off": The unit does not automatically enter standby mode. • "Auto Standby" is displayed on the main unit's display and TV screen 30 seconds before entering standby mode. • "Auto Standby" does not work when Zone 2/ Zone 3 is active. • Default values vary depending on the regions.

Setting Item	Default Value	Setting Details
Auto Standby in HDMI Standby Through	Off	Enable or disable "Auto Standby" while "HDMI Standby Through" is on. "On": The setting is enabled. "Off": The setting is disabled. • This setting cannot be set to "On" if "Auto Standby" and "HDMI Standby Through" are set to "Off".
USB Power Out at Standby	Off	When this function is set to "On", electricity can be supplied to the device connected to the USB port even if this unit is in standby mode . • While using this function, power consumption increases in standby mode, however, the increase in power consumption is minimized by automatically entering the HYBRID STANDBY mode where only the essential circuits are operating.
Network Standby	On	When this function is set to "On", you can turn on the power of the unit via network using an application such as Onkyo Remote that can control this unit. • When "Network Standby" is used, power consumption increases in standby mode, however, the increase in power consumption is minimized by automatically entering the HYBRID STANDBY mode where only the essential circuits are operating. • When connection to the network is lost, "Network Standby" may be disabled to reduce power consumption. In such a case, turn the unit on by using the power button on the remote controller or main unit.

Setting Item	Default Value	Setting Details
Bluetooth Wakeup	Off	This function wakes up the unit on standby by connecting a BLUETOOTH-enabled device. "On": When this function is used "Off": When this function is not used • When this is set to "On", power consumption increases in standby mode, however, the increase in power consumption is minimized by automatically entering the HYBRID STANDBY mode where only the essential circuits are operating. • This setting is fixed to "Off" if "Bluetooth" - "Auto Input Change" is set to "Off".

- Wait for a while if "Network Standby" and "Bluetooth Wakeup" cannot be selected. It can be selected when the network function is activated.

■ 5. 12V Trigger

Set when outputting the control signal (maximum 12 V/100 mA) through the 12V TRIGGER OUT jack. You can enable power link operation when you connect the unit and the external devices equipped with 12V trigger input jack.

Setting Item	Default Value	Setting Details
Zone	Main	Set which zone to output the 12V trigger when playing. If you select "All", then the 12V trigger is output to all zones that are playing.

6. Multi Zone

1. Zone 2

Change the settings for Zone 2.

Setting Item	Default Value	Setting Details
Output Level	Fixed	Select whether to adjust the volume on the premain amplifier in the separate room or on this unit when outputting to Zone 2. "Fixed": Adjust on the pre-main amplifier in the separate room "Variable": Adjust on this unit
Maximum Volume	Off	Set the maximum value for Zone 2 to prevent the volume from becoming too loud. Select a value from "Off", and "50" to "99". (When "3. Audio Adjust" - "Volume" - "Volume Display" is set to "Absolute")
Power On Volume	Last	Set the Zone 2 volume level of when the unit is turned on. Select a value from "Last" (Volume level when the unit was turned off), "Min", "0.5" to "99.5" and "Max". (When "3. Audio Adjust" - "Volume" - "Volume Display" is set to "Absolute") • You cannot set a higher value than that of "Maximum Volume".

2. Zone 3

Change the settings for Zone 3.

Setting Item	Default Value	Setting Details
Output Level	Fixed	Select whether to adjust the volume on the premain amplifier in the separate room or on this unit when outputting to Zone 3. "Fixed": Adjust on the pre-main amplifier in the separate room "Variable": Adjust on this unit • When "2. Speaker" - "Configuration" - "Zone Speaker" is set to "Zone 2/Zone 3", this setting is fixed to "Variable".

Setting Item	Default Value	Setting Details
Maximum Volume	Off	Set the maximum value for Zone 3 to prevent the volume from becoming too loud. Select a value from "Off", and "50" to "99". (When "3. Audio Adjust" - "Volume" - "Volume Display" is set to "Absolute")
Power On Volume	Last	Set the Zone 3 volume level of when the unit is turned on. Select a value from "Last" (Volume level when the unit was turned off), "Min", "0.5" to "99.5" and "Max". (When "3. Audio Adjust" - "Volume" - "Volume Display" is set to "Absolute") • You cannot set a higher value than that of "Maximum Volume".

3. Remote Play Zone

Change the settings for remote play.

Setting Item	Default Value	Setting Details
Remote Play Zone	Auto	When playing with AirPlay or Spotify Connect, or when using the Music Server function to play remotely from your PC, you can set whether to play in the main room (where this unit is located) or in a separate room (ZONE 2/ZONE 3). "Auto": When the main room input is NET, music is played in the main room. When the separate room input is NET and the main room input is other than NET, then the music is played in the separate room. "Main", "Zone 2", "Zone 3": Select when limiting the play zone to a particular room. For example, when playing only in the separate room, select "Zone 2" or "Zone 3". • This function may not work if playback is already proceeding with the same network function.

7. Miscellaneous

■ 1. Tuner

Change the frequency step for the tuner.

Setting Item	Default Value	Setting Details
AM/FM Frequency Step (North American models)	10 kHz/0.2 MHz	Select a frequency step to suit your residential area. Select "10 kHz/0.2 MHz" or "9 kHz/0.05 MHz". • When this setting is changed, all radio presets are deleted.
AM Frequency Step (European, Australian and Asian models)	9 kHz	Select a frequency step to suit your residential area. Select "10 kHz" or "9 kHz". • When this setting is changed, all radio presets are deleted.

2. Remote ID

Change the remote controller ID.

Setting Item	Default Value	Setting Details
Remote ID	1	If multiple ONKYO products are installed in the same room, select the ID for the remote control used with this unit from "1", "2" and "3" to prevent interference between the unit and other ONKYO products. After changing the ID on the main unit, set the same ID on the remote controller as the main unit with the following procedure. While pressing and holding the MODE button, press the following buttons for approx. 3 seconds. • To change the remote controller ID to "1": ◀◀ (The remote indicator blinks once.) • To change the remote controller ID to "2": ▶▶ / ■■ (The remote indicator blinks twice.) • To change the remote controller ID to "3": ▶▶▶ (The remote indicator blinks three times.)

■ 3. Firmware Update

Change the settings for Firmware Update.

Setting Item	Default Value	Setting Details
Update Notice	Enable	Availability of a firmware update is notified via network. "Enable": Notify updates "Disable": Do not notify updates
Version	-	The current firmware version is displayed.
Update via NET	-	Press ENTER to select when updating the firmware via network. • This setting cannot be selected if you do not have Internet access or there is no updatable firmware.
Update via USB	-	Press ENTER to select when updating the firmware via USB. • This setting cannot be selected if a USB storage device is not connected or there is no updatable firmware in the USB storage device.

- Wait for a while if "Firmware Update" cannot be selected. It can be selected when the network function is activated.

■ 4. Initial Setup

Make the initial setup from the setup menu.

- Wait for a while if "Initial Setup" cannot be selected. It can be selected when the network function is activated.

■ 5. Lock

Lock the Setup menu so that the settings cannot be changed.

Setting Item	Default Value	Setting Details
Setup Parameter	Unlocked	Lock the Setup menu so that the settings cannot be changed. "Locked": The menu is locked. "Unlocked": The menu is unlocked.

Quick Menu

Menu operations

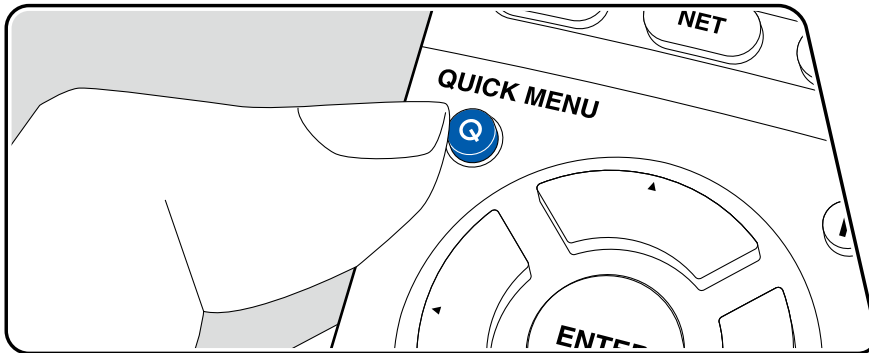

You can quickly adjust the settings you frequently use, such as tone adjustments, etc.

You can make the settings on the TV screen during playback. Press Q on the remote controller to display the Quick Menu.

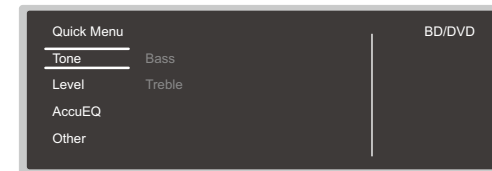

Select the item with the cursors ▲/▼ of the remote controller, and press ENTER to confirm your selection.

Use the cursors to change the settings.

- To return to the previous screen, press ↵.
- To exit the settings, press Q.

■ Tone

Bass: Enhances or moderates the low-tone range of the speakers.

Treble: Enhances or moderates the high-tone range of the speakers.

- It cannot be set if the listening mode is Pure Audio, Direct or THX.

■ Level

Center: Adjust the speaker level of the center speaker while listening to the sound.

Subwoofer: Adjust the speaker level of the subwoofer while listening to the sound.

- If you set the unit to the standby mode, the adjustments you made will be restored to the previous statuses.

■ AccuEQ

AccuEQ Room Calibration: Enable or disable the equalizer function that corrects for sound distortion caused by the acoustic environment of the room. To enable this setting, normally select "On (All Ch)", and to disable only the front speakers, select "On (ex. L/R)". The setting can be set for each input.

Equalizer: Select "Preset 1" to "Preset 3" configured in "2. Speaker" - "Equalizer Settings" in the Setup menu. When this is set to "Off", the same sound field setting is applied to all ranges.

EQ for Standing Wave : Setting this "On" will control the effect of the standing wave generated by the sound wave reflected by wall or similar interfering with the original sound wave.

Re-EQ, Re-EQ(THX): Adjusts the soundtrack with the enhanced high range so that it suits a home theater.

In Re-EQ, the following listening modes can be used: Dolby Audio - DD, Dolby Audio - DD+, Dolby Audio - DSUR, Dolby Audio - TrueHD, Multichannel, DTS, DTS-ES, DTS 96/24, DTS-HD High Resolution Audio, DTS-HD Master Audio, DTS Neural:X, DTS Express and DSD.

In Re-EQ(THX), the following listening modes can be used: THX Cinema and THX Select Cinema.

- It cannot be set if the listening mode is Pure Audio or Direct.

■ Other

A/V Sync: If the video is behind the audio, you can delay the audio to offset the gap. The setting can be set for each input.

- It cannot be set if the listening mode is Pure Audio or Direct.

Music Optimizer: Improve the quality of the compressed audio. Playback sound of lossy compressed files such as MP3 will be improved. The setting can be set for each input. This works in signals whose sampling frequencies are 48 kHz or less. The setting is not effective in the bitstream signals.

- It cannot be set if the listening mode is Pure Audio or Direct.

Late Night: Enable small sounds to be easily heard in detail. It is useful when you need to reduce the volume while watching a movie late night. You can enjoy the effect only when playing the Dolby series and DTS series input signals.

- This function cannot be used in the following cases.

- When playing Dolby Digital Plus or Dolby TrueHD with "Loudness Management" set to "Off"
- When the input signal is DTS:X, and "Dialog Control" is not 0 dB

Center Spread: Adjust the width of the sound field of the front channel when playing in the Dolby Audio - DSUR listening mode. To spread the width of the sound field to the right and left, set to "On". To concentrate the sound in the center, set to "Off".

- Depending on the speaker settings, "Off" is applied.

Dialog Control: You can increase the volume of dialog portion of the audio up to 6 dB by 1 dB step so that you can hear the dialog easily in noisy atmosphere.

- This cannot be set for content other than DTS:X.
- Depending on the content, this function may not be selected.

HDMI Out: Select the HDMI OUT jack to output video signals from "MAIN", "SUB", and "MAIN+SUB".

Web Setup

Menu operations

You can make the settings for the network function of this unit using an Internet browser on a PC, smartphone, etc.

1. Press  on the remote controller to display the Setup menu.
2. Select "5. Hardware" - "Network" with the cursors, and then take a note of the IP address displayed in "IP Address".
3. Start the Internet browser on your PC, smartphone, etc. and enter the IP address of this unit in the URL field.
4. Information for the unit (Web Setup screen) is displayed in the Internet browser.

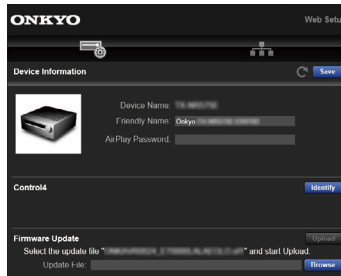

5. After changing the settings, select "Save" to save the settings.

Device Information

You can change the Friendly Name, set an AirPlay Password, etc.

Control4: Register this unit if you are using a Control4 system.

Firmware Update: Select the firmware file you have downloaded to your PC so you can update this unit.

Network Setting

Status: You can see information for the network such as the MAC address and IP address of this unit.

Network Connection: You can select a network connection method. If you select "Wireless", select an access point from "Wi-Fi Setup" to connect.

DHCP: You can change DHCP settings. If you select "Off", set "IP Address", "Subnet Mask", "Gateway" and "DNS Server" manually.

Proxy: Display and set the URL for the proxy server.

Firmware Update

Updating Function on This Unit

This unit has a function to update the firmware (system software) via network or USB port. This function can improve various operations and add various functions.

- For the latest information on updates, visit the Onkyo website. If there is no update available, updating the firmware of this unit is not necessary.
- Before updating, make sure that the speaker setup microphone is not connected.
- While updating the firmware, do not do the following:
 - Disconnecting and reconnecting cables, USB storage device, speaker setup microphone or headphones, or performing operations on the unit such as turning the power off
 - Accessing this unit from a PC or smartphone using their applications
- The update may take approx. 20 minutes to complete via network or via USB port. Existing settings are guaranteed in either updating method.

When this unit is connected to the network, notifications of firmware updates may be displayed. To update the firmware, select "Update Now" with the cursors on the remote controller, and press the ENTER button. The unit automatically enters standby mode after "Completed!" is displayed, and the update is completed.

Disclaimer: The program and accompanying online documentation are furnished to you for use at your own risk.

Onkyo will not be liable and you will have no remedy for damages for any claim of any kind whatsoever concerning your use of the program or the accompanying online documentation, regardless of legal theory, and whether arising in tort or contract.

In no event will Onkyo be liable to you or any third party for any special, indirect, incidental, or consequential damages of any kind, including, but not limited to, compensation, reimbursement or damages on account of the loss of present or prospective profits, loss of data, or for any other reason whatsoever.

□ Updating the Firmware via Network (→[p152](#))

Updating the Firmware via Network

- Check that the unit is turned on, and the connection to the Internet is secured.
- Turn off the controller components (PC etc.) connected to the network.
- Stop any playing Internet radio, USB storage device, or server content.
- If the multi-zone function is active, turn it off.
- If "HDMI CEC" is set to "On", set it to "Off".
 - Press . Next, select "5. Hardware" - "HDMI" and press ENTER, then select "HDMI CEC" and select "Off".
 - * The descriptions may differ from the actual on-screen displays, however, operations and functions are the same.

Update

1. Press .

The Setup menu is displayed on the TV screen.

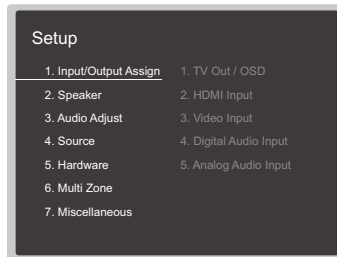

2. Select "7. Miscellaneous" - "Firmware Update" - "Update via NET" with the cursors in order, then press ENTER.

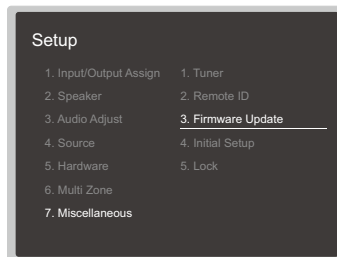

- If "Firmware Update" is grayed out and cannot be selected, wait for a while until it starts up.
 - If there is no updatable firmware, "Update via NET" cannot be selected.
3. Press ENTER with "Update" selected, and start update.
 - During the update, the TV screen may go black depending on the program to be updated. In such a case, check the progress on the display of the unit. The TV screen will remain black until the update is completed and the power is turned on again.
 - When "Completed!" is displayed, the update is complete.
 4. Press ON/STANDBY on the main unit to turn the unit into standby mode. The process is completed, and your firmware is updated to the latest version.
 - Do not use on the remote controller.

If an Error Message is Displayed

If an error occurs, "*-* * Error!" is displayed on the display of the unit. ("*" represents an alphanumeric character.) Refer to the following descriptions and check.

Error Code

- *-01, *-10:
LAN cable not found. Connect the LAN cable properly.
- *-02, *-03, *-04, *-05, *-06, *-11, *-13, *-14, *-16, *-17, *-18, *-20, *-21:

Internet connection error. Check the following:

- Whether the router is turned on
 - Whether this unit and the router are connected via the network
- Unplug and plug the power cords of this unit and the router. This may solve the problem. If you are still unable to connect to the Internet, the DNS server or proxy server may be temporarily down. Check the server operation status with your Internet service provider.

- Others:
After removing the power plug once, insert it to the outlet, and then start the operation from the beginning.

□ **Updating via USB (→[p154](#))**

Updating via USB

- Prepare a 128MB or larger USB storage device. The format of USB storage devices supports FAT16 or FAT32 file system format.
 - Media inserted into a USB card reader may not be used for this function.
 - USB storage devices equipped with the security function are not supported.
 - USB hubs and USB devices equipped with the hub function are not supported. Do not connect these devices to the unit.
- Delete any data stored on the USB storage device.
- Turn off control devices (PC etc.) connected to the network.
- Stop an Internet radio, USB storage device, or server content being played.
- If the multi-zone function is active, turn it off.
- If "HDMI CEC" is set to "On", set it to "Off".
 - Press . Next, select "5. Hardware" - "HDMI" and press ENTER, then select "HDMI CEC" and select "Off".
 - * Depending on the USB storage device or its content, long time may be required for loading, the content may not be loaded correctly, or power may not be supplied correctly.
 - * Onkyo will not be liable whatsoever for any loss or damage of data, or storage failure arising from the use of the USB storage device. Please note this in advance.
 - * The descriptions may differ from the actual on-screen displays, however, operations and functions are the same.

Update

1. Connect the USB storage device to your PC.
2. Download the firmware file from the Onkyo website to your PC and unzip. Firmware files are named as below.
 ONKAVR****_*****.zip
 Unzip the file on your PC. The number of unzipped files and folders varies depending on the model.
3. Copy all unzipped files and folders to the root folder of the USB storage device.
 - Make sure to copy the unzipped files.
4. Connect the USB storage device to the USB port of this unit.
 - If an AC adapter is supplied with the USB storage device, connect the AC adapter, and use it with a household outlet.
 - If the USB storage device has been partitioned, each section will be treated

- as an independent device.
 - 5. Press .
- The Setup menu is displayed on the TV screen.

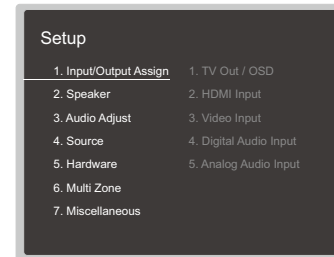

6. Select "7. Miscellaneous" - "Firmware Update" - "Update via USB" with the cursors in order, then press ENTER.

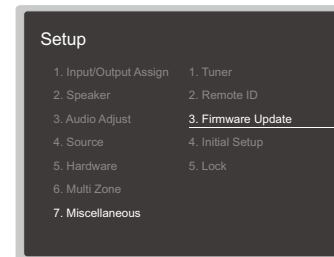

- If "Firmware Update" is grayed out and cannot be selected, wait for a while until it starts up.
 - If there is no updatable firmware, "Update via USB" cannot be selected.
7. Press ENTER with "Update" selected, and start update.
 - During the update, the TV screen may go black depending on the program to be updated. In such a case, check the progress on the display of the unit. The TV screen will remain black until the update is completed and the power is turned on again.
 - During the update, do not turn the power off, or disconnect or reconnect the USB storage device.

- When "Completed!" is displayed, the update is complete.
8. Disconnect the USB storage device from the unit.
 9. Press \odot ON/STANDBY on the main unit to turn the unit into standby mode.
The process is completed, and your firmware is updated to the latest version.
 - Do not use \odot on the remote controller.

If an Error Message is Displayed

If an error occurs, "*-* Error!" is displayed on the display of the unit. ("*" represents an alphanumeric character.) Refer to the following descriptions and check.

Error Code

- *-01, *-10:
The USB storage device cannot be recognized. Check if the USB storage device or USB cable is securely inserted to the USB port of the unit.
Connect the USB storage device to an external power source if it has its own power supply.
- *-05, *-13, *-20, *-21:
The firmware file is not present in the root folder of the USB storage device, or the firmware file is for another model. Retry from the download of the firmware file.
- Others:
After removing the power plug once, insert it to the outlet, and then start the operation from the beginning.

Initial Setup with Auto Start-up Wizard

Operations

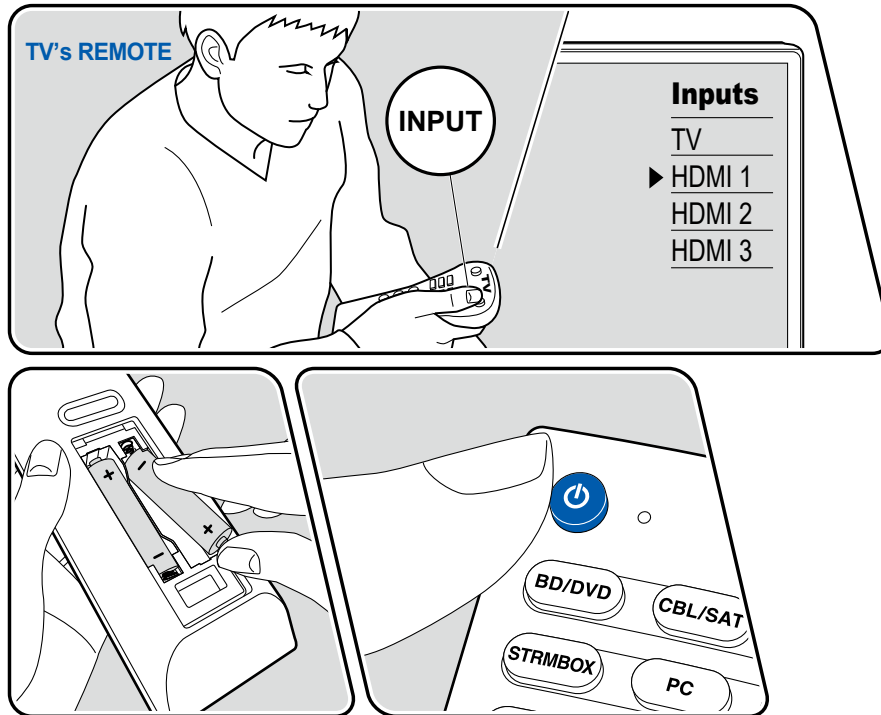

When you turn the unit on for the first time after purchase, the Initial Setup screen is automatically displayed on the TV to allow you to make settings required for startup using simple operations following on-screen guidance.

1. Switch the input of the TV to the input connected to the unit.
2. Put batteries into the remote controller of this unit.
3. Press **⏻** on the remote controller to turn the unit on.
4. Select the item with the cursors of the remote controller, and press **ENTER** to confirm your selection. To return to the previous screen, press **⏪**.

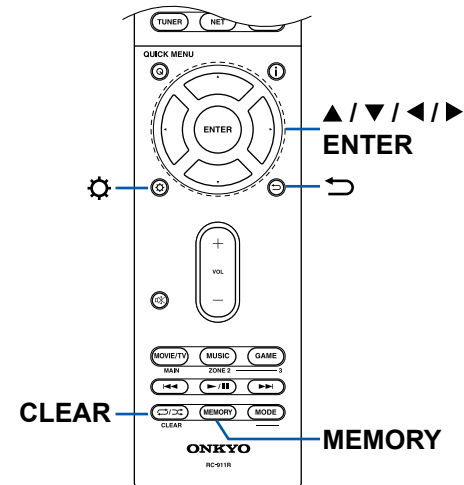

- If you have terminated the Initial Setup halfway, turn this unit to standby mode. Then turning the power on again can display the Initial Setup again. The Initial Setup appears on the screen each time the power is turned on unless the Initial Set up is completed or "Never Show Again" is selected on the first screen.
- To perform the Initial Setup again after the setting is completed, press , select "7. Miscellaneous" - "Initial Setup", and press ENTER.

■ 1. Speaker Setup

Select the connected speaker configuration.

Note that the image on the screen changes each time you select the number of channels in "Speaker Channels".

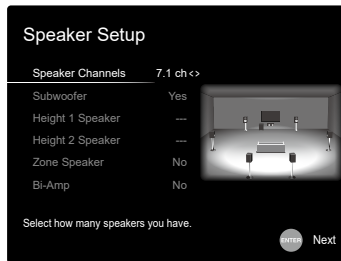

■ 2. AccuEQ Room Calibration

Place the supplied speaker setup microphone at the listening position. The unit automatically measures the test tones output from each speaker, and sets the optimum volume level for each speaker, the crossover frequencies, and the distance from the listening position. This also reduces the effect of the standing wave in accordance with the viewing environment and automatically adjusts the equalizers for the speakers, and enables correction of sound distortion caused by the acoustic environment of the room.

- It takes between 3 and 12 minutes for calibration to be completed. Each speaker outputs the test tone at high volume during measurement, so be careful of your surroundings. Also, keep the room as quiet as possible during measurement.
- If you connect a subwoofer, check the power and volume of the subwoofer. Set the subwoofer volume to more than half.

- If the power of this unit suddenly turns off, the wires in the speaker cables have touched the rear panel or other wires, and the protection circuit is working. Twist the wires again securely, and make sure they do not stick out of the speaker terminals when connecting.
- When using THX certified speakers, THX recommends that the crossover frequency is set to "80Hz(THX)". Also, THX recommends that each speaker setting is manually adjusted according to the specific characteristics of each room.

1. Place the supplied speaker setup microphone at the listening position, and connect it to the SETUP MIC jack on the main unit.

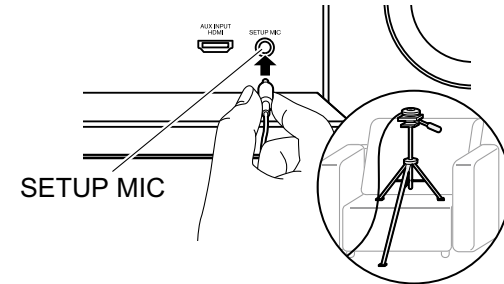

When placing the speaker setup microphone on a tripod, refer to the illustration.

2. Select "Next", and press ENTER. Then, test tones are output from each speaker, and the connected speakers and the noise in the surrounding environment are automatically measured.
3. The measurement results in step 2 are displayed. If there is no problem in the detection result of the speaker, select "Next" and press ENTER to output the test tone again to automatically set the settings such as volume level, crossover frequency, etc., to their optimum. (The test tone is automatically output when 10 seconds has elapsed without any operation.)
 - When an error message is displayed or when the connected speakers cannot be detected, perform re-measurement by selecting "Retry" and pressing ENTER.
 - When it cannot be resolved by performing the re-measurement, confirm if the speakers are connected correctly. If there is any problem with the speaker connection, perform the connection after disconnecting the power cord.

4. Once the measurement is completed, it is possible to perform the measurement in 2 additional listening positions. To perform the measurement, select "Next" and press ENTER, then follow the instructions. To not perform the measurement, select "Finish (Calculate)" and press ENTER.
5. Disconnect the speaker setup microphone.

■ 3. Multi Zone Sound Check

Output test tones to ZONE 2 to enjoy audio in a separate room (ZONE 2) in addition to the main room.

■ 4. Network Connection

Make the network connection settings. There are two methods for network connection.

"Wired": Use a wired LAN to connect to a network.

"Wireless": Wi-Fi connection using an access point such as a wireless LAN router. There are two methods for Wi-Fi connection.

"Scan Networks": Search for an access point from this unit. Find out the SSID of the access point beforehand.

"Use iOS Device (iOS7 or later)": Share the Wi-Fi settings of your iOS device with this unit.

If you select "Scan Networks", there are another two types of connection methods. Check the following.

"Enter Password": Enter the password (or key) of the access point to connect.

"Push Button": If the access point is equipped with an automatic setting button, you can connect without entering the password.

- If the SSID of the access point is not displayed, select "Other..." with the cursor ► on the SSID list screen, press ENTER, and then follow the on-screen instructions.

Keyboard Input

To switch between upper and lower cases, select "A/a" on the screen, and press ENTER on the remote controller.

Press MEMORY on the remote controller to select whether to mask the password with "*" or display it in plain text. Pressing CLEAR on the remote controller will remove all the input characters.

- A confirmation screen asking you whether to agree to the privacy policy is

displayed during network setting. If you agree, select "Accept" and press ENTER.

■ 5. ARC Setup

To connect with an ARC-compatible TV, select "Yes". The ARC setting on this unit turns on, and you can listen to the TV's audio through this unit.

- If you select "Yes", the HDMI CEC function is enabled and power consumption increases during standby.

Troubleshooting

Before starting the procedure

Problems may be solved by simply turning the power on/off or disconnecting/connecting the power cord, which is easier than working on the connection, setting and operating procedure. Try the simple measures on both the unit and the connected device. If the problem is that the video or audio is not output or the HDMI linked operation does not work, disconnecting/connecting the HDMI cable may solve it. When reconnecting, be careful not to wind the HDMI cable since if wound the HDMI cable may not fit well. After reconnecting, turn off and on the unit and the connected device.

- The AV receiver contains a microPC for signal processing and control functions. In very rare situations, severe interference, noise from an external source, or static electricity may cause it to lockup. In the unlikely event that this happens, unplug the power cord from the wall outlet, wait at least 5 seconds, and then plug it back in.
- Onkyo is not responsible for damages (such as CD rental fees) due to unsuccessful recordings caused by the unit's malfunction. Before you record important data, make sure that the material will be recorded correctly.

When the unit is operating erratically 160

Try restarting the unit 160

Resetting the unit
(this resets the unit settings to the default) 160

Troubleshooting 161

■ Power 161

■ Audio 161

■ Listening Modes 163

■ Video 164

■ Linked operation 164

■ Tuner 165

■ BLUETOOTH function 165

■ Network function 166

■ USB storage device 167

■ Wireless LAN Network 167

■ Multi-zone function (for compatible models only) 168

■ Remote Controller 168

■ Display 169

■ Others 169

When the unit is operating erratically

❑ Try restarting the unit

Restarting this unit may solve the problem. After turning the unit to standby mode, press and hold the \odot ON/STANDBY button of the main unit for at least 5 seconds, and then restart the unit. (The settings on this unit are kept.) If the problem persists after restarting the unit, unplug and plug the power cords of this unit and connected devices.

❑ Resetting the unit (this resets the unit settings to the default)

If the restart of the unit does not solve the problem, reset the unit, and restore all the settings to the factory default at the time of purchase. This may solve the problem. If the unit is reset, your settings are restored to the default values. Be sure to note down your setting contents before performing the following operations.

1. While pressing and holding CBL/SAT of the input selector on the main unit, press the \odot ON/STANDBY button.
2. "Clear" is displayed on the display, and the unit returns to the standby state. Do not remove the power cord until "Clear" disappears from the display. To reset the remote controller, while pressing and holding MODE, press the $\leftrightarrow/\rightarrow$ button at least 3 seconds until the remote indicator blinks twice.

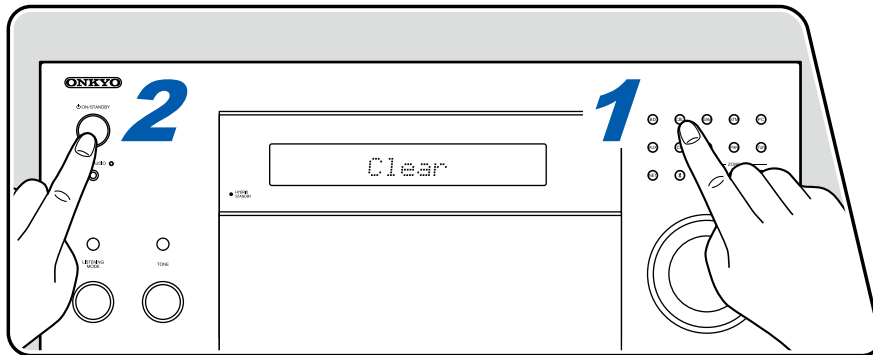

Troubleshooting

■ Power

❑ Cannot turn on the unit

- Make sure that the power cord is properly plugged into the wall outlet.
- Unplug the power cord from the outlet once, wait 5 seconds or more, then plug it in again.

(→p73)

❑ The unit turns off unexpectedly

- If "5. Hardware" - "Power Management" - "Auto Standby" on the Setup menu is activated, the unit automatically enters the standby mode.
- The protection circuit function may have operated. In such a case, if the power is turned on again, "AMP Diag Mode" is displayed on the main unit's display, and the unit enters the diagnosis mode to check the unit for abnormality. As the result, if no problem is found, "AMP Diag Mode" on the display disappears. Then, you can use the unit normally. If "CHECK SP WIRE" appears on the display, the speaker cables may be short-circuited. Check if the core wire of a speaker cable is not in contact with the core wire of another speaker cable or the rear panel, and turn the power on again. If "NG" is displayed, remove the power plug from the outlet immediately, and consult the dealer.
- The protection circuit function may have operated due to an abnormal rise in temperature of the unit. In such a case, the power turns off repeatedly even if the power is turned on each time. Secure sufficient ventilation space around the unit, wait for a while until the temperature of the unit decreases. Then, turn the power on again.

(→p144)

WARNING: If smoke, smell or abnormal noise is produced by the unit, unplug the power cord from the outlet immediately, and contact the dealer or Onkyo Support.

■ Audio

- Make sure that the speaker setup microphone is no longer connected.
- Confirm that the connection between the output jack on the connected device and the input jack on this unit is correct.
- Make sure that none of the connecting cables are bent, twisted, or damaged.
- If the MUTE indicator on the display blinks, press  on the remote controller to cancel muting.
- While headphones are connected to the PHONES jack, no sound is output from the speakers.
- When "Source" - "Audio Select" - "PCM Fixed Mode" in the Setup menu is set to "On", no sound is played if signals other than PCM are input. Change the setting to Off.

Check the following if the problem persists after you have confirmed the above.

❑ No sound from the TV

- Change the input selector on this unit to the position of the terminal to which the TV is connected.
- If the TV does not support the ARC function, along with the connection by an HDMI cable, connect the TV with this unit using a digital optical cable, digital coaxial cable, or analog audio cable.

(→p61)

❑ No sound from a connected player

- Change the input selector on this unit to the position of the terminal to which the player is connected.
- Check the digital audio output setting on the connected device. On some game consoles, such as those supporting DVD, the default setting may be off.
- For some DVD-Video discs, you need to select an audio output format from a menu.

❑ A speaker produces no sound

- Make sure that the polarity (+/-) of the speaker cables is correct, and that no bare wires are in contact with the metal part of speaker terminals. ([→p40](#))
- Make sure that the speaker cables are not shorting out.
- Check "Connect the Speaker Cables" ([→p40](#)) to see if the speaker connections have been made correctly. Settings for the speaker connection environment need to be made in "Speaker Setup" in Initial Setup. Check "Initial Setup with Auto Start-up Wizard" ([→p156](#)).
- Depending on the input signal and listening mode, not much sound may be output from speakers. Select another listening mode to see if sound is output.
- If surround back speakers are installed (for compatible models only), be sure to install surround speakers as well.
- A maximum of 7.1 ch playback is possible when Bi-Amping connection is used (for compatible models only). Be sure to remove the jumper bar on the speakers when using Bi-Amping connection.

❑ The subwoofer produces no sound

If the setting of the front speakers is "Full Band", the low range elements will be output from the front speakers instead of from the subwoofer during 2ch audio input of TV or music. To output the sound from the subwoofer, make one of the following settings.

1. Change the setting for the front speakers to a setting of crossover frequency value other than "Full Band".
The range below the specified frequency will be output from the subwoofer instead of from the front speakers. If your front speakers have a high low-range reproduction capability, changing this setting is not recommended.
 2. Change "Double Bass" to "On".
The low range elements of the front speakers will be output from both the front speakers and the subwoofer. Due to this, the bass sound may be emphasized too much. In such a case, do not change the setting, or make the setting with the above option 1.
- For the setting details, refer to "Setup Menu" - "2. Speaker" - "Crossover". ([→p133](#))
 - If the input signals do not contain subwoofer audio elements (LFE), the subwoofer may produce no sound.

❑ Noise can be heard

- Using cable ties to bundle audio pin cables, power cords, speaker cables, etc. may degrade the audio performance. Do not bundle the cords.
- An audio cable may be picking up interference. Change the position of the cables.

❑ The beginning of audio received by an HDMI IN cannot be heard

- Since it takes longer to identify the format of an HDMI signal than it does for other digital audio signals, audio output may not start immediately.

❑ Sound suddenly reduces

- When using the unit for extended periods with the temperature inside the unit exceeding a certain temperature, the volume may be reduced automatically to protect the circuits.

■ Listening Modes

- To enjoy digital surround playback in formats such as Dolby Digital, you need to make a connection for audio signals with an HDMI cable, digital coaxial cable or digital optical cable. Also, audio output need to be set to Bitstream output on the connected Blu-ray Disc player, etc.
- Press **i** on the remote controller several times to switch the display of the main unit, and you can check the input format.

Check the following if the problem persists after you have confirmed the above.

❑ Cannot select a desired listening mode

- Depending on the connection status of the speaker, some listening modes may not be selected. Refer to "Selectable Listening Modes" in "Listening Mode".

(→p112)

❑ Cannot listen to the sound in Dolby TrueHD, Dolby Atmos or DTS-HD Master Audio format (for compatible models only)

- You need to connect surround back speakers or height speakers to enjoy Dolby Atmos. Also, Dolby Atmos can be enjoyed only when the input signals are in Dolby Atmos formats.
- If the audio in Dolby TrueHD, Dolby Atmos or DTS-HD Master Audio format cannot be output correctly in the source format, set "BD video supplementary sound" (or reencode, secondary sound, video additional audio, etc.) to "Off" in the setting of a connected Blu-ray Disc player, etc. After changing the setting, switch the listening mode to that for each source, and confirm.

❑ Cannot select Pure Audio mode (for compatible models only)

- The Pure Audio mode cannot be selected when the Multi-zone function (for compatible models only) is on.

❑ About DTS signals

- With media that switches suddenly from DTS to PCM, PCM playback may not start immediately. In such a case, stop playback on the player side for approx. 3 seconds or more. Then, resume playback. The playback will be performed normally.
- DTS playback may not be performed normally on some CD and LD players even if the player and this unit are digitally connected. If some processing (e.g., output level adjustment, sampling frequency conversion, or frequency characteristic conversion) has been executed for the DTS signal being output, this unit cannot recognize it as a genuine DTS signal, and noise may occur.
- While playing a DTS-compatible disc, if a pause or skip operation is performed on your player, noise may occur for a short period. This is not a malfunction.

■ Video

- Confirm that the connection between the output jack on the connected device and the input jack on this unit is correct.
- Make sure that none of the connecting cables are bent, twisted, or damaged.
- When the TV image is blurry or unclear, the power cord or connection cables of the unit may have interfered. In such a case, keep distance between TV antenna cable and cables of the unit.
- Check the switching of the input screen on the monitor side such as a TV.

Check the following if the problem persists after you have confirmed the above.

□ No image appears.

- Change the input selector on this unit to the position of the terminal to which the player is connected.
- If the listening mode is Pure Audio (for compatible models only), the video signals input from jacks other than the HDMI IN jack are not output.

□ No image from a device connected to HDMI IN jack

- To display video from the connected player on the TV while the unit is in standby, you need to enable "5. Hardware" - "HDMI" - "HDMI Standby Through" in the Setup menu. For details of the HDMI Standby Through function, refer to "Setup Menu" - "5. Hardware" - "■ 1. HDMI". (→p141)
- To output video to a TV connected to the HDMI OUT SUB jack (for compatible models only), press Q on the remote controller to display "Quick Menu", and select "Other" - "HDMI Out". Then, select the HDMI OUT jack for output.
- Check if "Resolution Error" is displayed on the main unit display when video input via HDMI IN jack is not displayed. In this case, the TV does not support the resolution of the video input from the player. Change the setting on the player.
- Normal operation with an HDMI-DVI adapter is not guaranteed. In addition, video signals output from a PC are not guaranteed.

□ Images flicker

- The output resolution of the player may not be compatible with the resolution of the TV. If the player is connected to this unit with an HDMI cable, change the output resolution on the player. Also this may be solved by changing the screen mode on the TV.

□ Video and audio are out of synch

- Depending on the settings on your TV and connection environment, the video may be behind the audio. Press Q on the remote controller to display "Quick Menu", select "Other" - "A/V Sync", and make the adjustment. (→p148)

■ Linked operation

□ HDMI linked operation does not work with CEC-compliant devices, such as a TV

- In the Setup menu of the unit, set "5. Hardware" - "HDMI" - "HDMI CEC" to "On". (→p141)
- It is also necessary to set HDMI linking on the CEC-compliant device. Check the instruction manual.

■ Tuner

□ Poor reception or much noise

- Recheck the antenna connection.
- Move the antenna away from the speaker cord or power cord.
- Move the unit away from your TV or PC.
- Passing cars or airplanes in the vicinity can cause interference.
- If radio waves are blocked by concrete walls, etc., radio reception may be poor.
- Change the reception mode to mono.
- Operating the remote controller during AM reception may cause noise.
- FM reception may be clearer if you use the antenna jack on the wall used for the TV.

(→p69)

■ BLUETOOTH function

- Unplug and plug the power cord of the unit, or turn off and on the BLUETOOTH-enabled device. Restart of the BLUETOOTH-enabled device may be effective.
- BLUETOOTH-enabled devices must support the A2DP profile.
- Because a radio wave interference will occur, this unit may not be used near devices such as a microwave oven or cordless phone which use the radio wave in the 2.4 GHz range.
- A metallic object near the unit can affect on the radio wave, and BLUETOOTH connection may not be possible.

Check the following if the problem persists after you have confirmed the above.

□ Cannot connect with this unit

- Check if the BLUETOOTH function of the BLUETOOTH-enabled device is enabled.

(→p144)

□ Music playback is unavailable on the unit even after successful BLUETOOTH connection

- When the audio volume of your BLUETOOTH-enabled device is set low, the audio may not be played back. Turn up the volume of the BLUETOOTH-enabled device.
- Depending on the BLUETOOTH-enabled device, the Send/Receive selector switch may be equipped. Select Send mode.
- Depending on the characteristics or specifications of the BLUETOOTH-enabled device, music may not be played back on this unit.

□ Sound is interrupted

- There may a problem with the BLUETOOTH-enabled device. Check the information on a web page.

□ The audio quality is poor after connection with a BLUETOOTH-enabled device

- The BLUETOOTH reception is poor. Move the BLUETOOTH-enabled device closer to the unit, or remove any obstacle between the BLUETOOTH-enabled device and this unit.

■ Network function

- If you cannot select a network service, start up the network function to select it. It may take approx. one minute to start it up.
- When the NET indicator is blinking, this unit is not properly connected to the home network.
- Unplug and plug the power cords of this unit and the router, or restart the router.
- If the desired router is not displayed in the access point list, it may be set to hide SSID, or the ANY connection may be off. Change the setting and try again.

Check the following if the problem persists after you have confirmed the above.

□ Cannot access the Internet radio

- In the case the service provider has terminated the service, the network service or contents may not be used on this unit.
- Check if your modem and router are properly connected, and they are both turned on.
- Check if the LAN side port on the router is properly connected to this unit.
- Check if connecting to Internet from other devices is possible. If it is not possible, turn off all devices connected to the network, wait for a while, and then turn on the devices again.
- If only the specific radio station is unavailable for listening, check if the registered URL is correct, and if the format distributed from the radio station is supported by this unit.
- Depending on ISP, setting the proxy server is required.
- Check if the router and modem you are using are supported by your ISP.

□ Cannot access the network server

- This unit needs to be connected to the same router as the network server.
- This unit supports the Windows Media® Player 11 or 12 network servers, or NASes that support the home network function.
- Windows Media® Player may require some settings. Refer to "Playing back files on a PC and NAS (Music Server)".
- When using a PC, only the music files registered in the library of Windows Media® Player can be played.

(→p86)

□ Sound is interrupted when playing music files on the network server

- Check if the network server meets the requirements for operation.
- When the PC is serving as the network server, quit application software other than the server software (Windows Media® Player 12, etc.).
- If the PC is downloading or copying large files, the playback sound may be interrupted.

□ The initial setup of Chromecast built-in cannot be performed on Onkyo Controller App

- If you have agreed to the privacy policy that requires agreement to use the Chromecast built-in function during the Initial Setup of this unit, you do not have to agree to the privacy policy on Onkyo Controller App.

■ USB storage device

□ USB storage device is not displayed

- Check if the USB storage device or USB cable is securely inserted to the USB port of the unit.
- Disconnect the USB storage device once from the unit, and then reconnect it.
- Performance of the hard disk that receive power from the USB port of the unit is not guaranteed.
- Depending on the type of content, the playback may not be performed normally. Check the types of supported file formats.
- Operations of USB storage devices equipped with security functions are not guaranteed.

(→p83)

■ Wireless LAN Network

- Unplug and plug the power cords of this unit and the wireless LAN router, check the power-on status of the wireless LAN router, or restart the wireless LAN router.

Check the following if the problem persists after you have confirmed the above.

□ Cannot access wireless LAN network

- The wireless LAN router setting may be switched to Manual. Restore the setting to Auto.
- Try the manual set-up. The connection may succeed.
- When the wireless LAN router is in stealth mode (mode to hide SSID) or when the ANY connection is off, the SSID is not displayed. Change the setting and try again.
- Check if the SSID and encryption settings (WEP, etc.) are correct. Match the network settings with the settings of this unit.
- Connection to an SSID that includes multi-byte characters is not supported. Set the SSID of the wireless LAN router using single-byte alphanumeric characters only, and try again.

□ Connected to an SSID different from the selected SSID

- Some wireless LAN routers allow you to set multiple SSIDs for one unit. If connecting to such a router using the automatic setting button, you may end up connecting to an SSID different from the SSID you want to connect to. If this occurs, use the connection method requiring you to enter a password

❑ Playback sound is interrupted, or communication is not possible

- You may not receive radio waves due to poor radio wave conditions. Shorten the distance from the wireless LAN router, or remove obstacles to improve visibility, and connect again. Install the unit away from microwave ovens or other access points. It is recommended to install the wireless LAN router and the unit in the same room.
- If there is a metallic object near the unit, wireless LAN connection may not be possible because the metal affects the radio wave.
- When other wireless LAN devices are used near the unit, other symptoms may occur, such as interrupted playback and impossible communication. You can avoid those problems by changing the channel of your wireless LAN router. For instructions on changing channels, refer to the instruction manual supplied with your wireless LAN router.
- There may not be enough bandwidth available in wireless LAN. Use a wired LAN for connection.

■ Multi-zone function (for compatible models only)

❑ Cannot ZONE-output the audio of externally connected AV components

- To output audio from an externally connected AV component to ZONE 2, connect it to any of HDMI IN1 to IN3 jacks. If the AV component is not equipped with an HDMI jack, use a digital coaxial cable, digital optical cable or analog audio cable. Also, the audio from externally connected AV components can be output to ZONE 2 only when the audio is analog or 2ch PCM signal. When the AV component is connected to this unit with an HDMI cable, digital coaxial cable or digital optical cable, change the audio output of the AV component to the PCM output. (→p67)
- When video and audio via HDMI input are output to ZONE 2, set "1. Input/Output Assign" - "TV Out / OSD" - "Zone2 HDMI" (→p128) to "Use" on the Setup menu.
- To output audio from an externally connected AV component to ZONE 3, use an analog audio cable for connection. Also, audio from externally connected AV components can be output to ZONE 3 only when it is an analog audio signal.

❑ Others

- If the audio signal is from the NET input selector, the zone output is not possible for DSD and Dolby TrueHD audio signals.

■ Remote Controller

- Make sure that the batteries are inserted with the correct polarity.
- Insert new batteries. Do not mix different types of batteries, or old and new batteries.
- Make sure that the sensor of the main unit is not subjected to direct sunlight or inverter-type fluorescent lights. Relocate it if necessary.
- If the main unit is installed in a rack or cabinet with colored-glass doors, or if the doors are closed, the remote controller may not work normally.
- After operating the Multi-zone function (for compatible models only), the remote controller mode may be switched to the mode for operating the ZONE output audio. Check "Multi-zone", and switch the remote controller mode to the mode for controlling the main room. (→p98)

■ Display

□ The display does not light up

- When the Dimmer function is working, the display may go dim or turn off (for compatible models only). Press the DIMMER button, and change the brightness level of the display.
- The display is turned off when the Pure Audio (for compatible models only) listening mode is selected.

(→p7)

■ Others

□ Strange noise can be heard from the unit

- If you have connected another device to the same outlet as this unit, strange noise may occur under the influence of the device. If the symptom is remedied by removing the power plug of the other device from the outlet, use different outlets for this unit and the device.

□ The message "Noise Error" appears during AccuEQ Room Calibration

- This can be caused by a malfunction in your speaker unit. Check the speaker output, etc.

□ The measurement results of AccuEQ Room Calibration show different distances to the speakers from the actual ones

- Depending on the speakers you are using, some errors may occur in the measurement results. If this is the case, make the settings in "2. Speaker" - "Distance" in the Setup menu.

(→p134)

□ The measurement results of AccuEQ Room Calibration show that the volume level of the subwoofer has been corrected to the lower limit

- The volume level correction of the subwoofer may not have been completed. Lower the volume of the subwoofer before AccuEQ Room Calibration measurement.

About HDMI

Compatible functions

HDMI (High Definition Multimedia Interface) is a digital interface standard for connecting TVs, projectors, Blu-ray Disc/DVD players, digital tuners, and other video components. Several separate video and audio cables have been required to connect AV components so far. With HDMI, a single cable can transmit control signals, digital video and digital audio (2-channel PCM, multichannel digital audio, and multichannel PCM).

HDMI CEC function:

By connecting a device that complies with CEC (Consumer Electronics Control) of the HDMI standard using an HDMI cable, a variety of linked operations between devices are possible. This function enables various linking operations with players, such as switching input selectors interlocking with a player, adjusting the volume of this unit using the remote controller of a TV, and automatically switching this unit to standby when the TV is turned off. The unit is designed to link with products that comply with the CEC standard, however, linked operation is not always guaranteed with all CEC devices. For linked functions to work properly, do not connect CEC-compliant devices exceeding the connectable number to the HDMI jack as shown below.

- Blu-ray Disc/DVD players: up to 3 units
- Blu-ray Disc/DVD recorders: up to 3 units
- Cable TV tuner, terrestrial digital tuner, and satellite broadcasting tuner: up to 4 units

Operation has been confirmed on the following devices: (As of January 2018)
Toshiba brand televisions; Sharp brand televisions; Onkyo and Integra brand RIHD-compatible players; Toshiba brand players and recorders; Sharp brand players and recorders (when used with a Sharp brand television)

ARC (Audio Return Channel):

By connecting an ARC-compliant TV with a single HDMI cable, you can output the audio and video from this unit to the TV, and also input the audio from the TV to this unit.

HDMI Standby Through:

Even if this unit is in standby mode, the input signals from AV components can be transmitted to the TV.

Deep Color:

By connecting devices supporting Deep Color, video signals input from the devices can be reproduced on the TV with even more colors.

x.v.Color™:

This technology reproduces even more realistic colors by expanding the color gamut.

3D:

You can transmit 3D video signals from AV components to the TV.

4K:

This unit supports 4K (3840×2160p) and 4K SMPTE (4096×2160p) video signals.

Lip Sync:

This setting automatically corrects desynchronization between the video and audio signals based on the information from the HDMI Lip Sync-compatible TV.

Copyright Protection:

The HDMI jack of this unit conforms to the Revision 1.4 and Revision 2.2 standards of the HDCP (High-bandwidth Digital Content Protection), a copy protection system for digital video signals. Other devices connected to the unit must also conform to the HDCP standards.

Supported Audio Formats

2 ch linear PCM:

32 kHz, 44.1 kHz, 48 kHz, 88.2 kHz, 96 kHz, 176.4 kHz, 192 kHz, 16/20/24 bit

Multi-channel linear PCM:

Maximum 7.1 channels, 32 kHz, 44.1 kHz, 48 kHz, 88.2 kHz, 96 kHz, 176.4 kHz, 192 kHz, 16/20/24 bit

Bitstream:

Dolby Atmos, Dolby Digital, Dolby Digital Plus, Dolby TrueHD, DTS, DTS:X, DTS-HD High Resolution Audio, DTS-HD Master Audio

DSD:

Supported sampling rates: 2.8 MHz

Your Blu-ray Disc/DVD player must also support the HDMI output of the above audio formats.

- 4K (3840×2160p) 24/25/30Hz, 4K SMPTE (4096×2160p) 24/25/30Hz : RGB/YCbCr4:4:4 (8 bit), YCbCr4:2:2 (12 bit)
- 4K (3840×2160p) 50/60Hz, 4K SMPTE (4096×2160p) 50/60Hz : YCbCr4:2:0 (8 bit)

Supported resolutions

HDMI IN1 to IN6:

- Copyright protection technology: HDCP1.4/HDCP2.2
- Color space (Color Depth):
 - 720×480i 60Hz, 720×576i 50Hz, 720×480p 60Hz, 720×576p 50Hz, 1920×1080i 50/60Hz, 1280×720p 24/25/30/50/60Hz, 1680×720p 24/25/30/50/60Hz, 1920×1080p 24/25/30/50/60Hz, 2560×1080p 24/25/30/50/60Hz, 4K (3840×2160p) 24/25/30Hz, 4K SMPTE (4096×2160p) 24/25/30Hz : RGB/YCbCr4:4:4 (8/10/12 bit), YCbCr4:2:2 (12 bit)
 - 4K (3840×2160p) 50/60Hz, 4K SMPTE (4096×2160p) 50/60Hz : RGB/YCbCr4:4:4 (8 bit), YCbCr4:2:2 (12 bit), YCbCr4:2:0 (8/10/12 bit)

AUX INPUT HDMI (front):

- Copyright protection technology: HDCP1.4/HDCP2.2
- Color space (Color Depth):
 - 720×480i 60Hz, 720×576i 50Hz, 720×480p 60Hz, 720×576p 50Hz, 1920×1080i 50/60Hz, 1280×720p 24/25/30/50/60Hz, 1680×720p 24/25/30/50/60Hz, 1920×1080p 24/25/30/50/60Hz, 2560×1080p 24/25/30/50/60Hz : RGB/YCbCr4:4:4 (8/10/12 bit), YCbCr4:2:2 (12 bit)

General Specifications

■ Amplifier Section

Rated Output Power (FTC) (North American)

With 8 ohm loads, both channels driven, from 20-20,000 Hz; rated 120 watts per channel minimum RMS power, with no more than 0.08% total harmonic distortion from 250 milliwatts to rated output.

Rated Output Power (IEC) (Others)

9 ch × 180 W at 6 ohms, 1 kHz, 1 ch driven of 1% THD

Maximum Effective Output Power (North American)

250 W at 6 ohms, 1 kHz, 1 ch driven of 10% THD

Maximum Effective Output Power (JEITA)

9 ch × 215 W at 6 ohms, 1 kHz, 1 ch driven of 10% THD (Asian and Australian)

Dynamic Power (*)

* IEC60268-Short-term maximum output power

250 W (3 Ω, Front)

220 W (4 Ω, Front)

130 W (8 Ω, Front)

THD+N (Total Harmonic Distortion+Noise)

0.08% (20 Hz - 20,000 Hz, half power)

Input Sensitivity and Impedance

200 mV/47 kΩ (LINE (RCA))

3.5 mV/47 kΩ (PHONO MM)

Rated RCA Output Level and Impedance

1 V/470 Ω (PRE OUT)

1 V/470 Ω (SUBWOOFER PRE OUT)

1V, 200 mV/470 Ω (ZONE 2 PRE/LINE OUT)

1V, 200 mV/470 Ω (ZONE 3 PRE/LINE OUT)

Phono Maximum Input Signal Voltage

70 mV (MM 1 kHz 0.5%)

Frequency Response

5 Hz - 100 kHz/+1 dB, -3 dB (Direct/Pure Audio)

Tone Control Characteristics (MAIN)

±10 dB, 20 Hz (BASS)

±10 dB, 20 kHz (TREBLE)

Tone Control Characteristics (ZONE 2)

±10 dB, 100 Hz (BASS)

±10 dB, 10 kHz (TREBLE)

Signal to Noise Ratio

106 dB (IHF-A, LINE IN, SP OUT)

80 dB (IHF-A, PHONO IN, SP OUT)

Speaker Impedance

4 Ω - 16 Ω

Headphone Rated Output

85 mW + 85 mW (32 Ω, 1 kHz, 10% THD)

Supported impedance of Headphones

8 Ω - 600 Ω

Headphones Frequency Response

10 Hz - 100 kHz

■ Video Section

Signal level

1 Vp-p/75 Ω (Composite Video)

1 Vp-p/75 Ω (Component Video Y)

0.7 Vp-p/75 Ω (Component Video Pb/Pr)

Maximum resolution supported by component video

480i/576i

■ Tuner Section

FM Tuning Frequency Range

87.5 MHz - 107.9 MHz (North American)

87.5 MHz - 108.0 MHz, RDS (Others)

50dB quieting sensitivity (FM MONO)

1.56 μV, 15.0 dBf (IHF, 1kHz, 100% MOD)

AM Tuning Frequency Range

530 kHz - 1710 kHz (North American)

522/530 kHz - 1611/1710 kHz (Others)

Preset Channel

40

■ Network Section

Ethernet LAN

10BASE-T/100BASE-TX

Wireless LAN

IEEE 802.11 a/b/g/n standard
(Wi-Fi® standard)
5 GHz/2.4 GHz band

■ BLUETOOTH Section

Communication system

BLUETOOTH Specification version 4.1+LE

Frequency band

2.4 GHz band

Modulation method

FHSS (Freq Hopping Spread Spectrum)

Compatible BLUETOOTH profiles

A2DP 1.2

AVRCP 1.3

HOGP-Host (Client)

HOGP-HID Device (Server)

HID Service (HIDS)

Supported Codecs

SBC

AAC

Transmission range (A2DP)

20 Hz - 20 kHz (Sampling frequency 44.1 kHz)

Maximum communication range

Line of sight approx. 15 m (*)

- * The actual range will vary depending on factors such as obstacles between devices, magnetic fields around a microwave oven, static electricity, cordless phone, reception sensitivity, antenna's performance, operating system, software application, etc.

■ General

Power Supply

AC 120 V, 60 Hz (North American)

AC 220 - 240 V, 50/60 Hz (Others)

Power Consumption

850 W (North American)

870 W (Others)

0.15 W (Full Standby mode)

1.5 W (Network Standby (wired)) (North American)

1.6 W (Network Standby (wired)) (Others)

1.8 W (Network Standby (wireless)) (North American)

1.9 W (Network Standby (wireless)) (Others)

1.5 W (Bluetooth Wakeup)

0.15 W (HDMI CEC)

2 W (Standby mode (ALL ON)) (North American)

2.2 W (Standby mode (ALL ON)) (Others)

70 W (No-sound)

6 W (HDMI Standby Through) (North American)

6.1 W (HDMI Standby Through) (Others)

Dimensions (W × H × D)

435 mm × 201.5 mm × 398 mm

17-1/8" × 7-15/16" × 15-11/16"

Weight

14 kg (30.9 lbs.)

Maximum radio-frequency power transmitted in the frequency band(s)

2400 MHz - 2483.5 MHz (20 dBm (e.i.r.p))

5150 MHz - 5350 MHz (22 dBm (e.i.r.p))

5470 MHz - 5725 MHz (22 dBm (e.i.r.p))

■ HDMI

Input

IN1 (BD/DVD), IN2 (CBL/SAT), IN3 (GAME), IN4 (STRM BOX), IN5 (PC),
IN6, AUX INPUT HDMI (front)

Output

OUT MAIN (ARC), OUT ZONE 2/SUB

Supported

Deep Color, x.v.Color™, Lip Sync, Audio Return Channel, 3D, 4K, CEC, Extended Colorimetry (sYCC601, Adobe RGB, Adobe YCC601), Content Type, HDR (HDR10, BT.2020, HLG), Dolby Vision

Audio Format

Dolby Atmos, Dolby TrueHD, Dolby Digital, Dolby Digital Plus, DTS, DTS:X, DTS-HD Master Audio, DTS-HD High Resolution Audio, DTS 96/24, DTS-ES, DTS Express, DSD, PCM

HDCP version

2.2

Maximum Video Resolution

4k 60 Hz (YCbCr 4:4:4)

■ Video Inputs

Component

IN1 (BD/DVD), IN2 (GAME)

Composite

IN1 (CBL/SAT), IN2 (STRM BOX)

■ Supported input resolutions

HDMI input

4K, 1080p/24, 1080p, 1080i, 720p, 480p/576p

Component input

480i/576i

Composite input

480i/576i

- Signals are output from the HDMI OUT jack of this unit to the TV with the same resolution as the input resolution.

■ Audio Inputs

Digital

OPTICAL 1 (CD), 2 (TV)
COAXIAL (BD/DVD)

Analog

BD/DVD, CBL/SAT, GAME, STRM BOX, CD, TV, PHONO

■ Audio Outputs

Analog

PRE OUT (FRONT L/R, CENTER, SURROUND L/R, HEIGHT 1 L/R, SURROUND BACK L/R, 2 SUBWOOFER, HEIGHT 2 L/R)
ZONE2 PRE/LINE OUT
ZONE3 PRE/LINE OUT

Speaker Outputs

FRONT L/R, CENTER, SURROUND L/R, HEIGHT 1 L/R, SURROUND BACK L/R or HEIGHT 2 L/R or ZONE 3 L/R, ZONE 2 L/R (North American models support banana plugs.)

Phones

PHONES (Front, ø 6.3 mm, 1/4")

■ Others

Setup Mic: 1 (Front)

USB: 1 (Ver. 2.0, 5 V/1 A)

Ethernet: 1

RS232 : 1

IR IN : 1

12V TRIGGER OUT : 1 (100 mA)

■ Power consumption in standby mode

- In the following cases, the power consumption in standby mode may reach up to a maximum of 14 W:
 - When "Network Standby" is set to "On"
 - When "HDMI CEC" is set to "On"
 - When "HDMI Standby Through" is set to other than "Off"
 - When "Bluetooth Wakeup" is set to "On"
 - When "USB Power Out at Standby" is set to "On"

Specifications and features are subject to change without notice.

☐ → [License and Trademark](#)

ONKYO

SN 29403465_EN

(C) Copyright 2018 Onkyo & Pioneer Corporation Japan. All rights reserved. Onkyo group has established its Privacy Policy, available at [<http://www.onkyo.com/privacy/>].

H1805-0