



## COMPACT DISC PLAYER

# PD-30AE

# PD-10AE

## Instruction Manual

Thank you for purchasing Pioneer product. Please read this manual carefully before making any connections or using this product. By following these instructions, you'll get the best audio performance and the most listening pleasure from your Pioneer product. Keep this manual for future reference.

**Getting Started** .....En-2

**Connections** ..... En-13

**Basic Operation**..... En-15

**Disc Playback** ..... En-16

**Various Playback Modes**..... En-21

**Setting for MP3** ..... En-24

**Troubleshooting** ..... En-26

**Specifications** ..... En-27



## WARNING:

TO REDUCE THE RISK OF FIRE OR ELECTRIC SHOCK, DO NOT EXPOSE THIS APPARATUS TO RAIN OR MOISTURE.

## CAUTION:

TO REDUCE THE RISK OF ELECTRIC SHOCK, DO NOT REMOVE COVER (OR BACK). NO USER-SERVICEABLE PARTS INSIDE. REFER SERVICING TO QUALIFIED SERVICE PERSONNEL.



**WARNING**  
RISK OF ELECTRIC SHOCK  
DO NOT OPEN

**AVIS**  
RISQUE DE CHOC ELECTRIQUE  
NE PAS OUVRIR



The lightning flash with arrowhead symbol, within an equilateral triangle, is intended to alert the user to the presence of uninsulated "dangerous voltage" within the product's enclosure that may be of sufficient magnitude to constitute a risk of electric shock to persons.



The exclamation point within an equilateral triangle is intended to alert the user to the presence of important operating and maintenance (servicing) instructions in the literature accompanying the appliance.

## Important Safety Instructions

1. Read these instructions.
2. Keep these instructions.
3. Heed all warnings.
4. Follow all instructions.
5. Do not use this apparatus near water.
6. Clean only with dry cloth.
7. Do not block any ventilation openings. Install in accordance with the manufacturer's instructions.
8. Do not install near any heat sources such as radiators, heat registers, stoves, or other apparatus (including amplifiers) that produce heat.
9. Do not defeat the safety purpose of the polarized or grounding-type plug. A polarized plug has two blades with one wider than the other. A grounding type plug has two blades and a third grounding prong. The wide blade or the third prong are provided for your safety. If the provided plug does not fit into your outlet, consult an electrician for replacement of the obsolete outlet.
10. Protect the power cord from being walked on or pinched particularly at plugs, convenience receptacles, and the point where they exit from the apparatus.
11. Only use attachments/accessories specified by the manufacturer.
12. Use only with the cart, stand, tripod, bracket, or table specified by the manufacturer, or sold with the apparatus. When a cart is used, use caution when moving the cart/apparatus combination to avoid injury from tip-over.  

PORTABLE CART WARNING  
S3125A
13. Unplug this apparatus during lightning storms or when unused for long periods of time.
14. Refer all servicing to qualified service personnel. Servicing is required when the apparatus has been damaged in any way, such as power-supply cord or plug is damaged, liquid has been spilled or objects have fallen into the apparatus, the apparatus has been exposed to rain or moisture, does not operate normally, or has been dropped.
15. Damage Requiring Service  
Unplug the apparatus from the wall outlet and refer servicing to qualified service personnel under the following conditions:
  - A. When the power-supply cord or plug is damaged,
  - B. If liquid has been spilled, or objects have fallen into the apparatus,
  - C. If the apparatus has been exposed to rain or water,
  - D. If the apparatus does not operate normally by following the operating instructions. Adjust only those controls that are covered by the operating instructions as an improper adjustment of other controls may result in damage and will often require extensive work by a qualified technician to restore the apparatus to its normal operation,
  - E. If the apparatus has been dropped or damaged in any way, and
  - F. When the apparatus exhibits a distinct change in performance this indicates a need for service.
16. Object and Liquid Entry  
Never push objects of any kind into the apparatus through openings as they may touch dangerous voltage points or short-out parts that could result in a fire or electric shock.  
The apparatus shall not be exposed to dripping or splashing and no objects filled with liquids, such as vases shall be placed on the apparatus.  
Don't put candles or other burning objects on top of this unit.
17. Batteries  
Always consider the environmental issues and follow local regulations when disposing of batteries.
18. If you install the apparatus in a built-in installation, such as a bookcase or rack, ensure that there is adequate ventilation.  
Leave 20 cm (8") of free space at the top and sides and 10 cm (4") at the rear. The rear edge of the shelf or board above the apparatus shall be set 10 cm (4") away from the rear panel or wall, creating a flue-like gap for warm air to escape.

# Precautions

---

1. **Recording Copyright**—Unless it's for personal use only, recording copyrighted material is illegal without the permission of the copyright holder.
2. **AC Fuse**—The AC fuse inside the unit is not user-serviceable. If you cannot turn on the unit, contact the dealer from whom you purchased this unit.
3. **Care**—Occasionally you should dust the unit all over with a soft cloth. For stubborn stains, use a soft cloth dampened with a weak solution of mild detergent and water. Dry the unit immediately afterwards with a clean cloth. Don't use abrasive cloths, thinners, alcohol, or other chemical solvents, because they may damage the finish or remove the panel lettering.

## 4. Power

### WARNING

BEFORE PLUGGING IN THE UNIT FOR THE FIRST TIME, READ THE FOLLOWING SECTION CAREFULLY.

AC outlet voltages vary from country to country. Make sure that the voltage in your area meets the voltage requirements printed on the unit's rear panel (e.g., AC 220-240 V, 50/60 Hz or AC 120 V, 60 Hz).

The power cord plug is used to disconnect this unit from the AC power source. Make sure that the plug is readily operable (easily accessible) at all times.

Pressing the [STANDBY/ON] button to select Standby mode does not fully disconnect from the mains. If you do not intend to use the unit for an extended period, remove the power cord from the AC outlet.

## 5. Preventing Hearing Loss

### Caution

Excessive sound pressure from earphones and headphones can cause hearing loss.

## 6. Batteries and Heat Exposure

### Warning

Batteries (battery pack or batteries installed) shall not be exposed to excessive heat as sunshine, fire or the like.

7. **Never Touch this Unit with Wet Hands**—Never handle this unit or its power cord while your hands are wet or damp. If water or any other liquid gets inside this unit, have it checked by the dealer from whom you purchased this unit.

## 8. Handling Notes

- If you need to transport this unit, use the original packaging to pack it how it was when you originally bought it.
- Do not leave rubber or plastic items on this unit for a long time, because they may leave marks on the case.
- This unit's top and rear panels may get warm after prolonged use. This is normal.
- If you do not use this unit for a long time, it may not work properly the next time you turn it on, so be sure to use it occasionally.
- When you've finished using this unit, remove all discs and turn off the power.

## 9. Installing this Unit

- Install this unit in a well-ventilated location.
- Ensure that there's adequate ventilation all around this unit, especially if it's installed in an audio rack. If the ventilation is inadequate, the unit may overheat, leading to malfunction.
- Do not expose this unit to direct sunlight or heat sources, because its internal temperature may rise, shortening the life of the optical pickup.
- Avoid damp and dusty places, and places subject to vibrations from loudspeakers. Never put the unit on top of, or directly above a loudspeaker.
- Install this unit horizontally. Never use it on its side or on a sloping surface, because it may cause a malfunction.
- If you install this unit near a TV, radio, or VCR, the picture and sound quality may be affected. If this occurs, move this unit away from the TV, radio, or VCR.

## 10. Moisture Condensation

### Moisture condensation may damage this unit.

Read the following carefully:

Moisture may condense on the lens of the optical pickup, one of the most important parts inside this unit.

- Moisture condensation can occur in the following situations:
  - The unit is moved from a cold place to a warm place.
  - A heater is turned on, or cold air from an air conditioner is hitting the unit.
  - In the summer, when this unit is moved from an air conditioned room to a hot and humid place.
  - The unit is used in a humid place.
- Do not use this unit when there's the possibility of moisture condensation occurring. Doing so may damage your discs and certain parts inside this unit.

If condensation does occur, unplug the power cord and leave the unit for two to three hours in the room temperature.

This unit contains a semiconductor laser system and is classified as a "CLASS 1 LASER PRODUCT". So, to use this model properly, read this Instruction Manual carefully. In case of any trouble, please contact the store where you purchased the unit.

To prevent being exposed to the laser beam, do not try to open the enclosure.

### CAUTION:

CLASS 1M VISIBLE AND INVISIBLE LASER RADIATION WHEN OPEN. DO NOT VIEW DIRECTLY WITH OPTICAL INSTRUMENTS.

THIS PRODUCT UTILIZES A LASER. USE OF CONTROLS OR ADJUSTMENTS OR PERFORMANCE OF PROCEDURES OTHER THAN THOSE SPECIFIED HEREIN MAY RESULT IN HAZARDOUS RADIATION EXPOSURE.

## Precautions-Continued

The label on the right is applied on the rear panel.



1. This unit is a CLASS 1 LASER PRODUCT and employs a laser inside the cabinet.
2. To prevent the laser from being exposed, do not remove the cover. Refer servicing to qualified personnel.

### For U.S. models

#### FCC Information for User

##### CAUTION:

The user changes or modifications not expressly approved by the party responsible for compliance could void the user's authority to operate the equipment.

##### NOTE:

This equipment has been tested and found to comply with the limits for a Class B digital device, pursuant to Part 15 of the FCC Rules. These limits are designed to provide reasonable protection against harmful interference in a residential installation.

This equipment generates, uses and can radiate radio frequency energy and, if not installed and used in accordance with the instructions, may cause harmful interference to radio communications. However, there is no guarantee that interference will not occur in a particular installation. If this equipment does cause harmful interference to radio or television reception, which can be determined by turning the equipment off and on, the user is encouraged to try to correct the interference by one or more of the following measures:

- Reorient or relocate the receiving antenna.
- Increase the separation between the equipment and receiver.
- Connect the equipment into an outlet on a circuit different from that to which the receiver is connected.
- Consult the dealer or an experienced radio/TV technician for help.

### For Canadian Models

##### NOTE: CAN ICES-3 B/NMB-3 B

For models having a power cord with a polarized plug:

**CAUTION:** TO PREVENT ELECTRIC SHOCK, MATCH WIDE BLADE OF PLUG TO WIDE SLOT, FULLY INSERT.

### Modèle pour les Canadien

##### REMARQUE: CAN ICES-3 B/NMB-3 B

Sur les modèles dont la fiche est polarisée:

**ATTENTION:** POUR ÉVITER LES CHOCS ÉLECTRIQUES, INTRODUIRE LA LAME LA PLUS LARGE DE LA FICHE DANS LA BORNE CORRESPONDANTE DE LA PRISE ET POUSSER JUSQU'AU FOND.

### For British models

Replacement and mounting of an AC plug on the power supply cord of this unit should be performed only by qualified service personnel.

##### IMPORTANT

The wires in the mains lead are coloured in accordance with the following code:

Blue: Neutral

Brown: Live

As the colours of the wires in the mains lead of this apparatus may not correspond with the coloured markings identifying the terminals in your plug, proceed as follows:

The wire which is coloured blue must be connected to the terminal which is marked with the letter N or coloured black.

The wire which is coloured brown must be connected to the terminal which is marked with the letter L or coloured red.

##### IMPORTANT

The plug is fitted with an appropriate fuse. If the fuse needs to be replaced, the replacement fuse must approved by ASTA or BSI to BS1362 and have the same ampere rating as that indicated on the plug. Check for the ASTA mark or the BSI mark on the body of the fuse.

If the power cord's plug is not suitable for your socket outlets, cut it off and fit a suitable plug. Fit a suitable fuse in the plug.

### For European Models

Manufacturer:  
**Onkyo & Pioneer Corporation**  
2-3-12 Yaesu, Chuo-ku,  
Tokyo  
104-0028 JAPAN

EU Representative's:  
**Pioneer Europe NV**  
Haven 1087,  
Keetberglaan 1, 9120  
Melsele, Belgium  
<http://www.pioneer.eu>



We declare, under our sole responsibility, that this product complies with the standards:

- Safety
- Limits and methods of measurement of radio disturbance characteristics
- Limits for harmonic current emissions
- Limitation of voltage changes, voltage fluctuations and flicker
- RoHS Directive, 2011/65/EU

##### WEEE

<http://www.onkyo.com/manual/weee/weee.pdf>

# Supplied Accessories

---

Make sure you have the following accessories

---

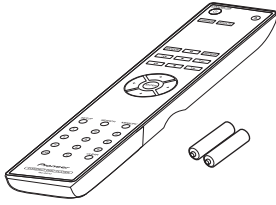

**Remote controller RC-947C and two batteries (R03/AAA)**

---



**Audio cable (80 cm)**

---



**Power cord (PD-30AE only)**

---

\* In catalogs and on packaging, the letter at the end of the product name indicates the color. Specifications and operations are the same regardless of color.

# Features

---

- 24bit 192KHz D/A converter
  - MP3 playback
  - 25-track memory playback
  - SR compatible remote control (PD-30AE only)
  - Auto standby
  - Coaxial and optical digital audio output (PD-30AE only)
  - Random playback
  - Random repeat playback
  - Headphones output (PD-30AE only)
-

# Contents

---

<b>Precautions</b> .....	<b>3</b>
<b>Supplied Accessories</b> .....	<b>5</b>
<b>Features</b> .....	<b>5</b>
<b>Getting to Know the CD Player</b> .....	<b>7</b>
Front Panel .....	7
Display .....	8
Rear Panel.....	9
Remote Controller.....	10
Installing the Batteries .....	11
Aiming the Remote Controller.....	11
<b>Disc Notes</b> .....	<b>12</b>
<b>Connecting the CD Player</b> .....	<b>13</b>
Audio Connections.....	13
Using centralized control with other Pioneer components (PD-30AE only).....	14
<b>Connecting the Power Cord</b> .....	<b>14</b>
<b>Basic Operation</b> .....	<b>15</b>
Turning On CD Player .....	15
Setting Auto Standby (ASb).....	15
Changing the Display Brightness.....	15
Using Headphones .....	15
<b>Disc Playback</b> .....	<b>16</b>
Using the Remote Controller .....	17
Displaying CD Information .....	17
Selecting Files (MP3 CDs).....	18
Selecting Files in Navigation Mode.....	18
Selecting Files in All Folder Mode .....	19
Selecting a Folder during Playback (Search Mode) .....	19
Displaying MP3 Information.....	20
<b>Various Playback Modes</b> .....	<b>21</b>
Random Playback.....	21
Memory Playback (For Audio CDs) .....	21
Memory Playback (For MP3 CDs).....	22
Repeat Playback.....	23
<b>Setting for MP3</b> .....	<b>24</b>
Setting MP3 Preferences.....	24
<b>Troubleshooting</b> .....	<b>26</b>
<b>Specifications</b> .....	<b>27</b>

# Getting to Know the CD Player

## Front Panel

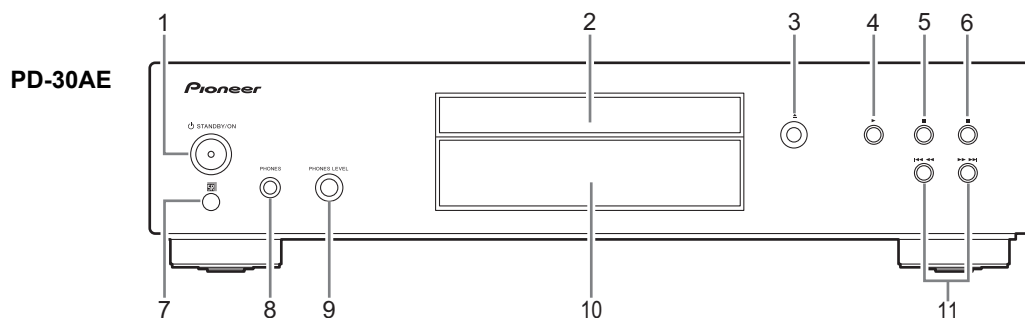

- 1. STANDBY/ON button (15)**  
Press to turn on or standby the PD-30AE.
- 2. Disc tray (16)**  
The CD is loaded here.
- 3. Open/Close button (16)**  
Press to open and close the disc tray.
- 4. Play button (16 – 19, 21, 22)**  
Press to start playback.
- 5. Pause button (16, 17)**  
Press to pause playback.
- 6. Stop button (16 – 19, 24)**  
Press to stop playback.
- 7. Remote control sensor (11)**  
Receives control signals from the remote controller.
- 8. Display (8)**  
See next page.
- 9. PHONES LEVEL knob (15)**  
Use to control the phones level.  
Turn the knob clockwise to increase the phones level and counterclockwise to decrease it.
- 10. Display (8)**  
See next page.
- 11. [ ]/[ ] buttons (16 – 19, 21)**  
Press to select the previous or next track.  
Hold down the buttons to fast-reverse or fast-forward during playback.

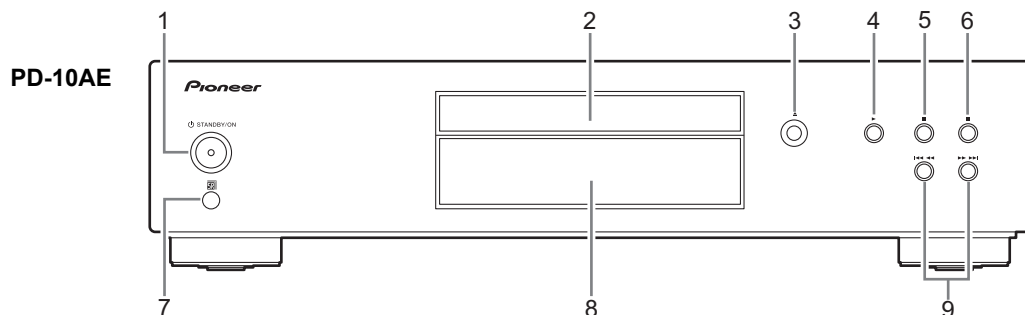

- 1. STANDBY/ON button (15)**  
Press to turn on or standby the PD-10AE.
- 2. Disc tray (16)**  
The CD is loaded here.
- 3. Open/Close button (16)**  
Press to open and close the disc tray.
- 4. Play button (16 – 19, 21, 22)**  
Press to start playback.
- 5. Pause button (16, 17)**  
Press to pause playback.
- 6. Stop button (16 – 19, 24)**  
Press to stop playback.
- 7. Remote control sensor (11)**  
Receives control signals from the remote controller.
- 8. Display (8)**  
See next page.
- 9. [ ]/[ ] buttons (16 – 19, 21)**  
Press to select the previous or next track.  
Hold down the buttons to fast-reverse or fast-forward during playback.

### Display

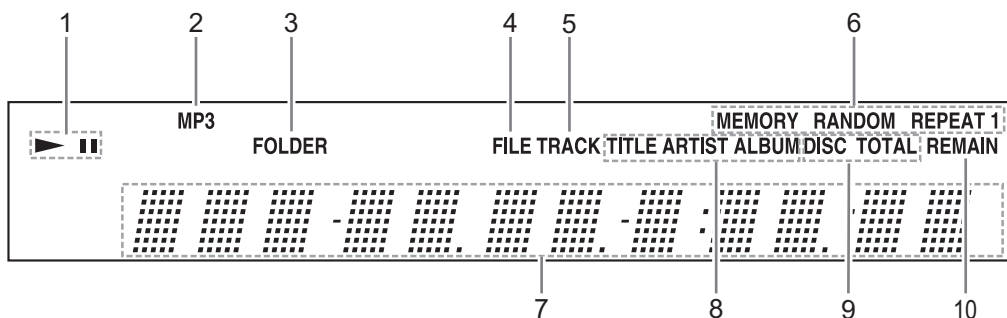

**1. ►|| indicators**

The ► indicator lights up for playback.  
The || indicator lights up while playback is paused.

**2. MP3 indicator**

Lights up when an MP3 CD is loaded.

**3. FOLDER indicator**

Lights up when folder playback is selected.

**4. FILE indicator**

Lights up when an MP3 file number is being displayed.

**5. TRACK indicator**

Lights up when a CD track number is being displayed.

**6. Playback mode indicators**

**MEMORY** lights up when memory playback is selected.

**RANDOM** lights up when random playback is selected.

**REPEAT** lights up when repeat playback is selected for all tracks.

**REPEAT 1** lights up when repeat playback is selected for one track.

**7. Message area**

Various information is displayed here.

**8. TITLE, ARTIST, and ALBUM indicators**

**TITLE** lights up when the title (ID3 tag) of an MP3 track is being displayed.

**ARTIST** lights up when the artist name from an MP3 track (ID3 tag) is being displayed.

**ALBUM** lights up when the album name from an MP3 track (ID3 tag) is being displayed.

**9. DISC, TOTAL indicators**

These indicators light up when the total disc time or track time is being displayed.

**10. REMAIN indicator**

This indicator lights up when the remaining disc time or track time is being displayed.



### Rear Panel

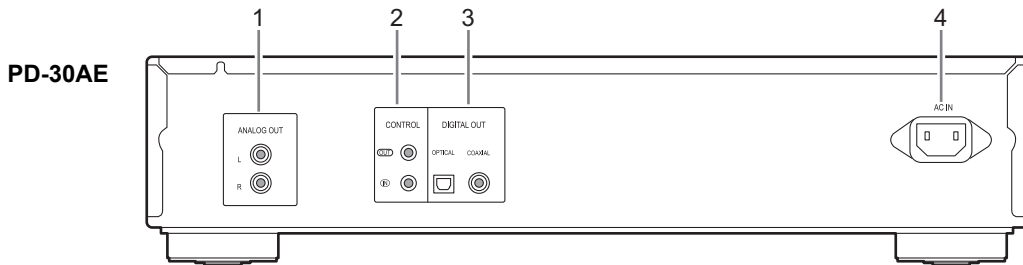

**1. ANALOG OUT jacks (13)**

These analog audio outputs can be connected to an amplifier's analog inputs by using the supplied audio cable.

**2. CONTROL IN/OUT jacks (14)**

By connecting Pioneer brand components with control jacks, you can centralize control of the devices using the remote controller of this unit.

**3. DIGITAL OUT OPTICAL/ COAXIAL jacks**

These two digital audio outputs can be connected to a digital audio input on an amplifier or recorder.

**4. AC IN (14)**

The supplied power cord is connected.

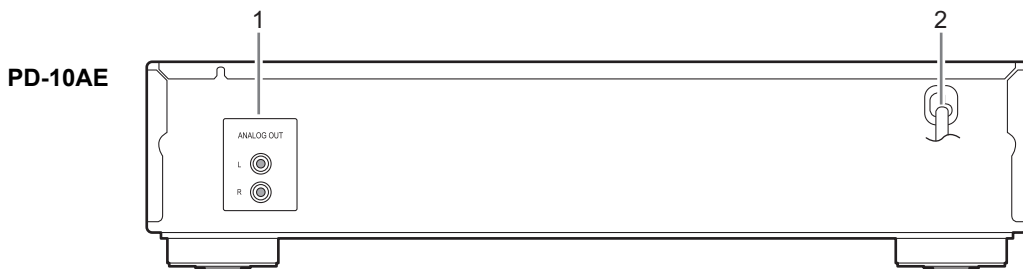

**1. ANALOG OUT jacks (13, 14)**

These analog audio outputs can be connected to an amplifier's analog inputs by using the supplied audio cable.

**2. Power code (14)**

## Getting to Know the CD Player-Continued

### Remote Controller

The page numbers in parentheses show where you can find the main explanation for each item.

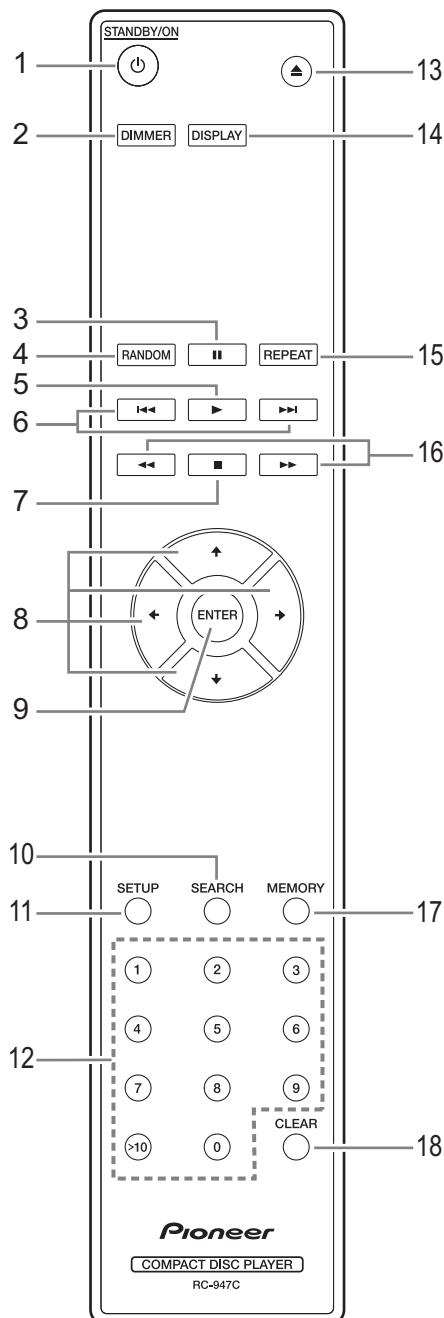

- 1. STANDBY/ON button (15)**  
Press to turn on or standby the PD-30AE/PD-10AE.
- 2. DIMMER button (15)**  
Press to adjust the display brightness.
- 3. Pause button (16, 17)**  
Press to pause playback.
- 4. RANDOM button (21)**  
Select the Random playback mode.
- 5. Play button (16 – 19, 21, 22)**  
Press to start playback.
- 6. / buttons (16, 17, 19, 21)**  
Press to select the previous or next track.
- 7. Stop button (16, 18, 19, 24)**  
Press to stop playback.
- 8. /// buttons (15, 18, 19, 21, 22, 24)**  
Press the Arrow buttons to configure various settings, and then press the ENTER button to set them.  
These buttons can be also used to select a track.
- 9. ENTER button (15, 19, 21 – 24)**  
Press to set a selected preference.
- 10. SEARCH button (19)**  
For MP3 CDs, this button is used to search and select a file number or a folder number.
- 11. SETUP button (24)**  
Press to access various settings.
- 12. Number buttons (17, 19)**  
Use to enter track numbers.
- 13. Open/Close button (16)**  
Press to open and close the disc tray.
- 14. DISPLAY button (17, 20)**  
Press to change the displayed information.
- 15. REPEAT button (23)**  
Select the repeat playback or 1-repeat playback mode.
- 16. / buttons (17, 21)**  
Hold down to fast-reverse or fast-forward during playback.
- 17. MEMORY button (21, 22)**  
Select the Memory playback mode.
- 18. CLEAR button (21)**  
Use to clear any numbers that have been entered during numeric input. When making a memory setting, the selected track is erased.

### Installing the Batteries

- 1 To open the battery compartment, press the small hollow and slide open the cover.

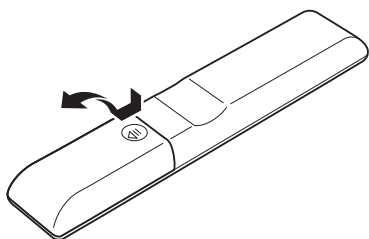

- 2 Insert two batteries (R03/AAA) into the compartment.

Carefully follow the polarity diagram (positive (+) and negative (-) symbols) inside the battery compartment.

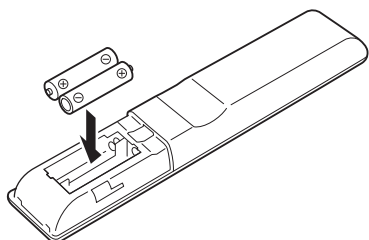

- 3 Replace the cover and slide it shut.

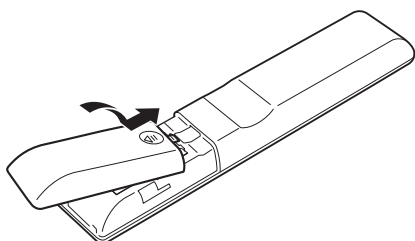

#### Notes:

- If the remote controller doesn't work reliably, try replacing the batteries.
- Don't mix new and old batteries or different types of batteries.
- If you intend not to use the remote controller for a long time, remove the batteries to prevent damage from leakage or corrosion.
- Expired batteries should be removed as soon as possible to prevent damage from leakage or corrosion.

### Aiming the Remote Controller

When you operate the remote controller, point it at the CD Player's remote control sensor, as shown below.

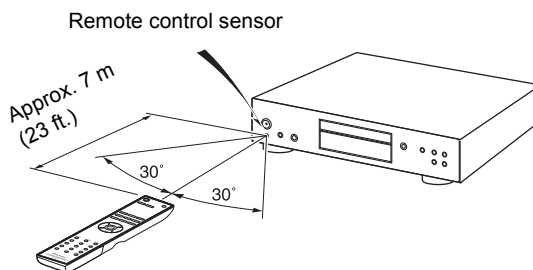

#### Notes:

- The remote controller may not work reliably if the CD Player is subjected to bright light, such as direct sunlight or inverter-type fluorescent lights. Keep this in mind when installing.
- If another remote controller of the same type is used in the same room, or the CD Player is installed close to equipment that uses infrared rays, the remote controller may not work reliably.
- Don't put anything, such as a book, on the remote controller because the buttons may be pressed inadvertently, thereby draining the batteries.
- The remote controller may not work reliably if the CD Player is installed in a rack behind colored glass doors. Keep this in mind when installing.
- The remote controller will not work if there's an obstacle between it and CD Player's remote control sensor.

# Disc Notes

## Precautions for Playback

Compact discs (CDs) with the following logo on the label surface can be used.

Do not use discs designed for purposes other than audio, such as CD-ROMs for PC use. Abnormal noise could damage the speakers or amplifier.



- \* This CD player supports CD-R and CD-RW discs. Note that some discs may not play back because of the disc characteristics, scratches, contamination or the recording state. A disc recorded with an audio CD recorder will not play back unless it is finalized.

Never use discs which have an unusual shape (such as hearts or octagons). These types of discs could jam and damage the CD player.



## CD Playback with Copy-control Function

Some audio CDs with copy-control functionality do not comply with official CD standards. These are special discs and cannot be played with this CD player.

## Playback of MP3 Discs

MP3 files recorded on a CD-R/CD-RW can be played with this CD player.

- Use discs which have been recorded following the ISO9660 Level 2 file system. (The supported directory depth is eight levels, the same as ISO9660 Level 1)
- Discs recorded with the hierarchical file system (HFS) cannot be played.
- Up to 99 folders (including the root folder), and up to 499 files (including root) and files can be recognized and played.

### Notes:

- A disc recorded with a recorder or personal computer may not play in some cases. (Cause: Disc's characteristics, damaged or dirty disc, dirt on player's lens, dew condensation, etc.)
- A disc recorded on a personal computer may not play because of the application settings or environment. Record the disc with the proper format. (Contact the application maker for details.)
- A disc with insufficient storage capacity may not play back properly.

## Playback of MP3 Discs

- Only MP3 files with the extension “.MP3” or “.mp3” are supported.
- This CD player supports files recorded in MPEG 1 Audio Layer 3 (32-320kbps), with a sampling frequency of 32/44.1/48 kHz.
- Variable bitrates (VBR) between 32kbps and 320kbps are supported. The time information during VBR playback may not display correctly.

## Handling Discs

Hold discs by the edge, or by the center hole and edge. Avoid touching the playback surface (surface with nothing printed on it).

Label surface  
(printed surface)

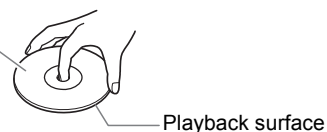

Do not attach paper or stickers, or write on the playback or label surface of the disc. Take care not to scratch or damage the disc.

## Precautions for Rental Discs

Do not use discs with residue from cellophane tape, rental discs with labels which are peeling off, or discs with decorative labels. This type of disc could get stuck in the CD player, or could damage the CD player.

## Precautions for Inkjet Printable Discs

Do not leave a CD-R/CD-RW having a label printed with an inkjet printer in the CD player for a long time. The disc could get stuck in the CD player, or could damage the CD player.

Remove the disc from the CD player when not being played, and store it in a case. A freshly printed disc will stick easily, and should not be played immediately.

## Caring for Discs

If the disc is dirty, the PD-30AE/PD-10AE will have a hard time reading signals, and the audio quality may drop. If the disc is dirty, gently wipe off fingerprints and dust with a soft cloth. Lightly wipe from the center outwards.

To remove stubborn dust or dirt, wipe the disc with a soft cloth dampened with water, and then dry it with a dry cloth. Do not use cleaning spray for analog records or antistatic agents, etc. Never use volatile chemicals such as benzine or paint thinner as they can impregnate the disc surface.

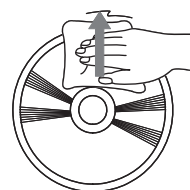

# Connecting the CD Player

## Audio Connections

- Before making any connections, read the manuals supplied with your other components.
- Don't connect the power cord until you've completed and double-checked all connections.
- We will not accept responsibility for damage arising from the connection of equipment manufactured by other companies.

### Connection Color Coding

RCA-type audio connections are usually color-coded: red and white. Use red plugs to connect right-channel audio inputs and outputs (typically labeled "R"). Use white plugs to connect left-channel audio inputs and outputs (typically labeled "L").



- Push plugs in all the way to make good connections (loose connections can cause noise or malfunctions).

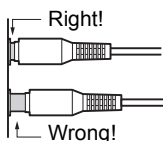

- To prevent interference, keep audio cables away from power cords and speaker cables.

### Optical/Coaxial Digital Jack (PD-30AE only)

The unit supports 16 bit, 44.1 kHz PCM signal digital output.

The PD-30AE's optical digital jack has a shutter-type cover that opens when an optical plug is inserted and closes when it's removed. Push the plug in all the way.

**Caution:** To avoid damaging the shutter, hold the optical plug straight when inserting and removing.

#### Note:

Do not put anything on top of the PD-30AE/PD-10AE, as it may interfere with proper ventilation.

**Disconnect the power cord before making any connections!**

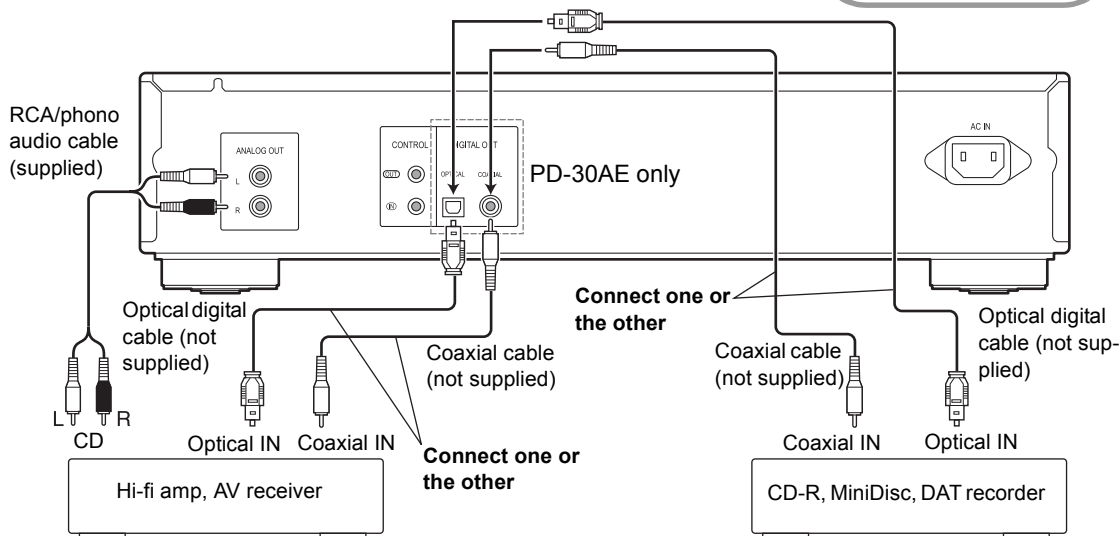

## Connecting the CD Player-Continued

### Using centralized control with other Pioneer components (PD-30AE only)

By connecting Pioneer brand components with control jacks with monaural miniplug cables (without resistors), you can centralize control of the devices using the remote controller of this unit. This also allows remote control of components not equipped with a remote sensor, or installed in places where the component's remote sensor cannot be accessed.

#### Note:

- When connecting the CONTROL IN/OUT jacks, supplied analog audio cables must also be used to make analog connections. Merely connecting the CONTROL IN/OUT jacks alone will not allow proper system control.
- When a monaural miniplug cable is connected to the PD-30AE's CONTROL IN jack, the unit cannot be controlled by pointing the remote control at the PD-30AE (the remote sensor is automatically disabled).

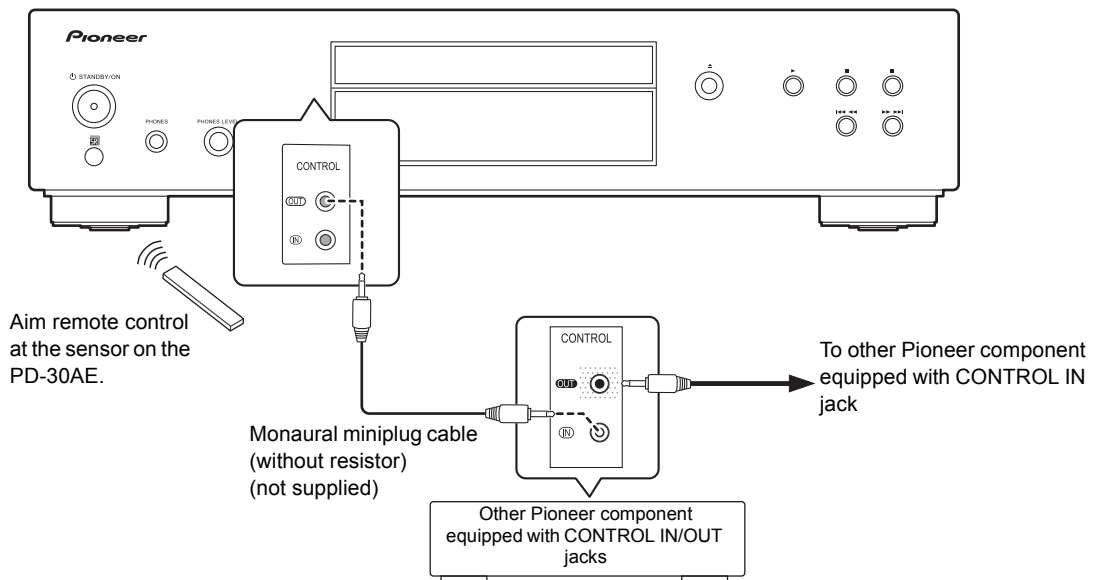

## Connecting the Power Cord



Before connecting the power cord, connect all of the other components.

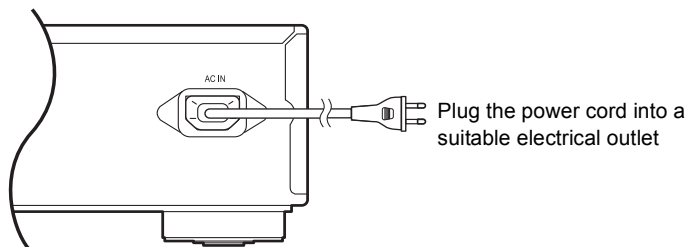

# Basic Operation

## Turning On CD Player

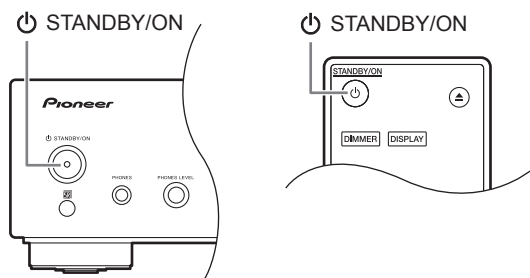

To turn on the CD Player, press the [STANDBY/ON] button on the unit or the remote controller. Press the [STANDBY/ON] button again to set the CD Player to Standby.

## Setting Auto Standby (ASb)

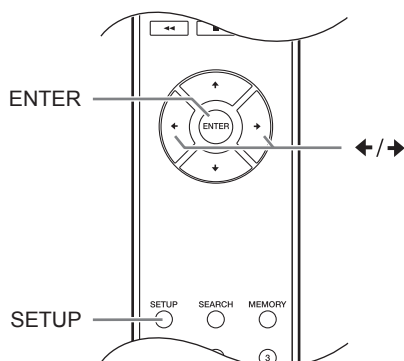

You can specify that if the CD Player is left stopped for 30 minutes, the power will automatically turn off, placing the unit in Standby mode (Auto Standby function).

### On the North American model:

The default setting is "Off".

### On the European model:

The default setting is "On".

Make settings for this function while playback is stopped.

- 1 Press the [SETUP] button.
- 2 Use the [←] or [→] button to display "ASb"; then press the [ENTER] button.
- 3 Use the [←] or [→] button to switch "Off" or "On"; then press the [ENTER] button.
- 4 "COMPLETE" appears on the display.

### Note:

If playback is paused, the power will remain on even after 30 minutes have elapsed; the Auto Standby function will not operate.

## Changing the Display Brightness

Press the remote controller's [DIMMER] button repeatedly to select the following options:



## Using Headphones

Turn down the volume, then connect your stereo headphones to the [PHONES] jack.

You can adjust the volume by using the [PHONES LEVEL] knob.

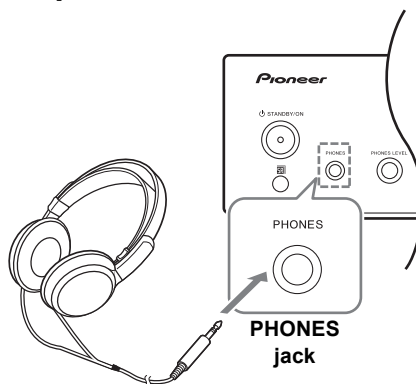

# Disc Playback

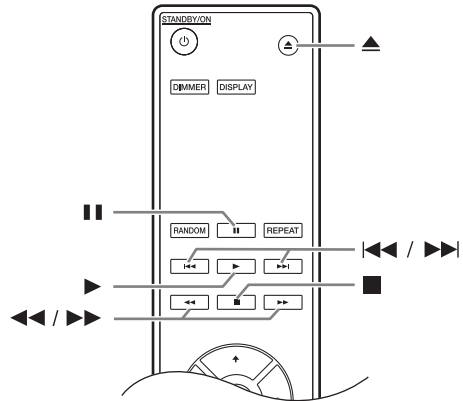
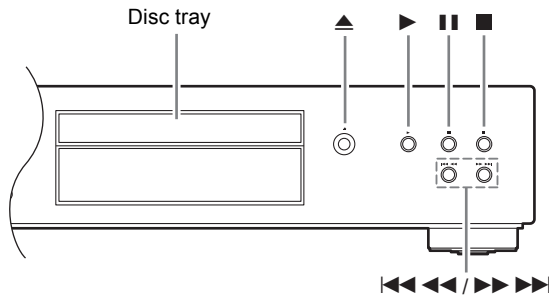

- 1** Press the Open/Close [] button to open the disc tray.
- 2** Place the CD on the tray with the label-side facing up.  
If you're playing an 8 cm CD, place it in the center of the tray.
- 3** To start playback, press the Play [] button.  
The disc tray closes and playback starts.

The contents of the disc are displayed when you use the Open/Close [] button to load a disc and when you press the Stop [] button during playback.  
Example displays:

#### • Audio CD

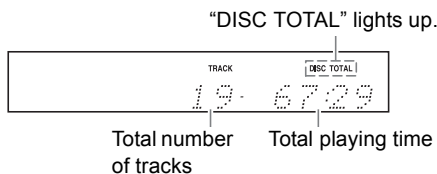

#### • MP3 Discs

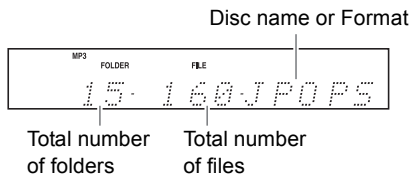

## Selecting Tracks

To return to the beginning of the track that's currently playing or paused, press the Previous [] button.  
(Remote controller: [])

Press the Previous [] button repeatedly to select earlier tracks. (Remote controller: [])

Press the Next [] button repeatedly to select subsequent tracks. (Remote controller: [])

#### • To Fast-Forward or Fast-Reverse

During playback or while playback is paused, hold down the [] button on the CD Player to fast-forward or the [] button on the CD Player to fast-reverse.

If you use the remote controller, use the []/ [] buttons.

On MP3 CDs, fast-reverse only works within the MP3 file that's currently playing.

#### • To Pause Playback

Press the Pause [] button. The Pause [] indicator appears.

To resume playback, press the Play [] or Pause [] button again.

#### • To Stop Playback

Press the Stop [] button.

#### • To Eject the CD

Press the Open/Close [] button to open the disc tray.

### Notes:

#### - MP3 CDs -

If you press the [] button during playback or while playback is paused, the beginning of the current file is selected.

If you select a file while playback is stopped, press the Play [] button to start playback.

You can select MP3 files in other folders by using the []/ [] buttons.



# Disc Playback-Continued

## Using the Remote Controller

**[||]**  
Press to pause playback

**[▶]**  
Press to start playback

**[◀◀]/[▶▶]**  
**Press to select tracks**

- Press the Previous [◀◀] button to locate the beginning of the currently playing or paused track. Press it repeatedly to select earlier tracks.
- Press the Next [▶▶] button repeatedly to select subsequent tracks.

For MP3 files, you can select files in other folders.

**[■]**  
Press to stop playback

**[DISPLAY]**  
Press repeatedly to display CD information  
See below for details.

**[◀◀]/[▶▶]**  
**Press to fast-forward or fast-reverse**

During playback or while playback is paused, press and hold the Fast Forward [▶▶] button to fast-forward, or the Fast Reverse [◀◀] button to fast-reverse.

**Use the number buttons as shown in the examples below to select tracks.**

To select:	Press:
Track #8	[8]
Track #10	[>10] [1] [0]
Track #34	[>10] [3] [4]

[>10] Used to enter numbers over 9.  
With MP3 CDs, you can select files in the current folder using these buttons.

## Displaying CD Information

Press the remote controller's [DISPLAY] button (repeatedly) to show the following CD information.

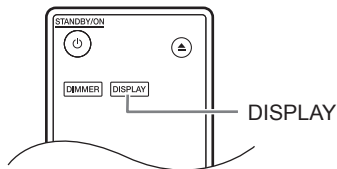

### While Playback is Stopped

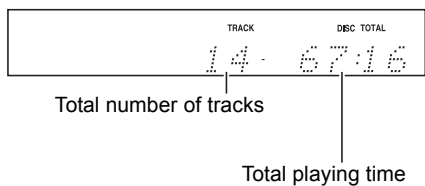

### During Playback or While Playback is Paused

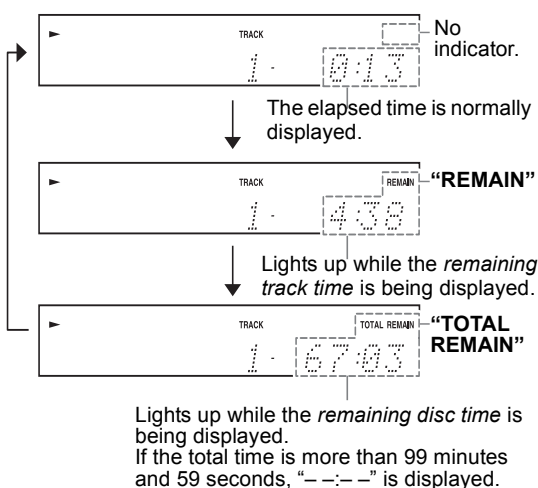

See page 20 for details on displaying MP3 information.

## Selecting Files (MP3 CDs)

For MP3 CDs, files (MP3 files) may be organized in a hierarchy, with folders containing files and subfolders, as shown below.

- In this manual, MP3 files are referred to as files. Likewise, folders (directories) are referred to as folders.

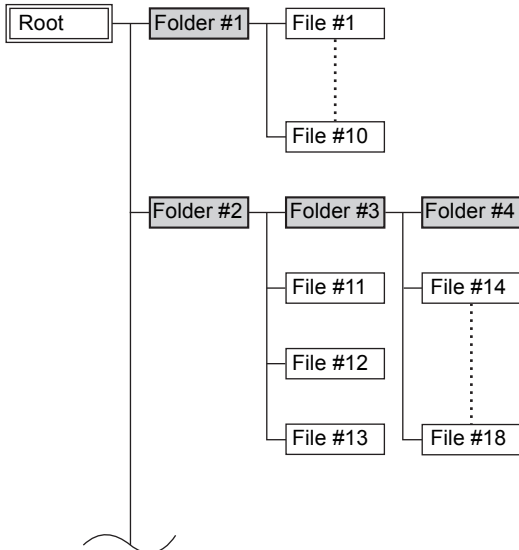

If you don't select a specific MP3 file or folder for playback, all of the MP3 files on the CD will be played in numerical order starting with file #1.

On this CD Player, there are two modes for selecting files (MP3 files): **Navigation mode and All Folder mode.**

In Navigation mode, you can select files (MP3 files) by navigating through the folder hierarchy, moving in and out of folders and subfolders.

In All Folder mode, all folders appear at the same level, making it easy to select folders regardless of the hierarchy.

**While playback is stopped, press the remote controller's [■] or [▼] button to enter Navigation mode, the [■] or [▲] button to enter All Folder mode. If you use the CD Player's button, press the [■] button to enter Navigation mode, press and hold the [■] button to enter All Folder mode.**

You can change the way in which these buttons change the playback mode. This lets you disable the file selection methods described in Navigation mode or All Folder mode. (See "STOP KEY" in "Setting MP3 Preferences" on page 25.)

## Selecting Files in Navigation Mode

In Navigation mode, you can select files by navigating through the folder hierarchy. This mode can only be used while playback is stopped.

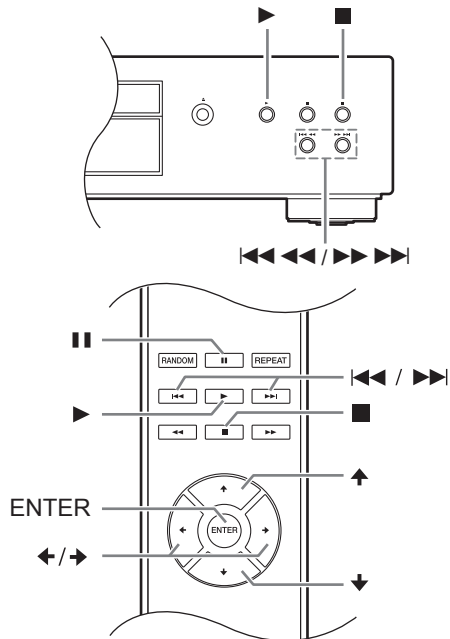

- 1 While playback is stopped, press the [▼] or [■] button. (front panel: [■])

The compact disc player enters Navigation mode and "[ROOT]" appears on the display.

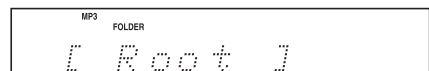

- 2 Press the [▼] or [ENTER] button (front panel: [▶]).

The first folder name in ROOT appears on the display. If the disc contains no folders, the first file name appears.

- 3 Use the [←]/[→] or [◀◀]/[▶▶] buttons to select other folders and files at the same level. (front panel: [◀◀◀◀]/[▶▶▶▶])

To move up a level, press the [▲] or [■] button (front panel: [■]).

Folders that don't contain files or subfolders can't be selected.

- 4 Press the [ENTER] or [▼] button to move down a level (front panel: [▶]).

- 5 Use the [←]/[→] or [◀◀]/[▶▶] buttons to select a file in the folder. (front panel: [◀◀◀◀]/[▶▶▶▶])

## Disc Playback-Continued

- 6 Press the [ENTER] or [▶] button.**  
Playback will start with the specified file or folder and continue until all of the files on the disc have been played.

To cancel the procedure at any point, press the [■].

**Note:**

- The behavior of the [■] on the CD Player can be set from "STOP KEY" preference (page 25).

### Selecting Files in All Folder Mode

In All Folder mode, you don't have to navigate the folder hierarchy because all folders that contain files appear at the same level. This mode can only be used while playback is stopped.

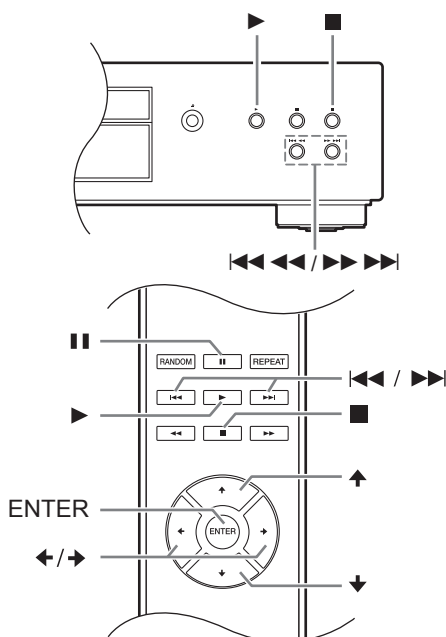

- 1 While playback is stopped, press the [▲] or [■] button (front panel: press and hold the [■]).**  
The CD Player enters All Folder mode, and "1" appears on the display.

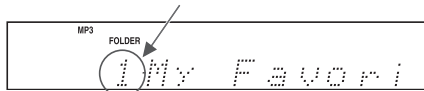

- 2 Use the [◀]/[▶] or [◀◀]/[▶▶] buttons to select the other folders. (front panel: [◀◀◀◀]/[▶▶▶▶])**  
You can select any folder that contains files.

- 3 Press the [▼] button (front panel: [▶]).**  
The first file name inside the folder appears. Use the [◀]/[▶] or [◀◀]/[▶▶] buttons to select the files within the folder.

To select another folder, press the [■] button again (front panel: [■]), and then use the [◀◀]/[▶▶] buttons to select it (front panel: [◀◀◀◀]/[▶▶▶▶]).

- 4 Press the [ENTER] or [▶] button to start playback.**

Playback will start with the specified file or folder and continue until all of the file on the disc have been played.

To cancel the procedure at any point, press the [■].

**■ To Select Folders and Files by Number**

- 1. Use the number buttons as shown in the examples below to enter folder/file numbers.**

To select:	Press:
Folder/File #8	8
Folder/File #10	>10 1 0
Folder/File #34	>10 3 4

⊖ Used to enter numbers over 9.

- 2. Playback starts.** When you enter folder number, playback will start from the first file in the selected folder. If a folder contains more than 99 files, single and double-digit file numbers must be preceded by zeros. For example, to specify file #8, press >10, 0, 0, and 8. To specify file #34, press >10, 0, 3, and 4. To specify file #134, press >10, 1, 3, and 4.

**Note:**

- The behavior of [■] on the CD Player can be set from "STOP KEY" preference (page 25).

### Selecting a Folder during Playback (Search Mode)

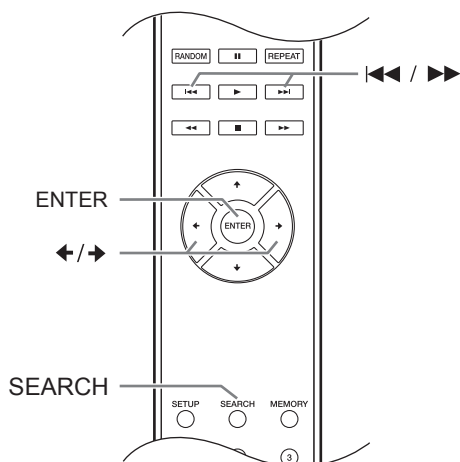

- 1 Press the [SEARCH] button.**  
The display blinks.

## Disc Playback-Continued

- To select the previous folder, press the Previous [◀] button.  
To select the next folder, press the Next [▶] button.

- Press the [ENTER] button to display the file name, and start playback the selected file.

- Use the Previous [◀◀] and Next [▶▶] buttons to select the previous or next file, and start playback.

### Note:

The [SEARCH] button cannot be used during "Random Playback" or "Memory Playback".

## Displaying MP3 Information

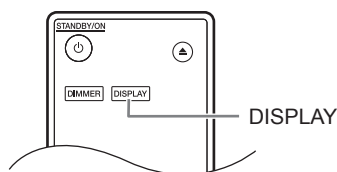

You can display various information about the MP3 file currently playing, including ID3 tags such as title name, artist name, and album name.

During playback, press the [DISPLAY] button repeatedly to display the following MP3 information.

**Elapsed file time:** The length of time that the current file has been playing (default display). If the elapsed time is more than 99 minutes and 59 seconds, "--:--" is displayed.

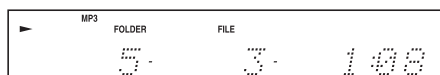

**File name:** Name of the current file.



**Folder name:** Name of the current folder.

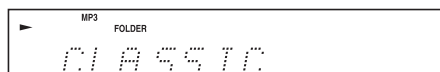

**Title:** Title of the current file (if ID3 tag is present). When there is no ID3 tag, "TITLE-NO DATA" appears.

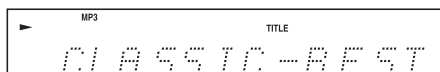

**Artist name:** Name of the artist (if ID3 tag is present).

When there is no ID3 tag, "ARTIST-NO DATA" appears.

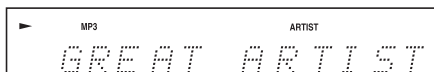

**Album name:** Name of the album (if ID3 tag is present). When there is no ID3 tag, "ALBUM-NO DATA" appears.

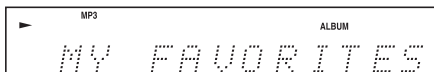

**Sampling rate and bit rate:** Sampling rate and bit rate of the current file.

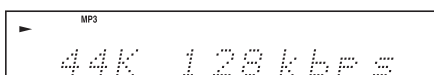

### Notes:

- To display the disc name, press the [DISPLAY] button while playback is stopped.
- If a file or folder name contains any characters that cannot be displayed, an underscore will appear in place of those characters. Alternatively, you can set the CD Player so that names containing such characters are displayed as "FILE n" or "FOLDER n," "n" being the file or folder number (see "BAD NAME" on page 24).

# Various Playback Modes

You can select the following playback modes:

- Random playback
- Memory playback
- Repeat playback

## Random Playback

With random playback, all of the files on the disc are played in random order.

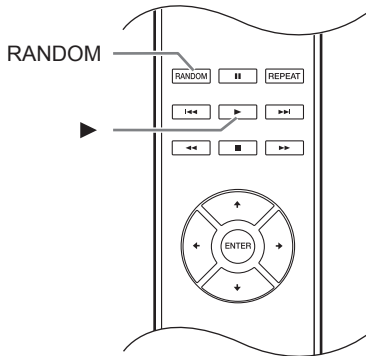

- 1 While playback is stopped, press the [RANDOM] button; the RANDOM indicator appears.

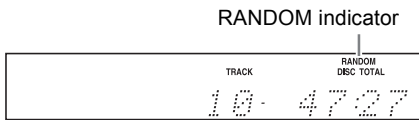

- 2 To start random playback, press the Play [▶] button.

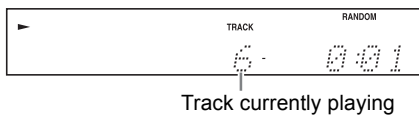

### ■ To Cancel Random Playback

- Stop playback, then press the [RANDOM] button to change the playback mode. The RANDOM indicator disappears, and random playback is cancelled.
- Random playback is cancelled when the disc is ejected.

## Memory Playback (For Audio CDs)

In memory playback, you can create a playlist of up to 25 files.

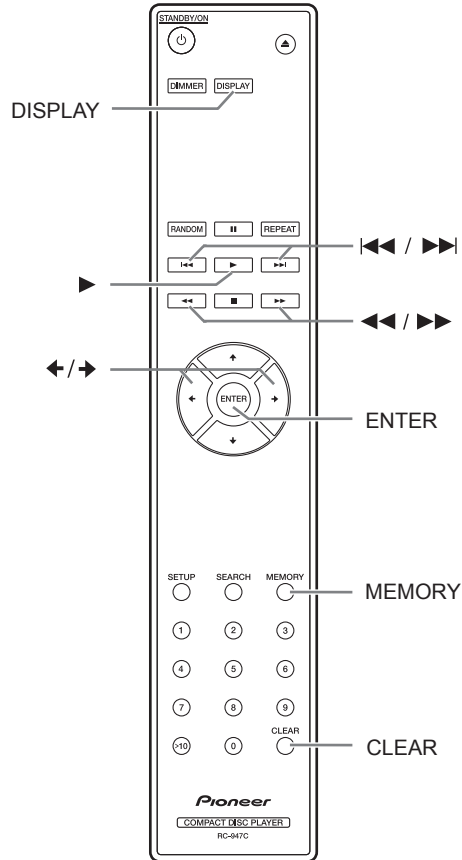

Memory playback can be set only when playback is stopped.

- 1 Press the [MEMORY] button; the MEMORY indicator appears.

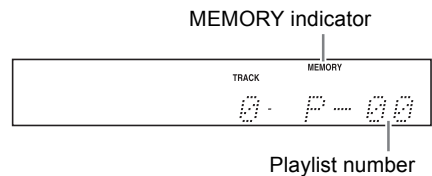

## Various Playback Modes-Continued

- 2 Use the Previous and Next [◀]/[▶] buttons to select the first file you want to add to the playlist, and then press [ENTER] button.**

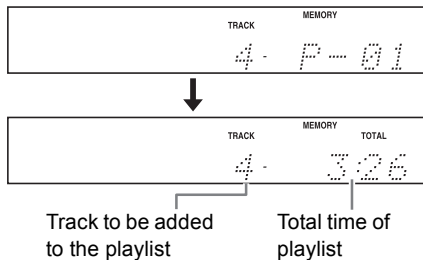

Repeat this step to add additional files to the playlist. Alternatively, you can use the number buttons on the remote controller to select files instead of the Previous and Next [◀]/[▶] and the [ENTER] buttons.

**Notes:**

- If the total playing time is more than 99 minutes and 59 seconds, “--:--” appears.
- You can add up to 25 files to the playlist. If you try to add more, the message “MEM FULL” appears.

- 3 To start memory playback, press the [ENTER] button. Memory playback starts.** Alternatively, you can start playback with the Play [▶] button.

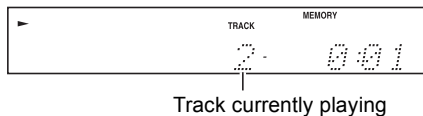

**■To Change the Display**

While creating a playlist for memory playback, you can press the [DISPLAY] button to change the display information as follows:



**■To Select Other Files During Memory Playback**

Use the Previous and Next [◀◀]/[▶▶] buttons.

**■To Check What’s on the Playlist**

While playback is stopped, use the Fast Reverse and Fast Forward [◀◀]/[▶▶] buttons to scroll through the playlist.

**■To Remove Files from the Playlist**

- While memory playback is stopped, press the [CLEAR] button. Each press removes the last file from the playlist.
- The playlist is deleted when you change the playback mode (i.e., when you press the [MEMORY] button after stopping playback).

**■To Cancel Memory Playback**

- Stop playback, then press the [MEMORY] button to change the playback mode. The MEMORY indicator disappears, and memory playback is cancelled.
- Memory playback is cancelled when the disc is ejected.

**Memory Playback (For MP3 CDs)**

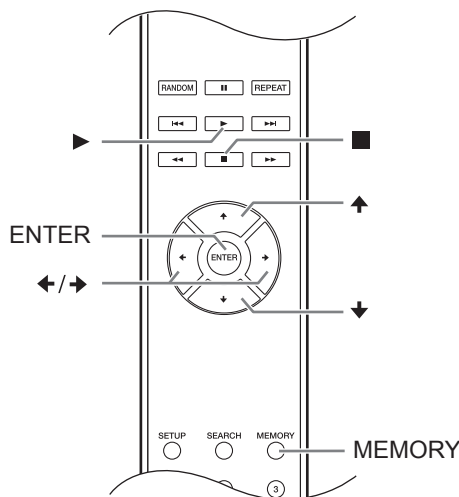

**Memory Playback in Navigation Mode**

Memory playback can be set only when playback is stopped.

- 1 Press the [MEMORY] button; the MEMORY indicator appears.**

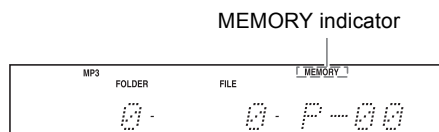

- 2 Press the [■] or [▼] button.** The CD Player enters Navigation mode and “ROOT” appears on the display.

- 3 Press the [ENTER] button.** The first folder name in ROOT appears on the display.

- 4 Use the [◀]/[▶] buttons to select other folders and files at the same level.** Folders that don’t contain files or subfolders can’t be selected. Repeat steps 3 and 4 to select the files and subfolders in that folder.

- 5 Press the [MP3] button.** The first item is memorized in the playlist.

## Various Playback Modes-Continued

### 6 Use the [▲]/[◀]/[▶] buttons to continue selecting other items for memory playback.

To move up a level, press the [▲] button.

To continue selecting items for memory playback, repeat steps 4 and 5.

To memorize other items of the same folder in the playlist, use the [◀]/[▶] buttons to select items, then press the [ENTER] button.

### 7 Press the Play [▶] button.

Memory playback starts.

### Memory Playback in All Folder Mode

Memory playback can be set only when playback is stopped.

### 1 Press the [MEMORY] button; the MEMORY indicator appears.

### 2 Press the [||] or [▲] button.

The CD Player enters All Folder mode and “1-” appears on the display.

### 3 Use the [◀]/[▶] buttons to select the folder.

### 4 Press the [ENTER] button.

### 5 Use the [◀]/[▶] buttons to select the file.

### 6 Press the [ENTER] button.

The first file is memorized in the playlist.

### 7 Press the [▲] button, then repeat steps 3 to 6.

To memorize other files of the same folder in the playlist, repeat steps 5 to 6.

### 8 Press the Play [▶] button.

Memory playback starts.

#### ■To Change the Display

While creating a playlist for memory playback, you can press the [DISPLAY] button to change the display information as follows:

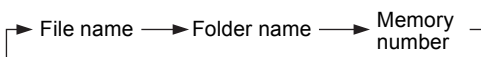

## Repeat Playback

In repeat playback, you can play an entire CD repeatedly, play one track repeatedly, or combine it with memory playback to play the playlist repeatedly, or random playback to play all of the tracks on the disc in random order repeatedly.

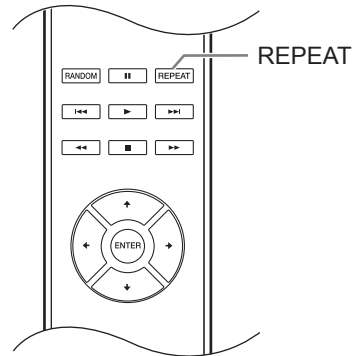

Press the [REPEAT] button; the “REPEAT ALL” or “REPEAT1” indicator appears.

Repeat-1 playback can't be combined with memory playback or random playback.

#### ■To Cancel Repeat Playback

- Press the [REPEAT] button repeatedly until “REPEAT OFF” appears. (The REPEAT indicator disappears.)
- Repeat playback is cancelled when the disc is ejected.

# Setting for MP3

## Setting MP3 Preferences

The MP3 preferences let you change the way MP3 file information is displayed and the way MP3 CDs are played.

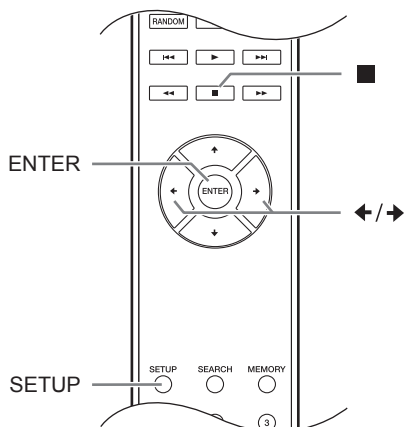

The MP3 preferences can be set only when playback is stopped.

- 1 Press the [SETUP] button.
- 2 Use the [←]/[→] buttons to select the preference you want to change.

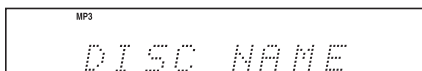

The preferences are explained in the next column.

- 3 Press the [ENTER] button.
- 4 Use the [←]/[→] buttons to select the preference's options.  
To cancel the procedure at any point, press the [■] button.
- 5 Press the [ENTER] button.  
When the preference has been set, "COMPLETE" appears on the display.

### Preferences

Below, the name of each preference is followed by its options in parentheses, with the default option in bold.

#### ■ DISC NAME (Display/Not)

This preference determines whether the disc name is displayed when an MP3 disc is loaded.

#### ■ FILE NAME (Scroll/Not)

This preference determines whether the file name scrolls across the display when an MP3 file is selected.

#### ■ FOLDER NAME (Scroll/Not)

This preference determines whether the folder name scrolls across the display when an MP3 folder is selected.

In Navigation mode (see page 18), the folder name scrolls across the display regardless of this setting.

#### ■ BAD NAME (Replace/Not)

This preference determines whether file and folder names that contain undisplayable characters are replaced with "File n" or "Folder n," "n" being the file or folder number. When set to Not Replace, displayable characters are displayed and underscore characters are used in place of any undisplayable characters.

For ID3 tags, underscore characters are used in place of undisplayable characters regardless of this preference.

#### Note:

File and folder names are scrolled in Navigation mode (page 18) regardless of the FILE NAME and FOLDER NAME preferences.

#### ■ ID3 VER. 1 (Read/Not Read)

This preference determines whether version 1.0/1.1 tags are read and displayed. When set to Not Read, version 1.0/1.1 tags are not displayed.

#### ■ ID3 VER. 2 (Read/Not Read)

This preference determines whether version 2.2/2.3/2.4 tags are read and displayed. When set to Not Read, version 2.2/2.3/2.4 ID3 tags are not displayed.

#### ■ CD EXTRA (Audio/MP3)

This preference applies to CD Extra discs and determines whether music in the audio session or MP3 files in the data session are played.

#### ■ JOLIET (Use SVD/ISO9660)

This preference applies to MP3 discs in Joliet format and determines whether the CD-Player reads the SVD data or treats the disc as an ISO 9660 disc. Normally, this preference doesn't need to be changed.

SVD (Supplementary Volume Descriptor) supports long file and folder names and characters other than letters and numbers. Some CD burning software refers to the Joliet format as "Windows format."

#### ■ HIDE NUMBER (Disable/Enable)

This preference determines whether the numbers at the beginning of file and folder names are hidden.

When you create an MP3 CD on a personal computer, you cannot normally determine the playback order of the files. However, if you number the MP3 files in order, starting with 01, 02, 03, and so on, they will play in that order. If you don't want these numbers to appear on the display, choose Enable.

The following table shows a few examples of numbered file and folder names and how they will appear with the Disable and Enable options.



## Setting for MP3-Continued

---

File/folder name	Disable	Enable
01 Pops	01 Pops	Pops
10-Rock	10-Rock	Rock
16_Jazz	16_Jazz	Jazz
21st Century	21st Century	21st Century
05-07-20 Album	05-07-20 Album	Album

### ■ STOP KEY (All Folder/Navigation/Disable)

This preference determines how the Stop [■] button on the CD Player works.

When the ALL Folder option is selected, pressing the Stop [■] button once selects All Folder mode.

When the Navigation option is selected, pressing the Stop [■] button once selects Navigation mode.

When the Disable option is selected, the CD Player does not enter Navigation or All Folder mode when you press the Stop [■] button.

### ■ ASb (On/Off)

Please refer to “Setting Auto Standby (ASb)” (page 15) for details of the procedure.

#### **On the North American model:**

The default setting is “Off”.

#### **On the European model:**

The default setting is “On”.

# Troubleshooting

---

If you have any trouble using the CD Player, look for a solution in this section.

If you can't resolve the issue yourself, try resetting the CD Player before contacting the dealer from whom you purchased this unit.

**To reset the CD Player to its factory defaults, turn it on and, while holding down the [▶▶▶] button, press the [■] button. "Clear" will appear on the display.**

**Note that resetting the CD Player will delete your custom settings.**

## Power

### Can't turn on the PD-30AE/PD-10AE.

- Make sure that the power cord is properly plugged into the wall outlet (page 14).
- Unplug the power cord from the wall outlet, wait five seconds or more, then plug it in again.

## Audio

### There's no sound.

- The PD-30AE/PD-10AE is not connected properly. Check all connections and correct as necessary.
- The wrong input source is selected on your amplifier. Check your amplifier's input source setting. Refer to your amplifier's manual.

## CD

### Can't play a CD.

- The disc is upside down. Load the disc with the label-side facing up (page 16).
- The disc is dirty. Remove the disc and clean it (page 12).
- Condensation has formed inside the PD-30AE/PD-10AE. Unplug the power cord and leave the unit for two to three hours in the room temperature until the condensation has evaporated.
- The disc is nonstandard. See "Disc Notes" on page 12.

### CD playback skips.

- Install the PD-30AE/PD-10AE in a location that is free of vibration.
- The disc is dirty. Remove the disc and clean it (page 12).
- The disc is very scratched. Replace the disc.

### Can't enter track numbers for memory playback.

- No such track on the CD. Enter another number (page 22).

### It takes a long time to locate certain tracks.

- The disc is dirty. Remove the disc and clean it (page 12).
- The disc is very scratched. Replace the disc.

## SETUP

### Can't access the SETUP menu.

- If any track has been selected even when the PD-30AE/PD-10AE is stopped, you must place it into the full stop state by pressing the [■] button before you can view all the SETUP menus.

## Remote Controller

### The remote controller does not work.

- There are no batteries in the remote controller. Install new batteries (page 11).
- The batteries are expired. Replace with new batteries (page 11).
- The batteries are installed incorrectly. Check the batteries and correct as necessary (page 11).

## Troubleshooting-Continued

---

- You're not pointing the remote controller at the PD-30AE/PD-10AE's remote sensor. Point the remote controller at the PD-30AE/PD-10AE's remote sensor (page 11).
- You're too far away from the PD-30AE/PD-10AE. Move the remote controller closer to the PD-30AE/PD-10AE (page 11). The remote controller has a range of approximately 5 meters (16 ft.).
- A strong light source is interfering with the PD-30AE/PD-10AE's remote sensor. Make sure that the PD-30AE/PD-10AE is not subjected to direct sunshine or inverter-type fluorescent lights. Relocate if necessary.
- If the PD-30AE/PD-10AE is installed in a cabinet with colored glass doors, the remote controller may not work reliably when the doors are closed. Open the doors, or use a cabinet without colored glass.

Company is not responsible for damages (such as CD rental fees) due to unsuccessful recordings caused by malfunctions of the unit. Before you record important data, make sure that the material will be recorded correctly.

The PD-30AE/PD-10AE contains a microcomputer for signal processing and control functions. In very rare situations, severe interference, noise from an external source, or static electricity may cause it to lockup. In the unlikely event that this should happen, unplug the power cord, wait at least 10 seconds, and then plug it again.

## Specifications

---

<b>Frequency Response:</b>	4 Hz – 20 kHz
<b>Audio Dynamic Range:</b>	100 dB
<b>THD (Total Harmonic Distortion):</b>	0.0029 %
<b>Signal to Noise Ratio:</b>	107 dB
<b>Rated RCA Output Level and Impedance:</b> (PD-30AE only)	2.0 V (rms) / 540 $\Omega$
<b>Audio Output (Digital/Optical):</b>	-22.5 dBm
<b>Audio Output/Impedance (Digital/Coaxial):</b>	0.5 V p-p / 75 $\Omega$
<b>Operation Condition</b>	
<b>Temperature/Humidity:</b>	5 °C–35 °C / 5 %–85 %

### Power Supply

North American:	AC 120 V, 60 Hz
Other:	AC 220–240 V, 50/60 Hz

**Power Consumption:** 12 W

### Stand-by Power Consumption

0.2 W

**Dimensions:**  
(W × H × D)  
435 × 103 × 298 mm  
(17 1/8 × 4 1/16 ×  
11 3/4 inches) (PD-30AE)

435 × 103 × 290 mm  
(17 1/8 × 4 1/16 ×  
11 7/16 inches) (PD-  
10AE)

**Weight:**  
5.3 kg (11.7 lbs) (PD-  
30AE)  
5.1 kg (11.2 lbs) (PD-  
10AE)

**Disc Compatibility:\*** Audio CD, CD-R,  
CD-RW, MP3 (CD-R,  
CD-RW)

\* Discs that have not been properly finalized may only be partially playable or not playable at all

### ■Audio Outputs

Digital Outputs: (PD-30AE only)	1 (OPTICAL), 1 (COAXIAL)
Analog Outputs:	1

### ■Others

Control Input/Output: (PD-30AE only)	2
---	---

Specifications and features are subject to change without notice.

# Pioneer

2-3-12 Yaesu, Chuo-ku, Tokyo 104-0028 JAPAN

## <U.S.A.>

18 PARK WAY, UPPER SADDLE RIVER, NEW JERSEY 07458, U.S.A.

Tel: 1-201-785-2600 Tel: 1-844-679-5350

## <Germany>

Hanns-Martin-Schleyer-Straße 35, 47877 Willich, Germany

Tel: +49(0)2154 913222

## <UK>

Anteros Building, Odyssey Business Park, West End Road, South Ruislip,  
Middlesex, HA4 6QQ United Kingdom

Tel: +44(0)208 836 3612

## <France>

6, Avenue de Marais F - 95816 Argenteuil Cedex FRANCE

Tel: +33(0)969 368 050

Корпорация О энд Пи

2-3-12, Яэсу, Чуо-ку, г. Токио, 104-0028, ЯПОНИЯ

Register your product on

<http://www.pioneerelectronics.com> (US)

<http://www.pioneerelectronics.ca> (Canada)

<http://www.pioneer.eu> (Europe)

© 2016 Onkyo & Pioneer Corporation. All rights reserved.

© 2016 Onkyo & Pioneer Corporation. Tous droits de reproduction et de traduction réservés.

"Pioneer" is a trademark of Pioneer Corporation, and is used under license.

Printed in Malaysia / Imprimé en Malaisie / Напечатано в Малайзии

SN 29402408

F1607-0



\* 2 9 4 0 2 4 0 8 \*