



# magnifi mini™

Home Theater Sound Bar System™

Quick Start Guide

Thank you for your Polk purchase. If you have a question or comment, please feel free to call or email us.

### Technical Assistance

In North America, call Polk Customer Service at  
**800-377-POLK(7655)** (M-F, 9 a.m.-5:30 p.m. EST)

Outside the US, call **+1-410-358-3600**

email **polkcs@polkaudio.com**

Polk Audio  
1 Viper Way, Vista, CA 92081

The complete owner's manual can be found online at  
**www.polkaudio.com**

# What's in the Box

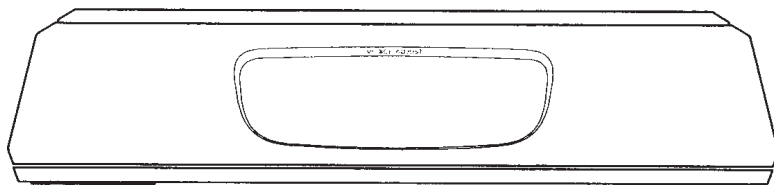

Sound bar

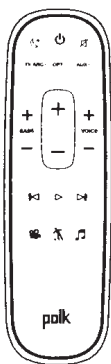

Remote control

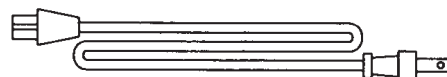

Sound bar power cord

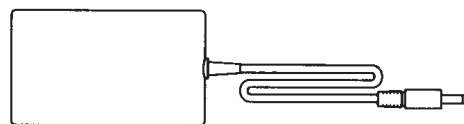

Sound bar power supply

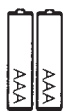

Batteries



6.5' HDMI cable



6' Optical cable

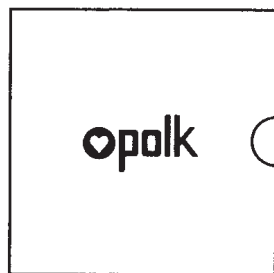

Literature

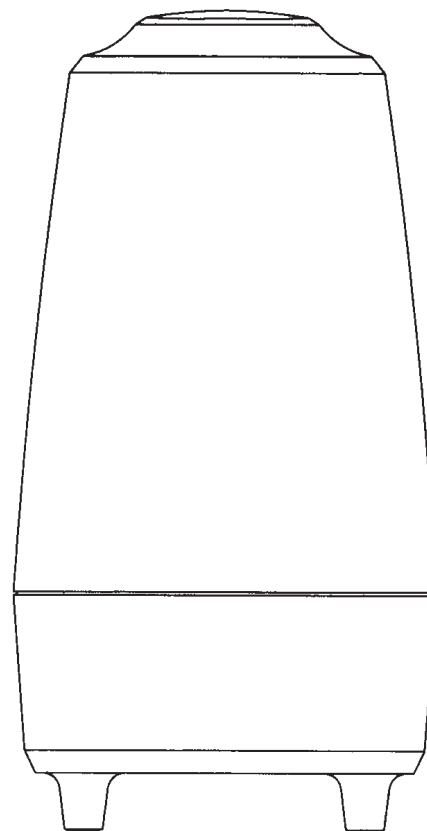

Subwoofer

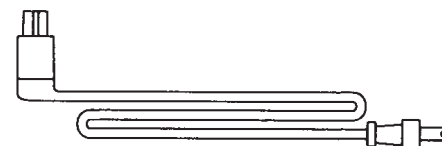

Subwoofer power cord



6' AUX cable



## Connecting Your MagniFi Mini to Your TV

1a. Is an HDMI input jack on your TV labeled “ARC”?

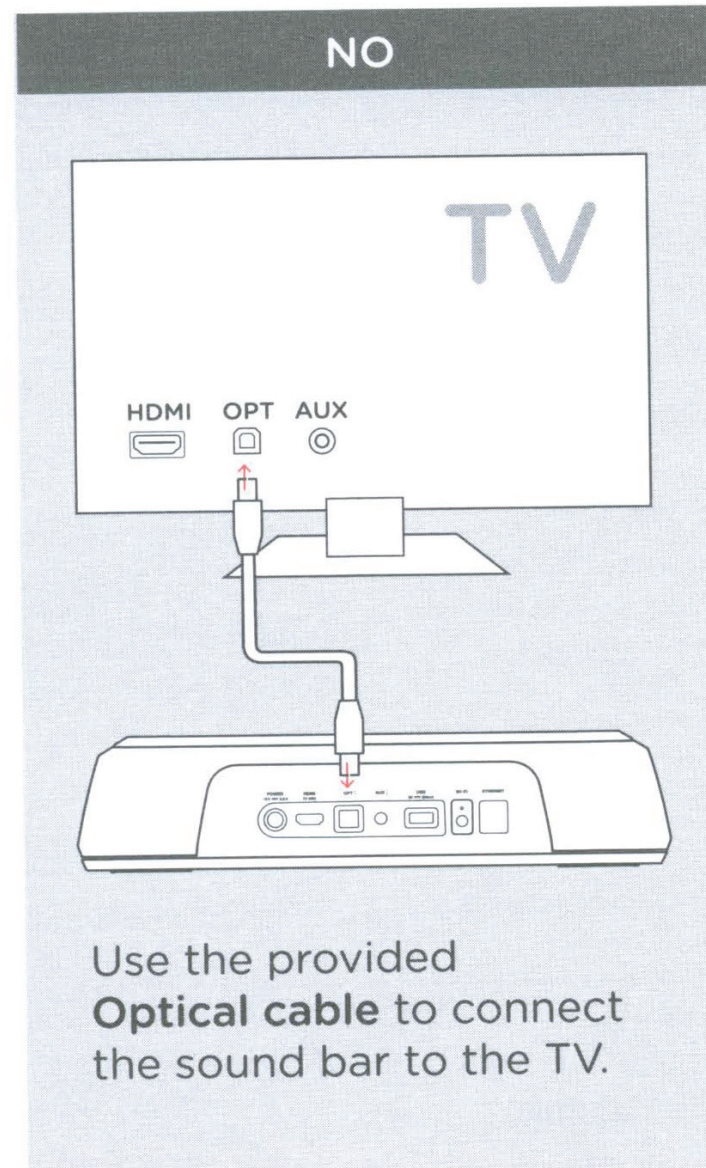
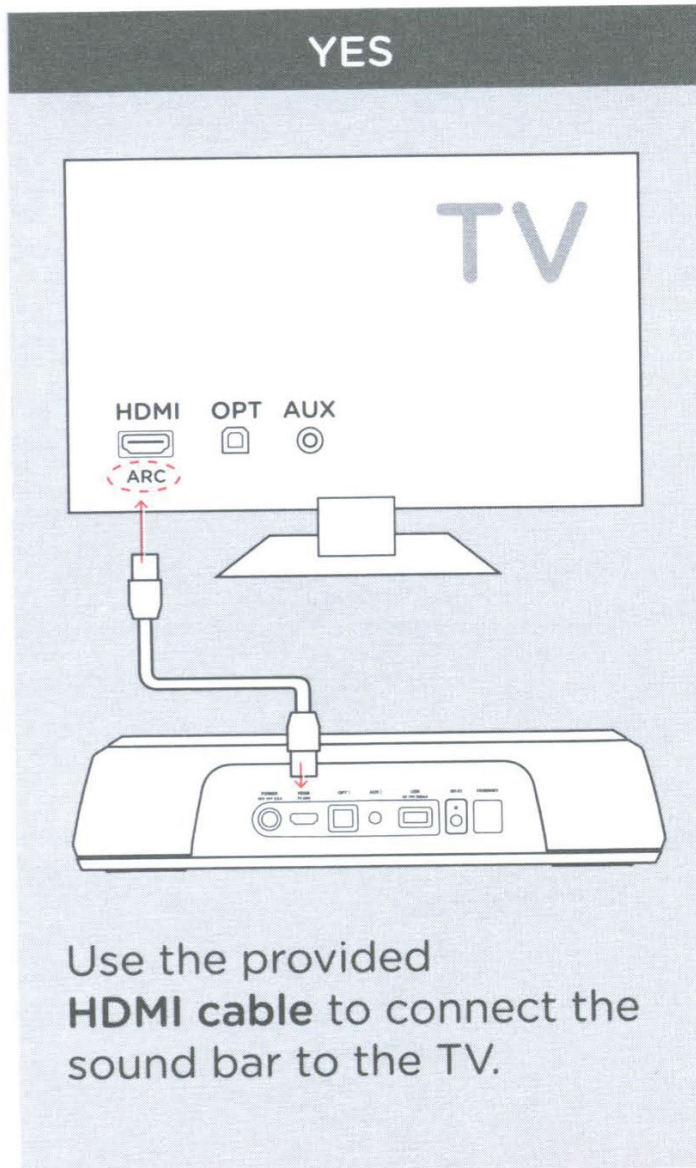

**\*You MUST have an HDMI ARC input on your TV to use HDMI.**



**1b.** Don't have HDMI or Optical input available on your TV?

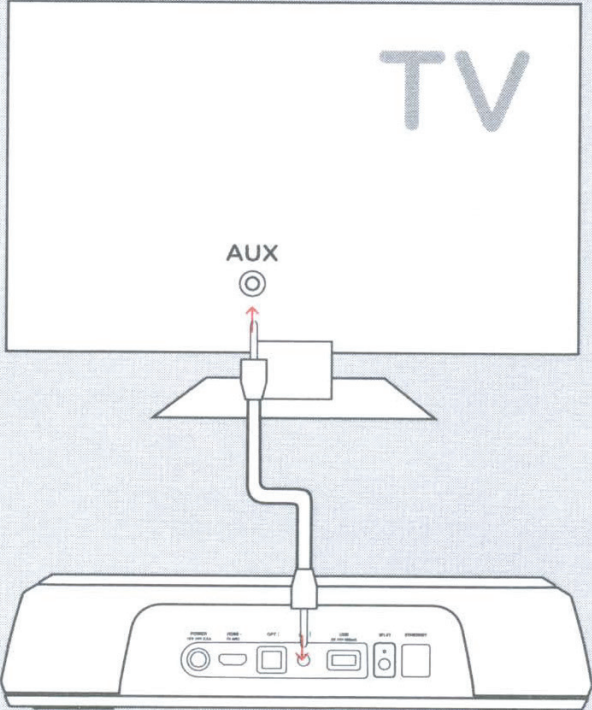

If your TV does not have an HDMI ARC or optical output, connect the sound bar to the TV with the provided **AUX cable**.

*(Only HDMI and optical inputs support Dolby 5.1 decoding)*

**2.** Remote battery installation

Insert the provided AAA batteries.

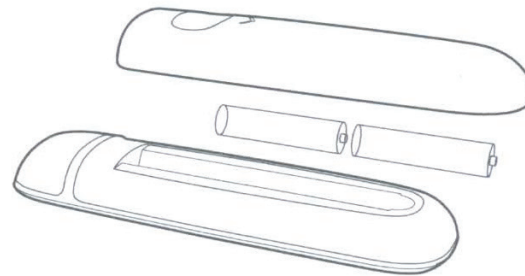

**3.** Connect the sound bar power cord to an AC outlet

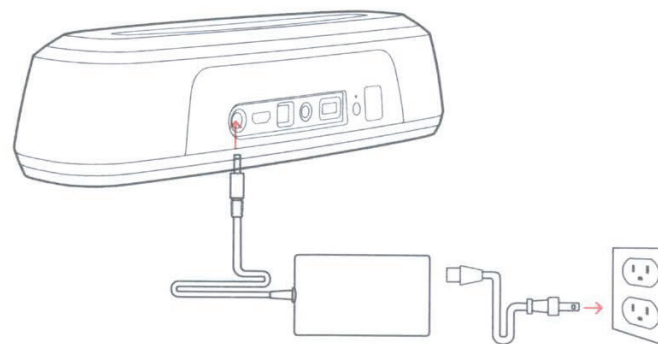

A red LED will pulse on the front of the sound bar indicating boot up.

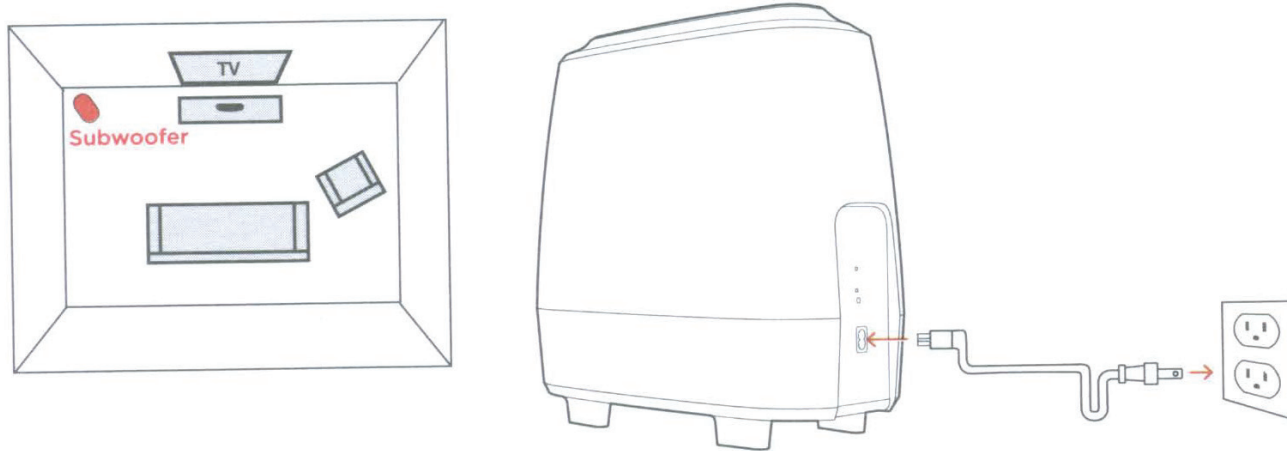

**4. Position subwoofer and connect to an AC outlet**  
(for best performance place on the same wall as the TV)



**NOTE: The MagniFi Mini sound bar and wireless subwoofer are preset at the factory to work together.** Should your wireless subwoofer stop receiving an audio signal, follow these instructions to re-establish the connection:

1. Turn on your sound bar. On the sound bar simultaneously press and hold the *Bluetooth* button  and the source button  for 3 seconds.
2. Press and hold the SYNC button on the back of the subwoofer for 3 seconds.
3. The green LED on the back of the subwoofer will start flashing at a faster rate, indicating that the sound bar and the subwoofer are connecting, the LED is solid green when connected.

**5. Turn on your sound bar**  
Press the Power button  on the sound bar or remote.  
Note: make sure TV internal speakers are off when using optical and aux inputs.



# Remote Control

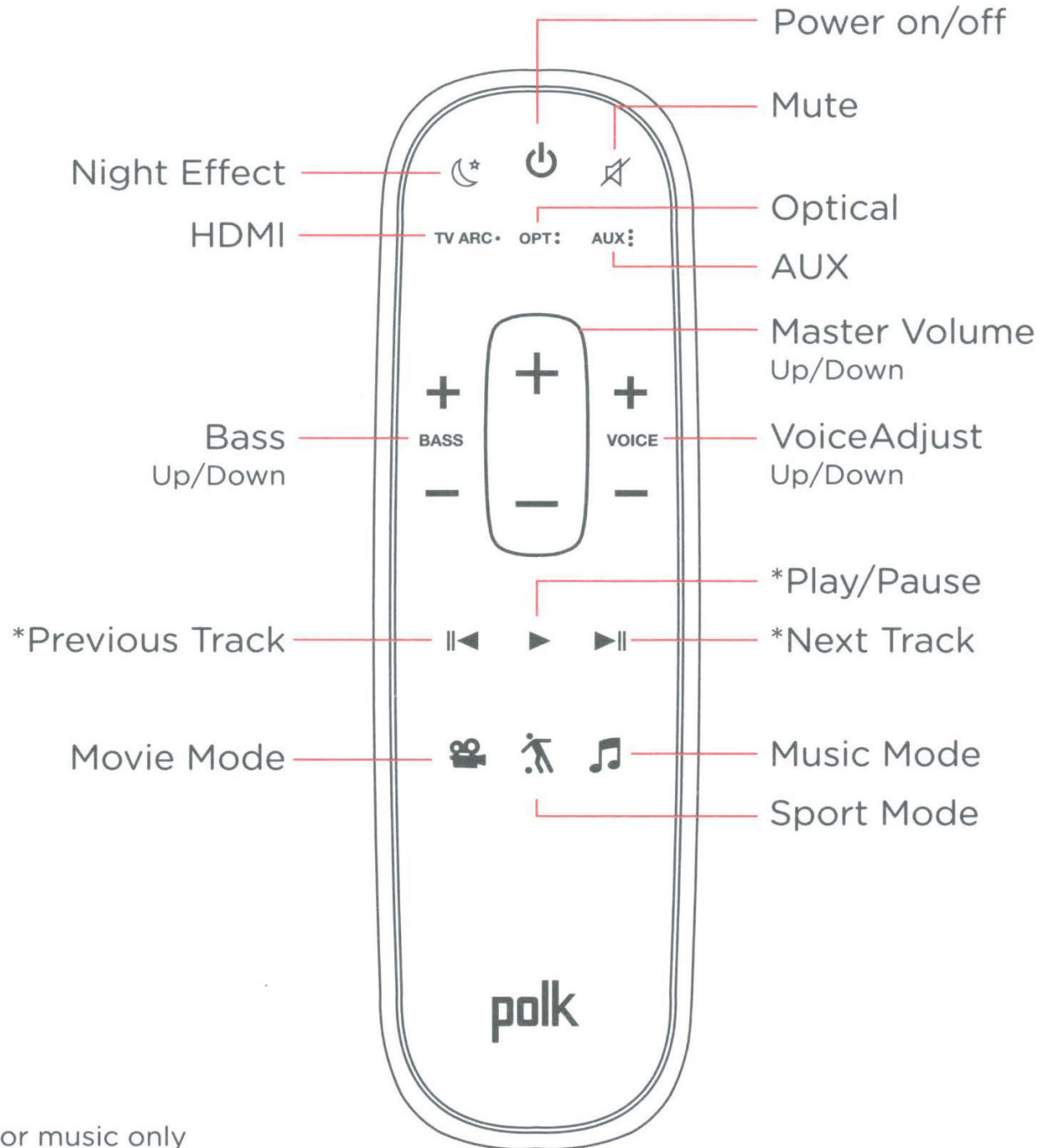

\*For music only

# Sound Bar Top Panel

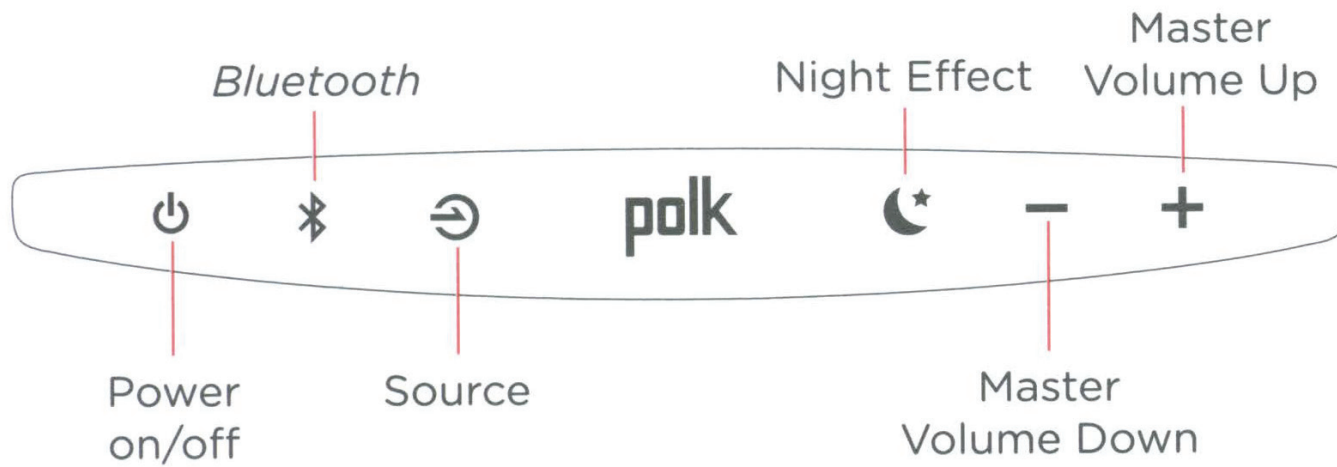



# Sound Bar Back Panel

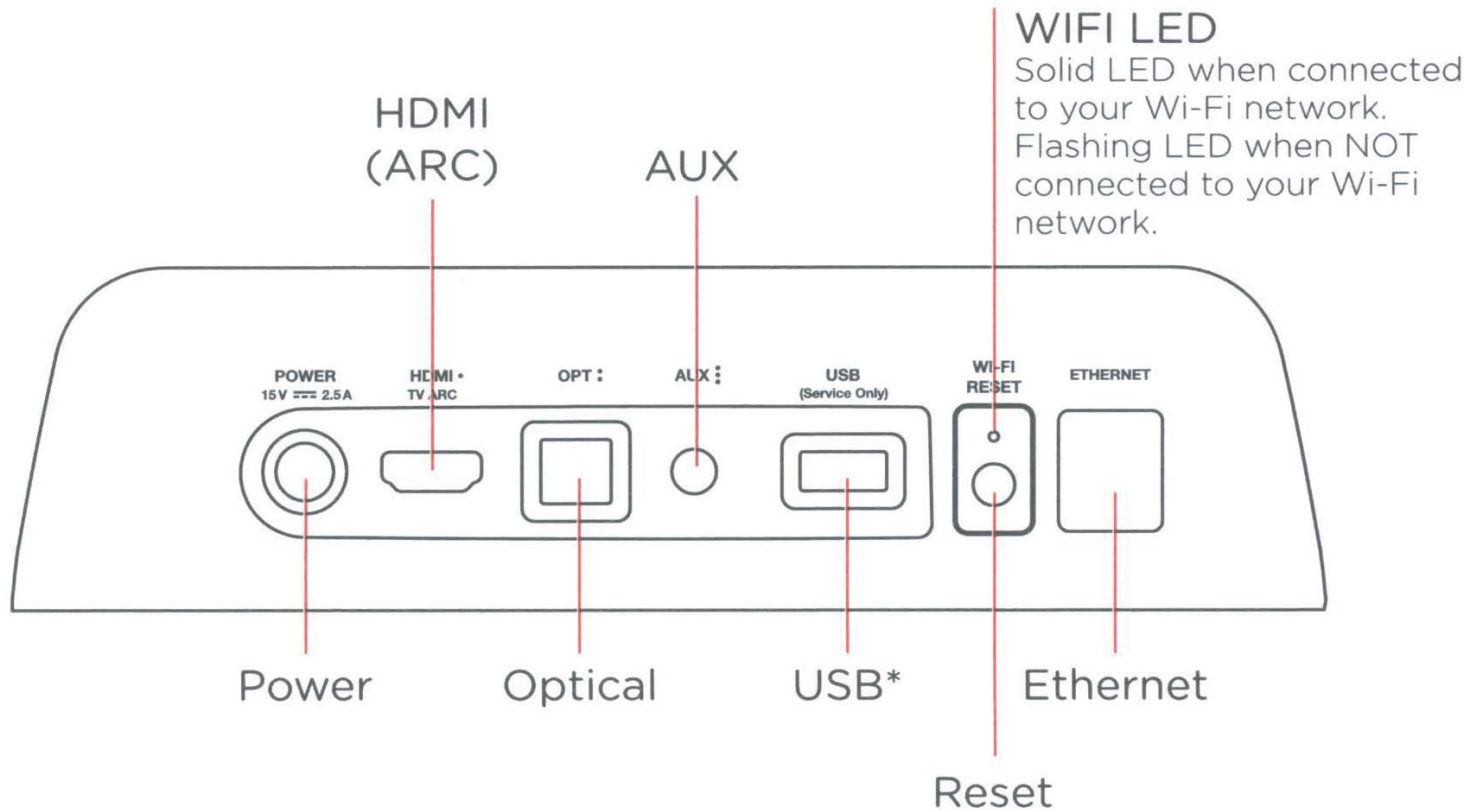

\*Factory use only

## Sound Bar LEDs

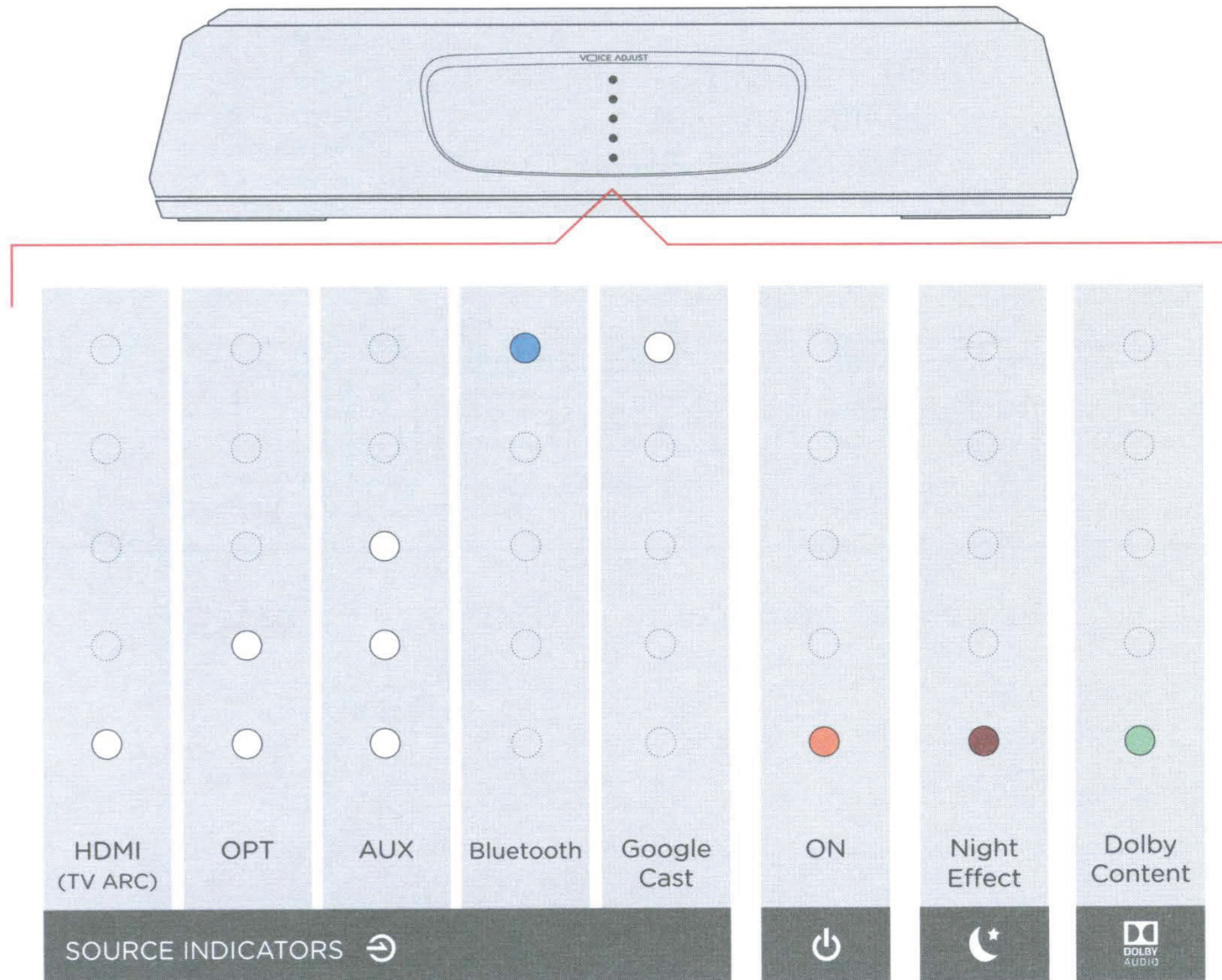

The MagniFi Mini has a vertical row of LED lights that provide status indications, like source, volume and listening modes.



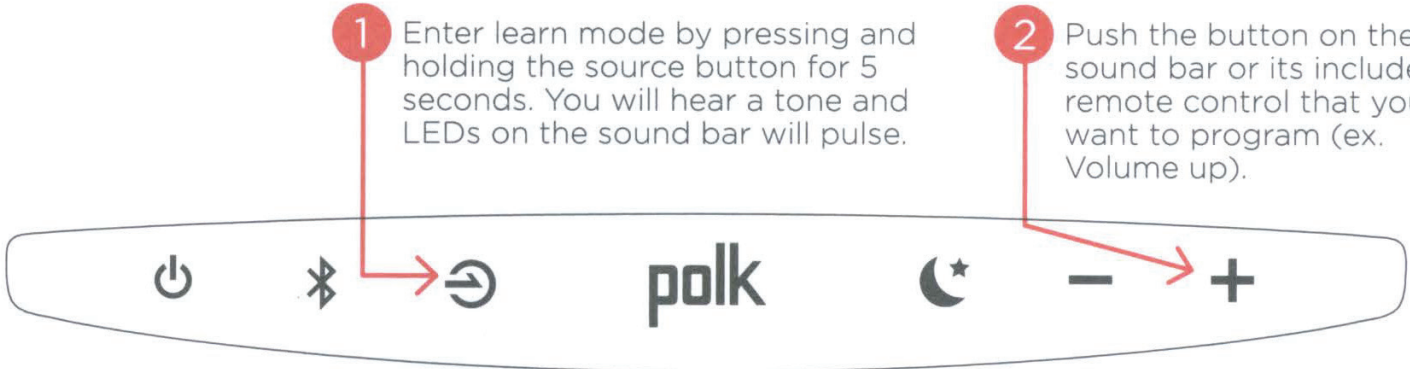

## Using Your TV or Cable/Satellite Remote (IR only) to Control the MagniFi Mini

While the MagniFi Mini works best with the included remote control, programming your sound bar to respond to another remote control is an easy process. To program each basic command to another remote, use the following instructions:

- 
- 1** Enter learn mode by pressing and holding the source button for 5 seconds. You will hear a tone and LEDs on the sound bar will pulse.
  - 2** Push the button on the sound bar or its included remote control that you want to program (ex. Volume up).
  - 3**  Press the corresponding button on your TV/Cable/Satellite remote control multiple times, a quick press every second is recommended (ex. Volume up). You will hear ascending tones when your remote control has learned the command.
  - 4** While still in learning mode, repeat steps 2 and 3 for each remote command that you want to program (ex. Volume down, Mute, Power, etc.).
  - 5** Once you're done programming the remote, press and hold the source button on the sound bar for 5 seconds to save all of the commands. You're done.

Note: To indicate a failed learn, you will hear two decending tones. The bar will exit learn mode after 1 minute of inactivity. Any learned commands will be saved. Carefully repeat steps above to re-enter Learn mode.

# Optimizing Your Listening Experience

## Bass Control

### Control Bass Volume Levels

Easily adjust bass volume for more or less impact.

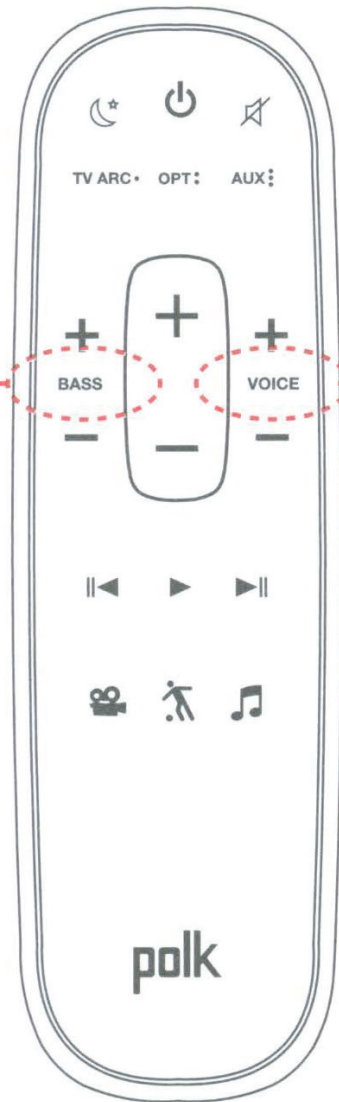
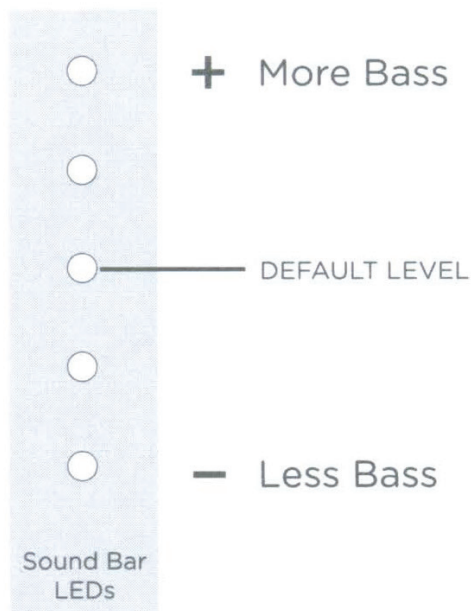

## VOICE ADJUST™

### Control Dialogue Volume Levels

Isolate and adjust the voice channel level to reproduce clear, crisp dialogue.

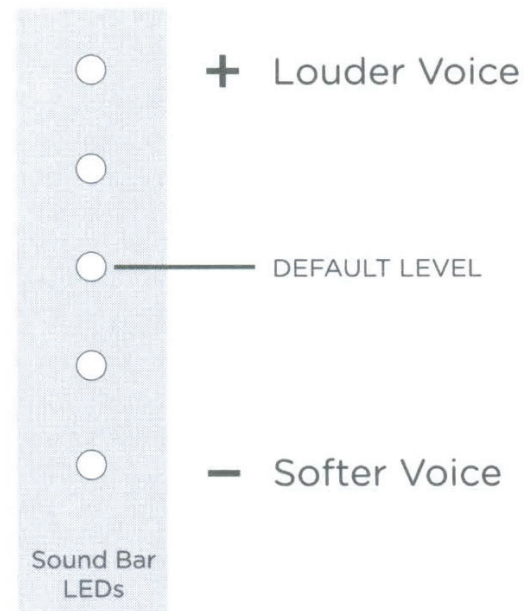



### **Movie Mode**

Enhances audio reproduction in TV and movies.



### **Music Mode**

Enhances audio whenever you're listening to music, or watching TV or movies that have music playing in them.



### **Sport Mode**

Enhances audio whenever you're watching sporting events, news and talk shows.



### **Night Effect**

Reduces bass and volume dynamics while improving voice intelligibility for low-volume listening.



## Music Services

### How to Set Up Google Cast™

1. Power on the sound bar.
2. From your phone, tablet or computer visit:  
[chromecast.com/setup](https://chromecast.com/setup)
3. Download the Cast app, click on the devices tab within the app and select MagniFi Mini. Follow in app setup instructions.



4. When you're streaming Google Cast, a white LED will appear on the sound bar.

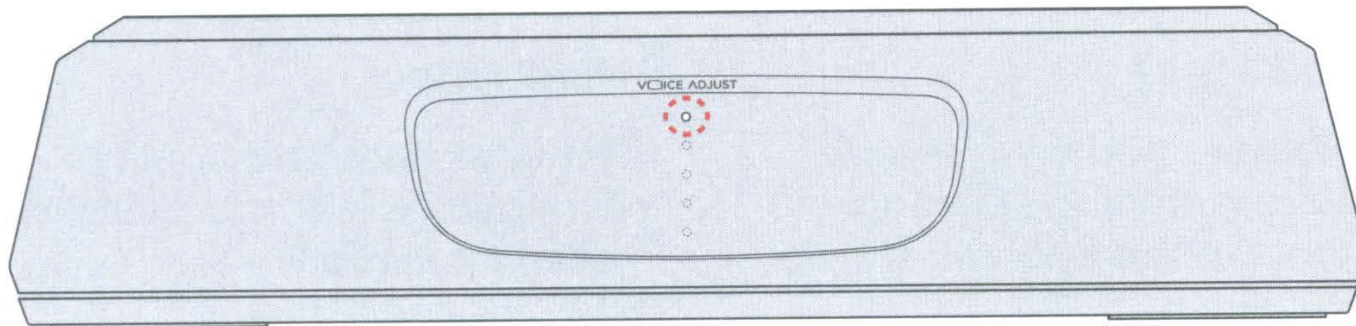

How to hear your TV again: When you are finished using Google Cast, press the source button on the sound bar or remote (TV ARC, OPT, AUX).

## How to Set Up *Bluetooth*<sup>®</sup>

1. To enable *Bluetooth*, press the *Bluetooth* button  on the sound bar. A blue LED will slowly pulse on the sound bar.

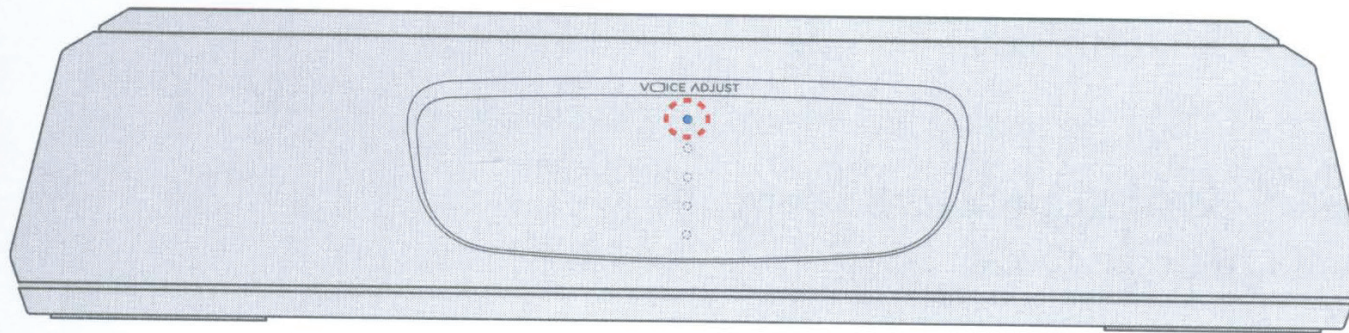

2. Go to the *Bluetooth* devices section on your phone, tablet or computer and select Polk MagniFi Mini. The LED is solid blue when *Bluetooth* is connected.

Note: To take control when another device is connected, press the *Bluetooth* button.

How to hear your TV again: When you are finished using *Bluetooth*, press the source button on the sound bar or remote (TV ARC, OPT, AUX).

**polk**

1 Viper Way  
Vista, CA 92081  
800-3777655  
[www.polkaudio.com](http://www.polkaudio.com)



HBP3656B



## Using Your TV or Cable/Satellite Remote (IR only) to Control the MagniFi Mini

The MagniFi Mini works best with the included remote, however you can also teach it to respond to your favorite TV or cable IR remote by following these steps:

**IMPORTANT:** Hold both remotes about 12" (30cm) directly in front of the MagniFi Mini when pressing their respective buttons, make sure you wait at least 1 second between button presses, make sure your remotes have fresh batteries

1. Enter learn mode by pressing and holding the  Source button on the sound bar until you hear a tone and the lights on the front of the sound bar pulse up and down.
2. Press and release the button on the MagniFi Mini remote that you want to learn (ex: Volume Up).
3. Press and Release the corresponding button on YOUR remote repeatedly until you hear a two note ascending tone.  
NOTE: Make sure you wait at least 1 second between button presses!
4. Repeat steps 2 and 3 to learn Volume Down, Mute, and Power buttons from your remote.
5. Exit learn mode by pressing and holding the  Source button on the sound bar again until you hear a tone and the lights on the front of the sound bar stop pulsing.
6. Verify that your remote can control the buttons you programmed (ex: Volume up) on the MagniFi Mini.

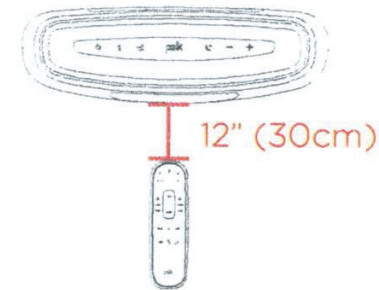

**NOTE:**

- You will hear a different (descending) tone if the command failed to learn. Please try again.
- MagniFi Mini will exit Learn mode after 1 minute of inactivity, saving any learned codes





Register your new Polk product online now  
for a chance to win \$500 of Polk product!  
[www.polkaudio.com/registration/](http://www.polkaudio.com/registration/)

#### Benefits

- Permanent record of your purchase, in case you misplace your original receipt.
- Enters you in our monthly FREE drawing for \$500-worth of Polk speakers.
- Allows you to enroll in Club Polk Benefits:
  - Informative Polk website forums
  - Special discounts in the Polk web store
  - Advance notice of Polk promos
  - Discounts on authorized Polk parts
  - Stay up-to-date on all the latest news and announcements about your product

No Internet access? Call Polk Customer Service at 800-377-POLK(7655) (US & Canada only).  
Outside the US & Canada, call 410-358-3600. We'll walk you through the simple  
registration process!

We take your privacy seriously. Polk does not share or sell information to any other parties, unless directed by court order.  
Registering your product has no effect on your warranty. Warranties apply as stated in your important product information guide.  
Please be sure to keep your original purchase receipt.

Questions? Concerns? Contact Polk Customer Service from 9am - 5:30pm, M-F, EST(USA)  
800-377-POLK(7655) US & Canada only | 410-358-3600 outside US & Canada | [polkcs@polkaudio.com](mailto:polkcs@polkaudio.com)

HBP3321





magnifi mini™

Important Product Information



# Safety Precautions

## FCC Statement

1. This device complies with Part 15 of the FCC Rules. Operation is subject to the following two conditions:
  - (1) This device may not cause harmful interference, and
  - (2) This device must accept any interference received, including interference that may cause undesired operation.
2. Any Changes or modifications not expressly approved by the party responsible for compliance could void the user's authority to operate the equipment.

**NOTE:** This equipment has been tested and found to comply with the limits for a Class B digital device, pursuant to Part 15 of the FCC Rules. These limits are designed to provide reasonable protection against harmful interference in a residential installation. This equipment generates uses and can radiate radio frequency energy and, if not installed and used in accordance with the instructions, may cause harmful interference to radio communications. However, there is no guarantee that interference will not occur in a particular installation. If this equipment does cause harmful interference to radio or television reception, which can be determined by turning the equipment off and on, the user is encouraged to try to correct the interference by one or more of the following measures:

- Reorient or relocate the receiving antenna.
- Increase the separation between the equipment and receiver.
- Connect the equipment into an outlet on a circuit different from that to which the receiver is connected.
- Consult the dealer or an experienced radio/TV technician for help.

## FCC RF Radiation Exposure Statement

1. This transmitter must not be colocated or operating in conjunction with any other antenna or transmitter.
2. This equipment complies with FCC radiation exposure limits set forth for an uncontrolled environment. This equipment should be installed and operated with minimum distance 20cm between the radiator & your body.

## 3. FCC RF Warning

This equipment must be installed and operated in accordance with provided instructions and the antenna(s) used for this transmitter must be installed to provide a separation distance of at least 20 cm from all persons and must not be co-located or operating in conjunction with any other antenna or transmitter. End-users and installers must be provide with antenna installation instructions and transmitter operating conditions for satisfying RF exposure compliance.

## IC RF Radiation Exposure Stament

This device complies with the Canada portable RF exposure limit set forth for an uncontrolled environment and are safe for intended operation as described in this manual. The further RF exposure reduction can be achieved if the product can be kept as far as possible from the user body or set the device to lower output power if such function is available.

## Canada, Industry Canada (IC) Notices

This Class B digital apparatus complies with Canadian ICES-003. To reduce potential radio interference to other users, the antenna type and its gain should be so chosen that the equivalent isotropically radiated power (e.i.r.p.) is not more than that permitted for successful communication.

This device complies with Industry Canada licence-exempt RSS standard(s).

- (1) this device may not cause interference, and
- (2) this device must accept any interference, including interference that may cause undesired operation of the device.

## Radio Frequency (RF) Exposure Information

The radiated output power of the Wireless Device is below the Industry Canada (IC) radio frequency exposure limits. The Wireless Device should be used in such a manner such that the potential for human contact during normal operation is minimized.

This device has also been evaluated and shown compliant with the IC RF Exposure limits under mobile exposure conditions. (antennas are greater than 20cm from a person's body).

## 2.412~2.472GHz Band

This device operates in the 2.412~2.472GHz range.

## 5.15~5.25GHz Band

Operations in the 5.15-5.25GHz band are restricted to indoor use only.

### Slave Equipment:

This device is slave equipment, the device is not radar detection and not ad-hoc operation in the DFS band.

### Important Safety Instructions

1. Read these instructions.
2. Keep these instructions.
3. Heed all warnings.
4. Follow all instructions.
5. Do not use this apparatus near water.
6. Clean only with dry cloth.
7. Do not block any ventilation openings. Install in accordance with the manufacturer's instructions.
8. Do not install near any heat sources such as radiators, heat registers, stoves, or other apparatus (including amplifiers) that produce heat.
9. Do not defeat the safety purpose of the polarized or grounding-type plug. A polarized plug has two blades with one wider than the other. A grounding type plug has two blades and a third grounding prong. The wide blade or the third prong are provided for your safety. If the provided plug does not fit into your outlet, consult an electrician for replacement of the obsolete outlet.
10. Protect the power cord from being walked on or pinched particularly at plugs, convenience receptacles, and the point where they exit from the apparatus.
11. Only use attachments/accessories specified by the manufacturer.



Authorized  
Representative:  
Sound United  
Wormser Strasse 6  
D-58091 Hagen

12. Use only with the cart, stand, tripod, bracket, or table specified by the manufacturer, or sold with the apparatus. When a cart is used, use caution when moving the cart/apparatus combination to avoid injury from tip-over.
13. Unplug this apparatus during lightning storms or when unused for long periods of time.
14. Refer all servicing to qualified service personnel. Servicing is required when the apparatus has been damaged in any way, such as power-supply cord or plug is damaged, liquid has been spilled or objects have fallen into the apparatus, the apparatus has been exposed to rain or moisture, does not operate normally, or has been dropped.
15. The equipment could be used at maximum 45 degree C ambient temperature
16. Do not open the equipment to reduce the risk of electrical shock. For safety reasons it is only allow to the opened by qualified service personnel.
17. **WARNING:** To reduce the risk of fire or electric shock, do not expose this apparatus to rain or moisture. And the apparatus shall not be exposed to dripping or splashing and that no objects filled with liquids, such as vases, shall be placed on the apparatus.
18. The AC inlet is used as the disconnect device and shall remain readily operable.
19. The product shall be used on open bench.
20. No naked flame sources, such as lighted candles, should be placed on the apparatus.



	The lightning flash with arrowhead symbol, within an equilateral triangle, is intended to alert the user to the presence of uninsulated dangerous voltage within the product's enclosure that may be of sufficient magnitude to constitute a risk of electric shock to persons.
	The exclamation point within an equilateral triangle is intended to alert the user to the presence of important operating and maintenance (servicing) instructions in the literature accompanying the appliance.

21. CAUTION: Danger of explosion if battery is incorrectly replaced. Replace only with the same or equivalent type.
22. The battery (battery or batteries or battery pack) shall not be exposed to excessive heat such as sunshine, fire or the like.
23. WARNING: If battery compartment does not close securely, stop using the product and keep it away from children and pets.
24. WARNING: Do not recharge non-rechargeable batteries.
25. WARNING: Avoid exposure to extreme heat or cold.

**WARNING:** Please refer to the information on exterior bottom enclosure for electrical and Safety information before installing or operating the apparatus.

#### **EU Compliance Information**

Eligible to bear the CE mark; Conforms to European Union Low Voltage Directive 2014/35/EC; European Union EMC Directive 2014/30/EU; European Union Restriction of Hazardous Substances Recast (RoHS) Directive 2011/65/EU; European Union

WEEE Directive 2012/19/EU; European Union Eco-Design Directive 2009/125/EC; European Union Registration, Evaluation,

Authorization and Restriction of Chemicals (REACH) Directive 2006/121/EC; European Union Radio and Telecommunications Terminal Equipment (R&TTE) Directive 1999/5/EC.



Hereby, Polk, declares that **MagniFi Mini Soundbar & Sub** is in compliance with the essential requirements and other relevant provisions of Directive 1999/5/EC.

- EN 300 328 V1.9.1 (2015-02) :  
Electromagnetic compatibility and Radio spectrum Matters (ERM); Wideband transmission systems; Data transmission equipment operating in the 2,4 GHz ISM band and using wide band modulation techniques;

Harmonized EN covering the essential requirements of article 3.2 of the R&TTE Directive.

- EN 301 489-1 V1.9.2 (2011-09)  
Electromagnetic compatibility and Radio Spectrum

Matters (ERM); ElectroMagnetic Compatibility (EMC) standard for radio equipment and services; Part 1: Common technical requirements

- EN 301 489-17 V2.2.1 (2012-09)  
Electromagnetic compatibility and Radio spectrum Matters (ERM); ElectroMagnetic Compatibility (EMC) standard for radio equipment and services; Part 17: Specific conditions for 2.4 GHz wideband transmission systems and 5 GHz high performance RLAN equipment

- EN 62479:2010  
Assessment of the compliance of low power electronic and electrical equipment with the basic restrictions related to human exposure to electromagnetic fields (10 MHz to 300 GHz)

#### **1-Year Limited Warranty**

Polk Audio, LLC ("Polk") warrants to the original retail purchaser that Polk Audio branded wireless speakers, will be free from defects in materials and workmanship for a period of (1) one year, under normal use and conditions. Should this product prove to be defective in material or workmanship, Polk will, at its option, (a) repair the product, or (b) replace the product. If the product model is no longer available and cannot be repaired effectively, or replaced with an identical model, Polk may, at its sole and absolute option, replace the unit with a current model of equal or greater value.

To obtain warranty service, please visit the Polk Audio website at [www.polkaudio.com](http://www.polkaudio.com). You may also contact Polk Audio Customer Service at 1-800-377-7655 for instructions on where to send the product. You will be required to provide an original receipt or bill of sale, identifying you as the original purchaser and identifying the purchase made through an authorized Polk retailer. You will need to ship the product, prepaid and insured, together with the proof of purchase to Polk Audio, 1 Viper Way, Vista, CA 92081. Risk of loss or damage in transit shall be borne by the purchaser. Freight collect shipments will be refused.

This warranty is non-transferable and does not apply to any product that has been modified or used in a manner contrary to its intended purpose. This limited warranty is void if the product has an altered or missing serial number, or if the product was purchased from someone other than an authorized dealer. This limited warranty is void if the product has been damaged by accident or unreasonable use, neglect, improper service or other causes not arising



out of defects in material or construction. Product(s) which are found to be damaged by abuse resulting in thermally damaged voice coils are not covered by this warranty but may be replaced at the sole and absolute discretion of Polk. This warranty terminates if you sell or otherwise transfer the product to another party. This limited warranty does not cover cosmetic damage, paint damage, damage to other components, parts or premises, or any consequential damages which may result for any reason.

Polk does not warrant that the product will operate without interruption or that the product will operate error-free. Certain external conditions which are out of Polk's control may affect the overall performance of the product, including, but not limited to, wireless network configuration,

performance of the wireless network, distances between product and the wireless network connection and/or content sources, third party devices, radio and/or environmental interference with the product.

Polk may offer access to third party content or third party content providers via the Product. Polk reserves the right to alter, change, discontinue or modify access to any third party content or any third party content provider at any time, for any reason. Polk disclaims all warranties and representations offered by any third party content or third party content provider.

Polk shall have no obligation to provide any updates or upgrades to the product, but in the event that it does, such updates and upgrades shall be deemed the "product", and shall be subject to the terms and conditions stated herein.

THIS WARRANTY GIVES YOU SPECIFIC LEGAL RIGHTS AND YOU MAY HAVE OTHER RIGHTS THAT VARY FROM STATE TO STATE. ALL WARRANTIES, INCLUDING BUT NOT LIMITED TO EXPRESS WARRANTY, IMPLIED WARRANTIES OF MERCHANTABILITY AND FITNESS FOR A PARTICULAR PURPOSE, NON-INFRINGEMENT AND THE IMPLIED CONDITION OF SATISFACTORY QUALITY ARE EXPRESSLY EXCLUDED AND DISCLAIMED TO THE MAXIMUM EXTENT ALLOWED BY LAW, AND POLK NEITHER ASSUMES NOR AUTHORIZES ANY PERSON TO ASSUME FOR IT ANY LIABILITY IN CONNECTION WITH THE SALE OF THE PRODUCT. POLK HAS ABSOLUTELY

NO LIABILITY FOR ANY ACTS OF THIRD PARTIES. SOME STATES DO NOT ALLOW THE EXCLUSION OF CERTAIN IMPLIED WARRANTIES, OR CONDITIONS ON AN IMPLIED WARRANTY, SO THE ABOVE LIMITATION MAY NOT APPLY TO YOU. POLK DOES NOT ACCEPT LIABILITY FOR SPECIAL, INDIRECT, INCIDENTAL, PUNITIVE OR CONSEQUENTIAL DAMAGES, LOST PROFITS, LOST SAVINGS OR DAMAGES RESULTING FROM IMPROPER USE, OR THE INABILITY TO USE THE PRODUCT. THE MAXIMUM LIABILITY FOR WHICH POLK MAY BE RESPONSIBLE SHALL NOT EXCEED THE PURCHASE PRICE OF THE PRODUCT. SOME STATES DO NOT ALLOW THE EXCLUSION OR LIMITATION OF INCIDENTAL OR CONSEQUENTIAL DAMAGES, SO THE ABOVE LIMITATION OR EXCLUSIONS MAY NOT APPLY TO YOU.

**WARNING:** This product contains a chemical known to the State of California to cause cancer.



1 Viper Way  
Vista, CA 92081  
800 638 7276  
[www.polkaudio.com](http://www.polkaudio.com)

HBP3657B