



Digital Sound Projector

YSP-5600

Owner's Manual

**for North America, Central and South America,
Australia, Asia and Taiwan models**

Read the supplied booklet "Quick Reference Guide" before using the unit.

English

CONTENTS

FEATURES 4

What you can do with this unit	4
Supplied accessories	6
Preparing remote control	7
Controls and functions	8

PREPARATIONS 11

General setup procedure	11
1 Installation	12
2 Connecting a TV	22
3 Connecting playback devices	23
4 Other connections	25
Connecting a subwoofer	25
Wired network connections	25
5 Connecting the power cable	26
6 Initial settings	27
Displaying the menu screen on the TV	27
Selecting the language for menu display	28
Auto setup for appropriate surround effects (IntelliBeam)	29
Operating the unit by TV's remote control (HDMI control)	34

PLAYBACK 36

Basic operation for playback	36
Enjoying sound based on your preference	37
Playback with 3D surround sound	37
Playback with surround sound	38
Enjoying three-dimensional surround sound (CINEMA DSP 3D/CINEMA DSP)	38
2-channel playback (stereo playback mode)	40
Delivering sound to a specified location (target playback mode)	40
Playing back digitally compressed formats (such as MP3, etc.) with enriched sound (Compressed Music Enhancer)	41
Clear playback of human voices (CLEAR VOICE)	41
Adjusting the position from which dialog is heard (Dialog Lift)	41
Adjusting volume for each channel	42
Using useful features	43
Saving energy with the Eco function	43
Switching information displayed in the front panel display	43
Saving this unit's settings to system memory	44
Wireless playback of audio via <i>Bluetooth</i> connection	45
Listening to music from a <i>Bluetooth</i> device (Receiving)	46
Listening to audio through <i>Bluetooth</i> speakers or headphones (transmitting)	48

NETWORKS 49

Network functions	49
Connecting to a network	50
Wired network connections	51
Wireless network	51
Connecting a mobile device to the unit directly (Wireless Direct)	58
Playing back music stored on media servers (PCs/NAS)	60
Media sharing setup	60
Playing music files	60
Listening to Internet radio	61
Playback of Internet radio	61
Registering favorite Internet radio stations	61
Playing back music with AirPlay	63
Playback of iTunes/iPod music contents	63
Playing back music stored on mobile devices	65
Using a mobile device to play songs	65

SETTINGS 66

Setup menu	66
Setting the setup menu	66
Setup menu list	67
Beam	69
Sound	74
HDMI	76
Display	77
Information	78
Network	79
Bluetooth	82
Settings each input source (Option menu)	83
Setting the option menu	83
Option menu list	84
Advanced setup	85
Setting the advanced setup	85
Advanced setup list	86
Updating the unit's firmware	87
Using "Network Update" in the setup menu to update firmware	87
Updating firmware with connection of a USB flash drive	88

APPENDIX 90

Troubleshooting	90
General	90
Bluetooth	94
Remote control	95
Network	96
Messages in the front panel display	98
When surround effect is not enough	99
Installing and adjusting the sound reflection board YRB-100	99
Basic Knowledge of Surround Sound	101
What is a Digital Sound Projector?	101
What is Object Based Audio?	102
Yamaha's Audio Technologies	102
Glossary	103
Network information	104
Specifications	105
Index	108

FEATURES

What you can do with this unit

Sound beams are reflected off walls and a ceiling using unique real surround sound formats and techniques, allowing listeners to enjoy their preferred acoustic environment.

- Automatically and quickly adjusts surround sound effects for the listening room setup (IntelliBeam) [p. 29](#)
- Emphasize the sense of immersion and reality of the sound field with overhead sounds fed via height channels (3D Surround Sound) [p. 37](#)
- Reproducing stereo or multichannel sounds with the sound fields like actual movie theaters and concert halls (CINEMA DSP 3D/CINEMA DSP) [p. 38](#)
- Enjoying compressed music with enhanced sound (Compressed Music Enhancer) [p. 41](#)
- Delivering sound to a specified location (Target playback mode) [p. 40](#)

Sequential operation of a TV, this unit, and BD/DVD player (HDMI Control) [p. 34](#)

Subwoofer (optional or available from third-party manufactures)

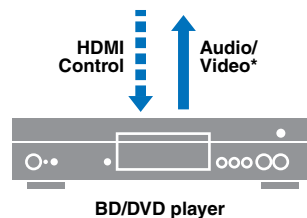
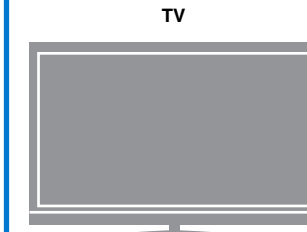
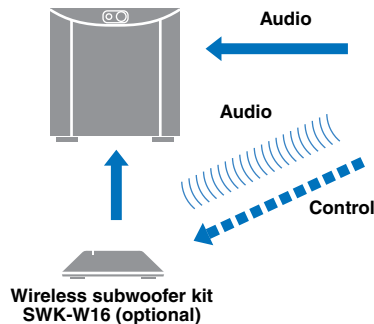

Dedicated apps for mobile devices [p. 5](#)



Wide variety of supported content

- Media server (PC/NAS) [p. 60](#)
- Internet radio [p. 61](#)
- AirPlay [p. 63](#)
- Music stored on mobile devices [p. 65](#)

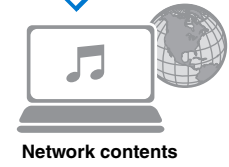

MusicCast devices

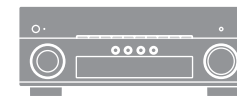

Share music via your home network [p. 5](#)

Plays back audio content from **Bluetooth®** devices [p. 46](#)



Listen to audio input to the unit with **Bluetooth** headphones or speakers [p. 48](#)



* Supports 4K video and HDCP version 2.2

Achieve true 3D surround sound including height channel audio with the unit alone

Until now, digital sound projectors have reproduced a two-dimensional sound field with five distinct sound beams: left front, right front, center, left surround, and right surround. This unit reproduces a three-dimensional sound field offering a greater sense of immersion and depth by directing additional two sound beams (left height and right height) upward. It also enables playback in the DTS:X or Dolby Atmos format, which uses height channel audio signals as input sources. It further incorporates CINEMA DSP 3D, which produces a more effective sound field.

The sound image of the system

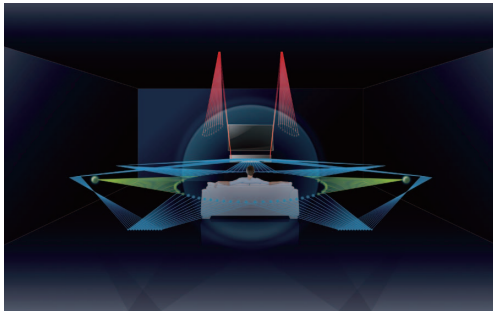

Dialog Lift function

When playing movies, this feature can be adjusted so that audio such as narratives and dialog is output from the center speakers, as in a movie theater where speakers are installed behind the screen, allowing for a sense of integration of conversation with the movements of the actors (p. 41).

Unrestricted playback of music over a network using MusicCast CONTROLLER

The free dedicated app for mobile devices, MusicCast CONTROLLER, allows you to listen to music stored on mobile devices such as smartphones, or on servers, or to listen to Internet radio stations and many kinds of major streaming services.

This app also allows you to distribute content to other MusicCast-enabled devices for synchronized playback.

See the “MusicCast Setup Guide” for details.

Search for “MusicCast CONTROLLER” on the App Store or Google Play.

Bluetooth functions

You can receive and play audio from a *Bluetooth* device, such as a mobile device over a wireless connection. You can also transmit audio input to the unit to a *Bluetooth* headphones.

Using HOME THEATER CONTROLLER (WLAN) to easily operate the unit

The free dedicated app for mobile devices, HOME THEATER CONTROLLER (WLAN), allows you to easily operate the unit, performing such tasks as configuring sound beams on a visual screen, selecting an input source, and adjusting the volume on a mobile device.

Search for “HOME THEATER CONTROLLER (WLAN)” on the App Store or Google Play.

Wireless subwoofer connection using the optional wireless subwoofer kit



The unit and the subwoofer can be connected via a wired connection. In addition, a wireless connection can be established using the optional wireless subwoofer kit (SWK-W16) (p. 25).



- In this manual, iOS and Android mobile devices are collectively referred to as “mobile devices”. The specific type of mobile device is noted in explanations as needed.

About this manual

- In this manual, operations that can be performed using either the front panel keys or the remote control are explained using the remote control.

-  indicates supplementary explanations for better use.
-  indicates precautions for use of the unit and its feature limitations.

Supplied accessories

Before connecting, make sure you have received all of the following items.

YSP-5600

The unit



- The supplied optical cable may not be needed depending upon connections.

Supplied accessories

Remote control



Batteries
(AAA, R03, UM-4) (x2)

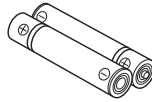

Optical cable
(1.5 m (4.9 ft))¹



Power cable (2 m (6.6 ft))²



IntelliBeam microphone
(6 m (19.7 ft))

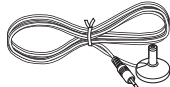

Cardboard microphone stand

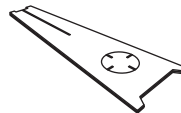

Stands (x2)



Screws (For the stands; x2)



- Owner's Manual CD-ROM
- Quick Reference Guide
- MusicCast Setup Guide

¹ China model only: Instead of the optical cable, a digital coaxial audio cable is supplied.

² The shape of the power cable plug varies depending on where the unit was purchased.

Preparing remote control

Before installing batteries or using the remote control, be sure to read battery and remote control precautions in "Quick Reference Guide" (separate booklet).

Installing the batteries

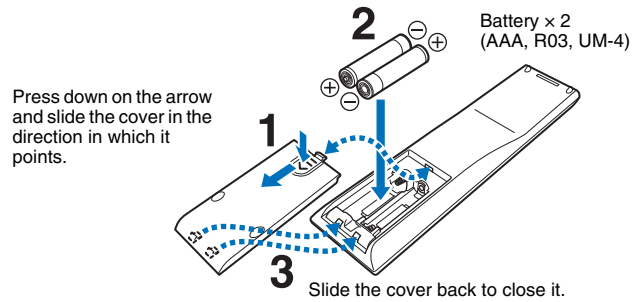

Operation range

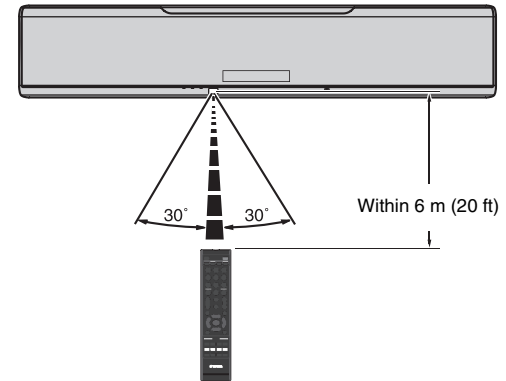

Controls and functions

The unit (front, top)

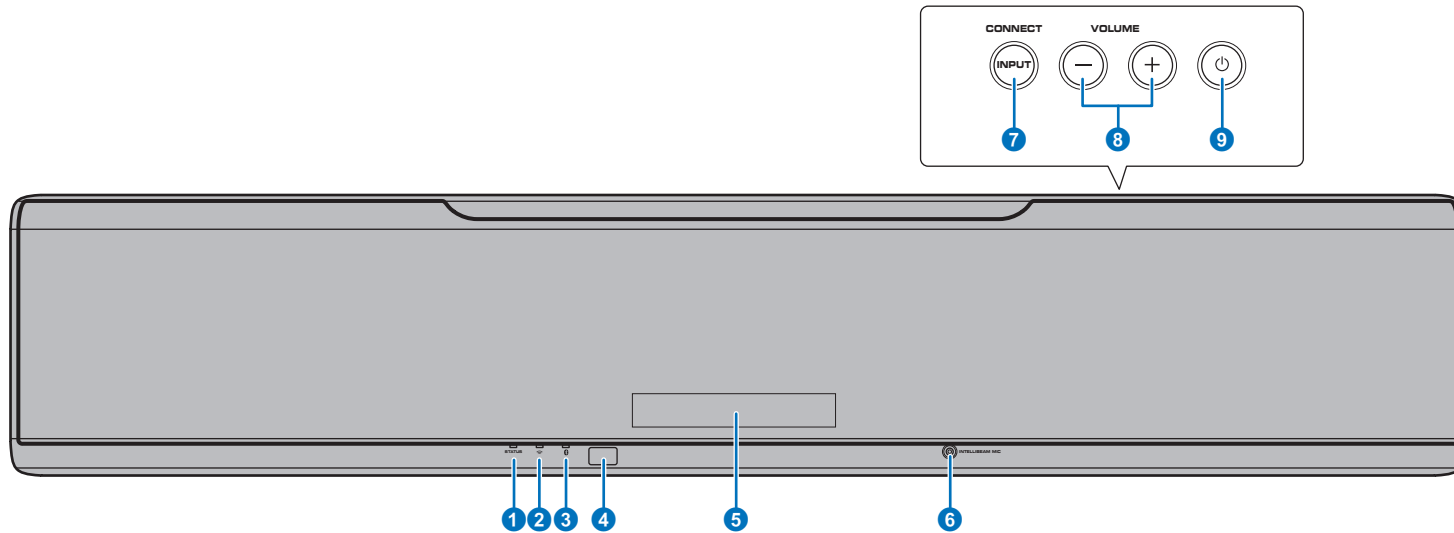

1 STATUS indicator

Lights to show the system condition.
Glowes green: Power on
Glowes red: Power off (when the HDMI control or network standby is activated)
Turns off: Power off

2 (Wi-Fi) indicator

Shows the status of wireless network connection (p. 51).

3 (Bluetooth) indicator

Shows the status of *Bluetooth* connection (p. 45, 48).

4 Remote control sensor

Receives infrared signals from the remote control (p. 10).

5 Front panel display

Displays the unit's settings, such as the name of an audio input source or surround mode (p. 43). The setting values are also displayed.

6 INTELLIBEAM MIC jack

For connecting the supplied IntelliBeam microphone (p. 30).

7 INPUT/CONNECT key

INPUT key

Select an audio input source.

CONNECT key

Use to control the unit using the dedicated MusicCast CONTROLLER app for mobile devices. See the MusicCast Setup Guide for details.

8 VOLUME (+/-) keys

Adjust the volume of the unit (p. 36).

9 key

Turn on/off the unit.



- When the unit is turned off, this unit consumes a small amount of power in order to search for HDMI signals or to receive signals from a network device.



- The front panel display turns on for 3 seconds only when the unit is operated.
- "Dimmer" can adjust the brightness of the front panel display and indicators in the setup menu (p. 77).

The unit (rear)



- So that the HDMI and NETWORK jacks may be easily located, the illustration of the rear of the unit used in this manual shows their respective positions with the labels used on the unit itself.

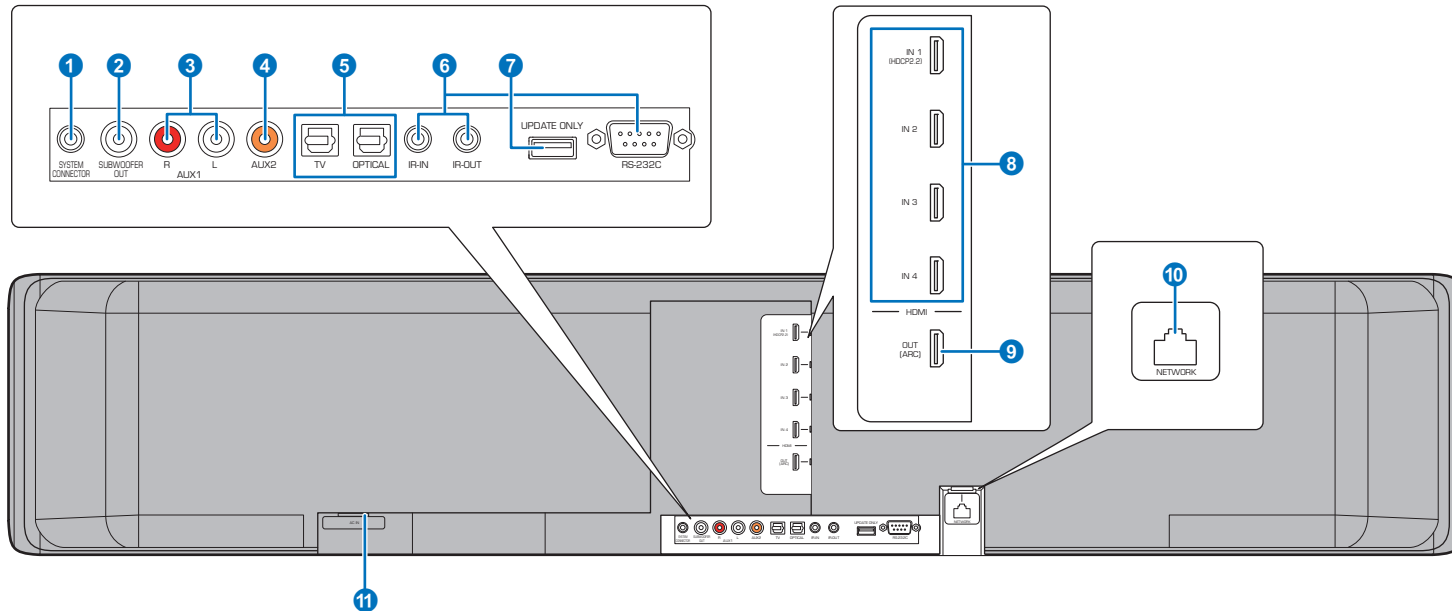

1 SYSTEM CONNECTOR jack

Connect to a Yamaha subwoofer so that the subwoofer functions according to the unit's power on and off (p. 25).

2 SUBWOOFER OUT jack

For connecting to the subwoofer using a wired connection (p. 25).

3 AUX1 analog input jacks

For connecting to a playback device equipped with the analog audio output jacks (p. 24).

4 AUX2 digital coaxial input jack

For connecting to a playback device equipped with a digital coaxial audio output jack (p. 24).

5 TV and OPTICAL jacks

For connecting to a playback device equipped with an digital optical audio output jack (p. 22, 23).

6 IR-IN, IR-OUT, and RS-232C jacks

They are control expansion jacks for commercial use only.

7 UPDATE ONLY jack

Use to update this unit's firmware (p. 87).

8 HDMI IN 1–4 jacks

For connecting an HDMI-compatible playback device such as a BD/DVD player, a satellite and cable TV tuner, and a game console (p. 23).

9 HDMI OUT (ARC) jack

For connecting to an HDMI-compatible TV and outputting video/audio signals (p. 22).

10 NETWORK jack

For connecting to a network with a network cable (p. 51).

11 AC IN jack

Connect the supplied power cable (p. 26).

Remote control

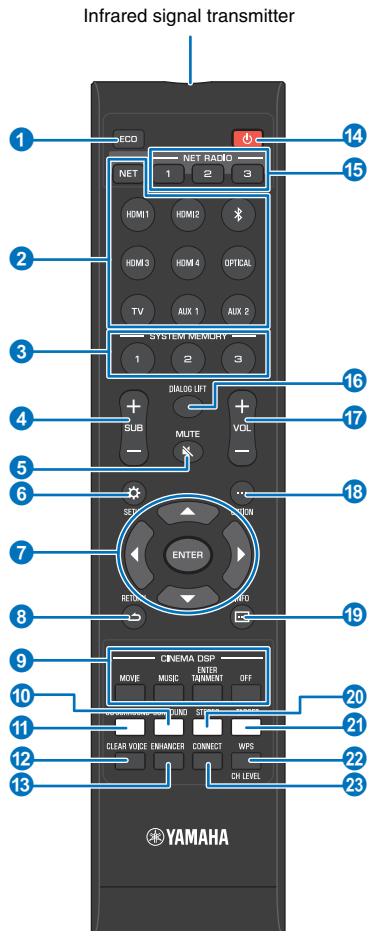

1 ECO key

Turn the Eco function on or off (p. 43).

2 Input selector keys, NET key

Input selector keys

Select an audio input source to be played back (p. 36).

NET key

Select an audio input via a network (p. 49). Each time the key is pressed, the input source is selected as follows:
SERVER → NET RADIO → AirPlay → Streaming music service (if available) → MusicCast Link → SERVER → ...

3 SYSTEM MEMORY keys

Save IntelliBeam measurements, speaker volume, and other settings (p. 44).

4 SUB (+/-) key

Adjust the volume of the subwoofer (p. 36).

5 MUTE (M) key

Mute the sound (p. 36).

6 SETUP (S) key

Display the setup menu (p. 66).

7 ▲/▼/◀/▶ keys, ENTER key

Change the setting (p. 66).

8 RETURN (↶) key

Return to the previous menu screen.

9 CINEMA DSP program keys

When playback is in surround playback mode, select the CINEMA DSP programs (p. 38).

10 SURROUND key

Switch to surround playback mode (p. 38).

11 3D SURROUND key

Switch to 3D surround playback mode (p. 37).

12 CLEAR VOICE key

Turn the CLEAR VOICE function on or off (p. 41).

13 ENHANCER key

Turn Compressed Music Enhancer to on or off (p. 41).

14 ⏻ key

Turn on/off the unit (p. 36).

15 NET RADIO (1–3) keys

Register and play streaming services such as Internet radio stations via the unit (p. 61).

16 DIALOG LIFT key

Use the Dialog Lift function to adjust the height from which dialog is heard (p. 41).

17 VOL (+/-) key

Adjust the volume of the unit (p. 36).

18 OPTION (...) key

Display the option menu for each input source (p. 83).

19 INFO (i) key

Switch the information display on the front panel (p. 43).

20 STEREO key

Switch to stereo playback mode (p. 40).

21 TARGET key

Switch to target playback mode (p. 40).

22 WPS/CH LEVEL key

WPS key

Use the key when connecting to a wireless router (access point) that supports the WPS (push button) feature (p. 53).

CH LEVEL key

Adjust the volume balance during playback (p. 42).

23 CONNECT key

Use to control the unit using the dedicated MusicCast CONTROLLER app for mobile devices. See the MusicCast Setup Guide for details.

PREPARATIONS

General setup procedure

- 1 Installation (p. 12)** Position the unit to achieve the optimal surround sound effects. The unit can also be mounted on a wall.
- 2 Connecting a TV (p. 22)** Connect a TV to the unit.
- 3 Connecting playback devices (p. 23)** Connect video devices (such as BD/DVD players) to the unit.
- 4 Other connections (p. 25)** Connect a subwoofer.
Use a network cable to connect the unit to a router in preparation for wired network connection.
- 5 Connecting the power cable (p. 26)** After all the connections are complete, plug in the power cable.
- 6 Initial settings (p. 27)** Perform initial setup, such as adjusting surround sound effects, before attempting playback.

This completes all the preparations. Enjoy playing movies, music and other content with the unit!



- See "NETWORKS" (p. 49) for information regarding network connection and audio playback via a network.

1 Installation

This unit reflects sound beams off of walls and a ceiling to create the surround sound effect. The position of this unit in relation to the listening position, walls, and a ceiling is important to achieving the desired surround sound effects. Refer to pages 12 to 16 when installing the unit. When installing this unit on a rack behind which there is limited space, for example, it may be easier to connect external devices to this unit first. This will depend upon the installation location. See pages 22 to 25 for information regarding the connection of external devices.

Notes

- Be sure to install this unit on a large, stable stand where it does not fall subject to vibrations, such as from an earthquake, and where it is out of the reach of children.
- There is a built-in antenna on the top of the unit. Do not install it on a metal rack, and do not stack metal items on top of the unit.
- The unit's speakers are not magnetically shielded. Do not install hard disk drives or similar devices near the unit.
- Do not stack the unit directly on top of other playback devices, or vice versa. Heat and vibrations may result in damage or malfunction.

Recommended place for installation

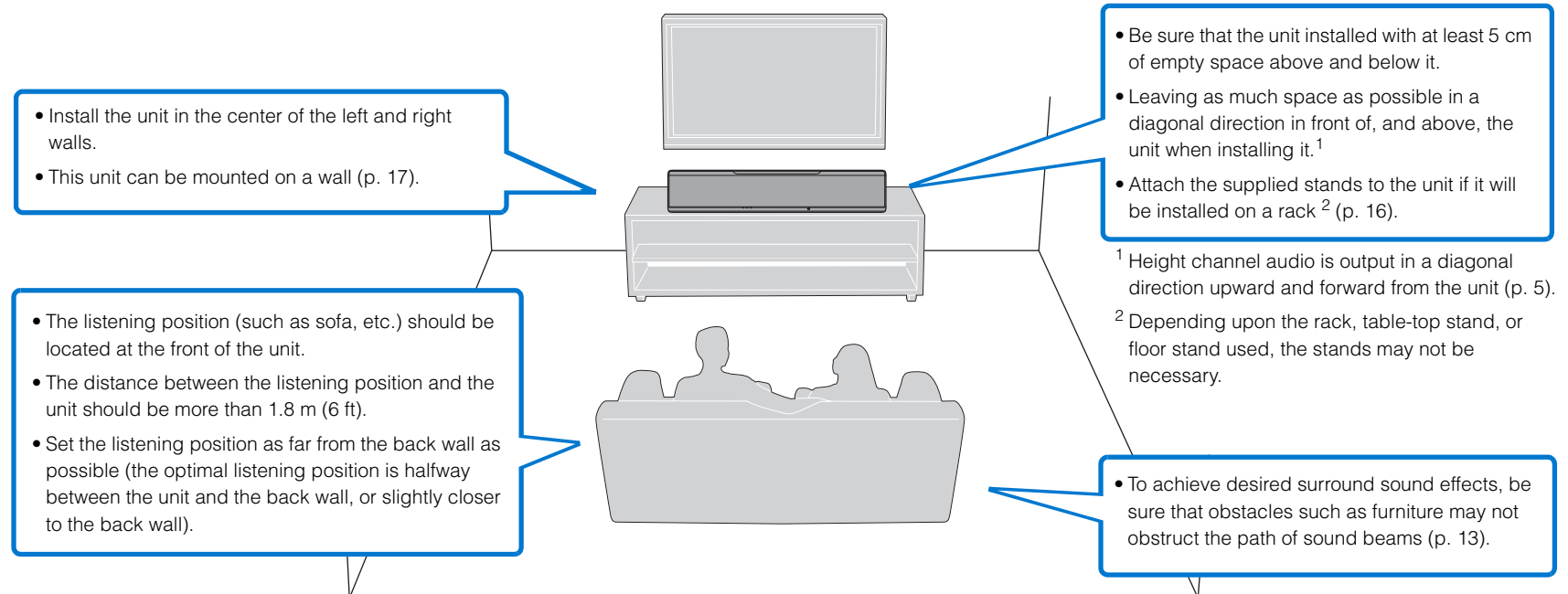

Example for installing the unit

This unit outputs sound beam as shown in the illustrations below. Install this unit where there are no obstacles such as furniture obstructing the path of sound beams. Otherwise, the desired surround sound effects may not be achieved.

If the unit is installed so that it is parallel to a wall, install it as close to the exact center of the wall as possible.

If the unit is installed in a corner of a room, position it at a 40–50° angle to the adjacent walls.

Parallel installation: Viewed from above

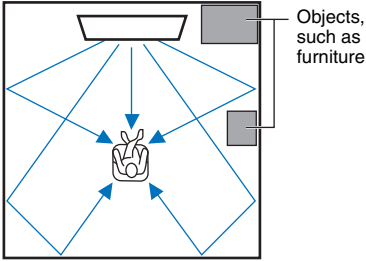

Viewed from the side

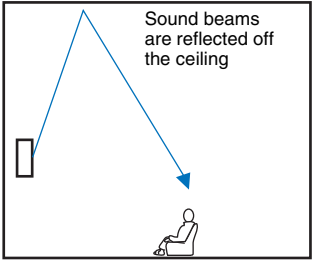

Sound beam output varies depending upon the 3D surround/Surround setting (p. 37, 38) and the channel output setting (p. 72). The illustration above shows the path of sound beams when 3D surround is enabled and “Front” in the Channel Out setting is set to “Beam”.

Corner installation: Viewed from above

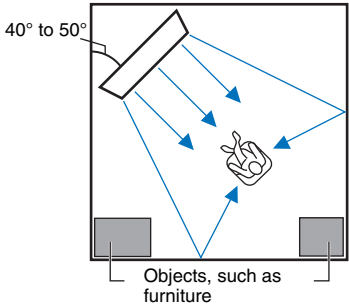

Viewed from the side

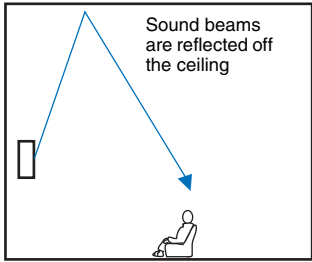

The illustrations above show the path of sound beams when 3D surround is enabled (p. 37) and “Front” in the Channel Out setting is set to “Stereo”. (p. 72).

Parallel installation

Install this unit as close to the exact center of the wall as possible.

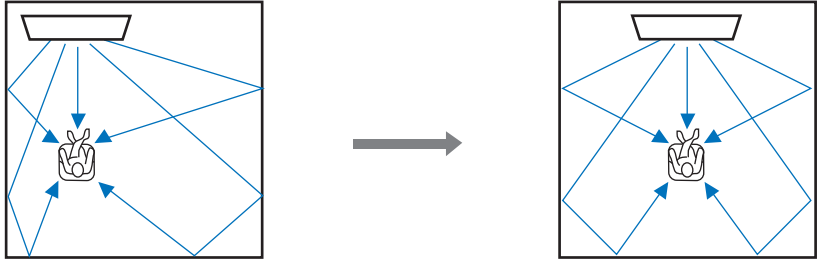

- If the unit cannot be installed evenly between the left and right walls, sound beams can be adjusted to achieve natural surround sound effects (p. 16).

Ideal installation condition

Install this unit as close to the exact front of your normal listening position as possible. The distance between listening position and the unit should be more than 1.8 m (6 ft).

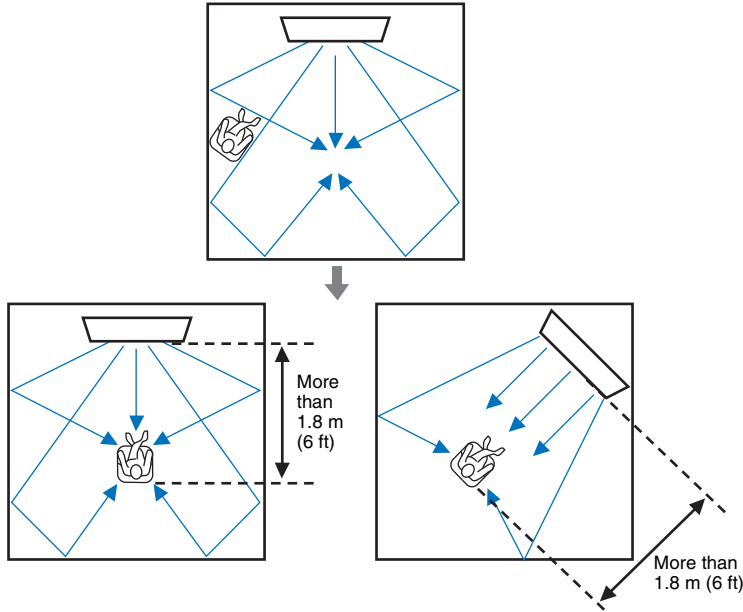

Installing in a non-square room

Install this unit so that the sound beams can be reflected off the walls.

Irregularly shaped rooms with solid walls on all sides

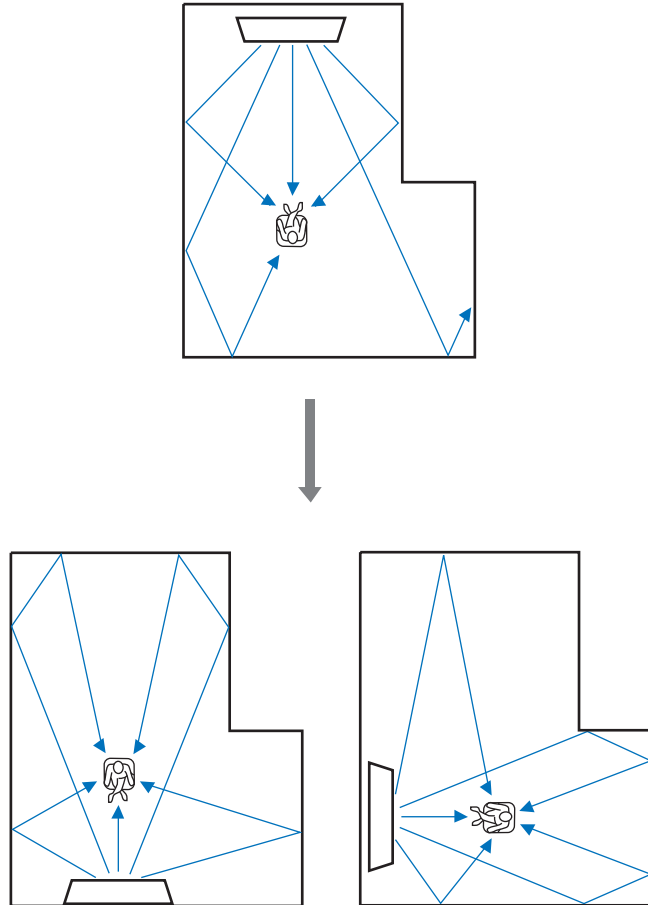

Irregularly shaped rooms that are open to a hallway on one side

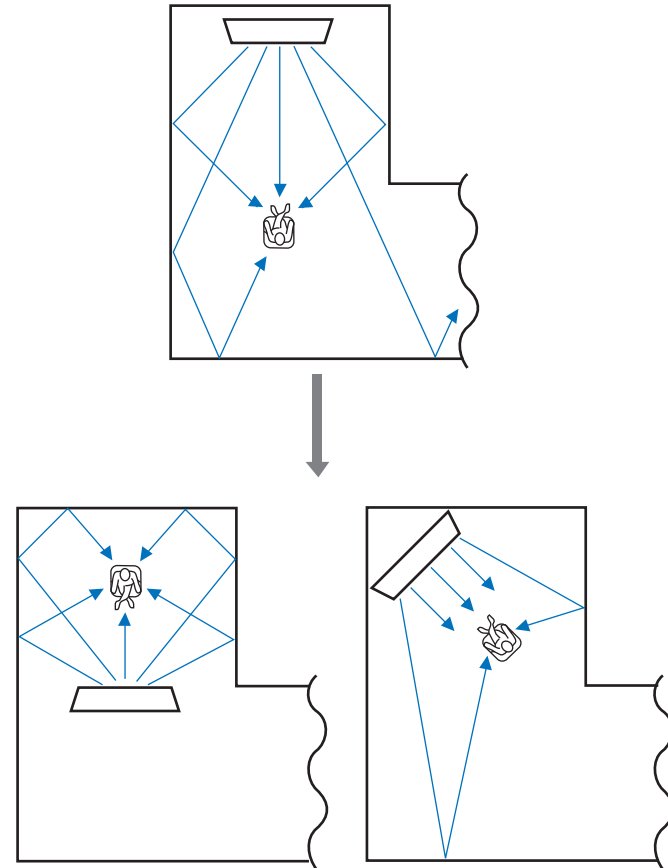

- If this unit cannot be repositioned, or the listening position cannot be changed, the optional YRB-100 sound reflection board may be installed for a better surround sound experience (p. 99).

Example for installing the unit in living room

- The legs on a table are not considered obstacles as sound beams normally pass through them. A cupboard installed facing the wall reflects sounds.
- As the heavy curtains absorb sounds, the sound features of the listening room is different from the case with the curtain opened and the case with the curtain closed. Using saving settings function enables to save the best settings for each case of listening room (p. 44).

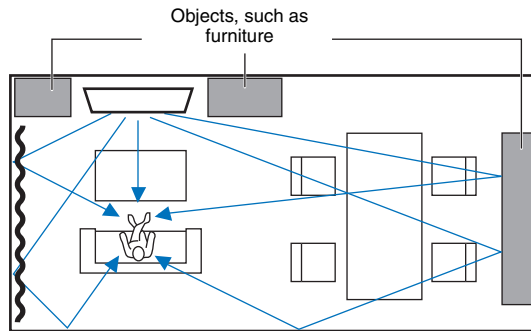

Unrecommended listening environments

This unit creates surround sound by reflecting projected sound beams off the walls and the ceiling of your listening room. The surround sound effects produced by this unit may not be sufficient when this unit is installed in the following locations.

- Rooms with walls inadequate for reflecting sound beams
- Rooms with acoustically absorbent walls and ceiling
- Rooms with measurements outside the following range:
W (3 to 7 m (10 to 23 ft)) × H (2 to 3.5 m (7 to 11.5 ft)) ×
D (3 to 7 m (10 to 23 ft))
- Rooms where objects such as furniture are likely to obstruct the path of sound beams
- Rooms with less than 1.8 m (6 ft) from the listening position to this unit
- Rooms where the listening position is close to the walls
- Rooms where the listening position is not in front of this unit
- Rooms with a complex shape, such as a slanted ceiling (ceiling lights do not obstruct sound beams)

Enjoying surround effects regardless of conditions (My Surround)

The My Surround function creates rich surround sound effects in rooms with less than optimal surround sound conditions. See "Channel Out" (p. 72) for more information.

Adjusting sound beams to achieve optimal surround sound effects

This unit's AUTO SETUP (p. 29) can be used to automatically adjust sound beams to achieve the optimal surround playback environment according to the listening room setup. In addition to using AUTO SETUP, sound beams can be adjusted manually to achieve surround sound effects best suited to the listening room setup when the unit is installed as described below.

Installing the unit near a corner of the room

When installing the unit near a corner of the room as shown in the illustration below, front channel sound may come from an unnatural direction if beam settings are configured using AUTO SETUP.

Should this occur, adjust the left and right front channels using "Image Location" (p. 71) in the setup menu to achieve more natural sound.

When left front channel sound is unnatural

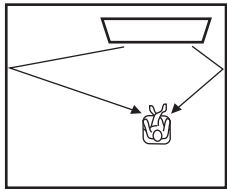

Left front channel adjusted

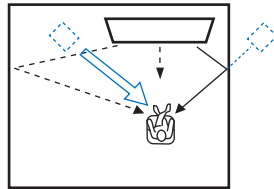

Installing the unit in an irregularly shaped room

When the unit is installed in a room that is not rectangular, sound beams may not be properly reflected off the walls as shown in the illustration below.

Should this occur, perform AUTO SETUP, and then adjust the angle of beam from the channel from which sound is not properly heard using "Horizontal Angle" (p. 69) in the setup menu to achieve even distribution of sound.

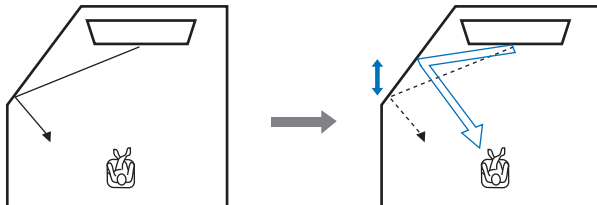

Installing the stands

Install the stands (supplied) on the bottom of the unit. Align and insert the protrusion on the stands into the holes on the rear panel of the unit as shown in the illustration, and then tighten the screws (supplied) to lock the stands in place. The stands need not be installed when the unit is mounted on a wall using the optional Wall Mount Bracket SPM-K30.

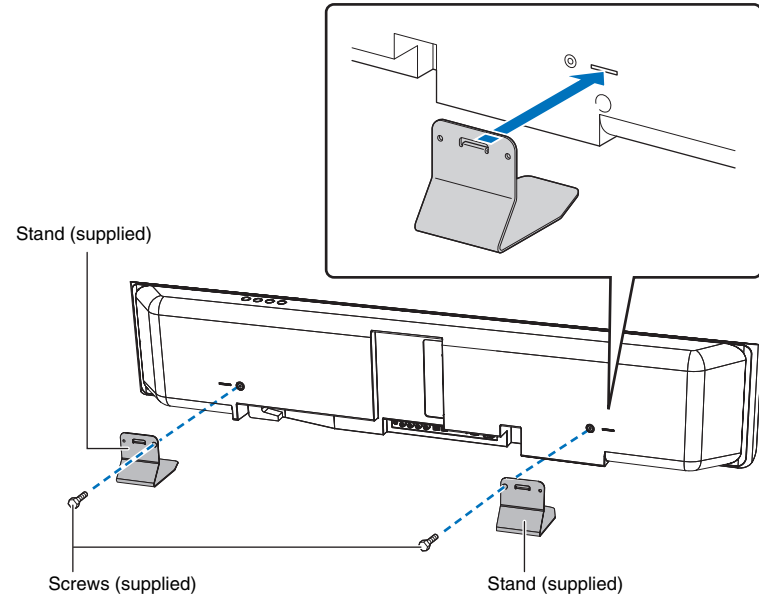

Installing the unit on a rack

The unit can be installed on a shelf, either above or below the TV, on a third-party rack. The rack and the shelf on which the unit is placed should be large enough to allow adequate ventilation around the unit and the rack should be sturdy enough to support the weight of both the unit and the TV.

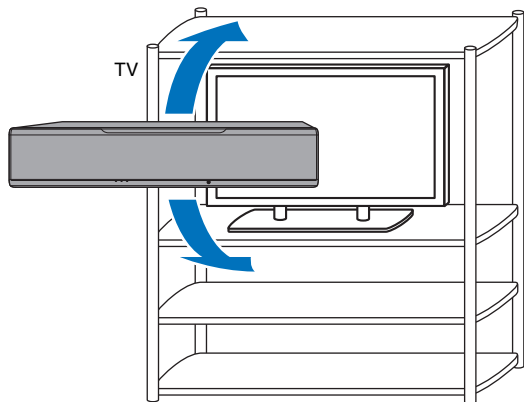

Mounting the unit on a wall

The unit can be mounted on a wall using the optional Wall Mount Bracket (such as SPM-K30).

Notes

Instructions for mounting the unit are not included in the Installation Manual supplied with the SPM-K30. Always follow the instructions provided in this Owner's Manual.

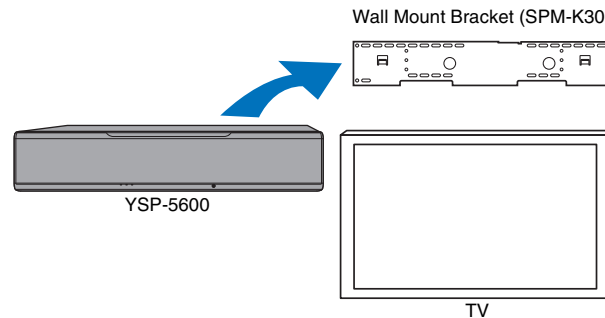

Dimensions when the unit is mounted using the SPM-K30

Be sure to refer to the dimensions below and leave adequate space for ventilation around the unit.

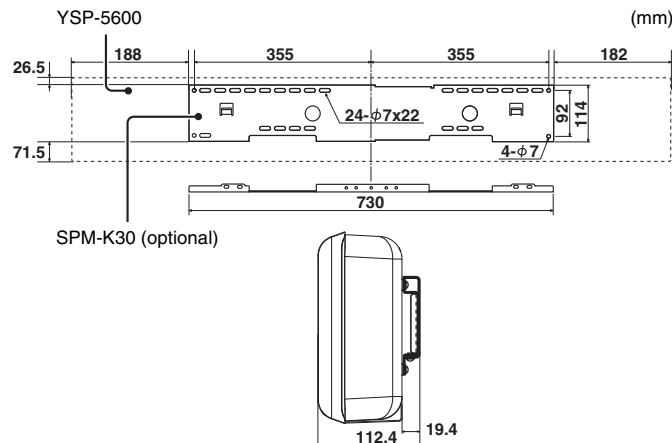



- The SPM-K30 may not be available in some countries or regions.
- When the unit will be installed using the wall mount bracket, all installation work should be performed by a qualified contractor or experienced retail staff. The customer should not attempt to install the unit themselves. Improper installation may cause the unit to fall, resulting in personal injury.
- Installation must be secure enough to bear the weight of the unit and the wall mount bracket, possibly for years to come, and must also be secure enough to withstand vibrations, such as those caused by earthquakes. Improper installation may cause the unit to fall, resulting in personal injury.
- To prevent the unit from falling, attach it to a wall constructed of drywall (plasterboard).
- Be sure to use screws capable of supporting the weight of the wall mount bracket and the unit (with steps 2 and 7). Using items other than the specified screws, such as shorter screws, nails, or double-sided tape, may cause the unit to fall, resulting in personal injury.
- To ensure safety, all screws must be tightened securely. Loose screws may cause the unit to fall, resulting in personal injury.
- Be sure to leave adequate space for ventilation around the unit so that heat generated by the unit is allowed to dissipate. Failure to provide adequate space around the unit may cause the unit to overheat internally, resulting in a fire.
- Do not lean on the unit or apply excessive force to the top of the unit. Doing so may cause the unit to fall, resulting in personal injury.
- Fix cables in place so that they will not become loose. If a foot or hand becomes accidentally entangled in, or catches on, a loose cable, the unit may fall, resulting in personal injury.
- Once the unit is installed, safety checks should be conducted on a regular basis. When the unit is used over an extended period of time, screws can become loose and the installation can weaken due to the passage of time, vibrations, etc.
- Note that Yamaha cannot be held liable for accidents, including falling of the unit, resulting from improper installation of the unit, or for damage to walls.

1 Assemble the large wall mount bracket.

Align the screw holes **A** on the left bracket with those on the right bracket, and tighten the screws.

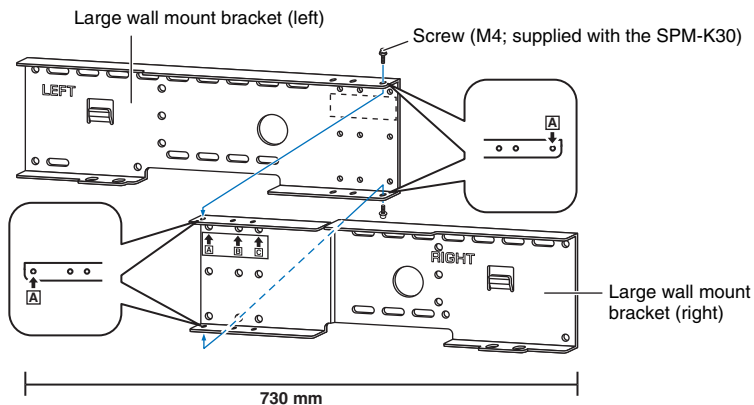

2 Attach the wall mount bracket assembled in step 1 to the wall.

In order to secure the unit to the wall, the bracket must first be attached to the wall in a manner suited to the structure and quality of the wall.

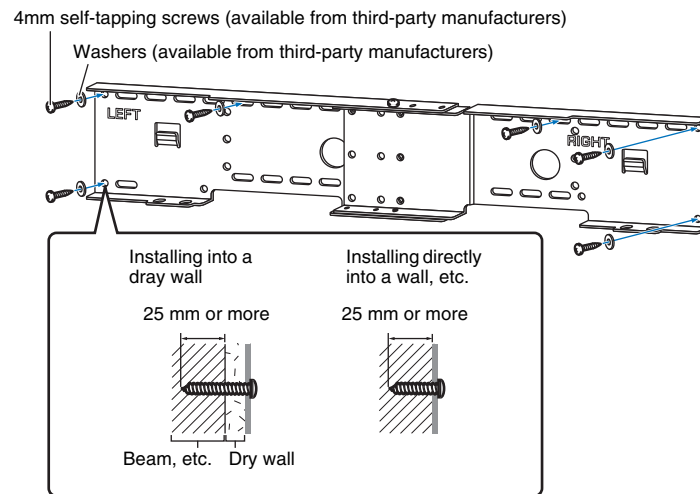

- In order to secure the unit to the wall, drive six (or more) tapping screws from the outside through the holes in the wall mount bracket.

3 Attach the small wall mount brackets to the unit.

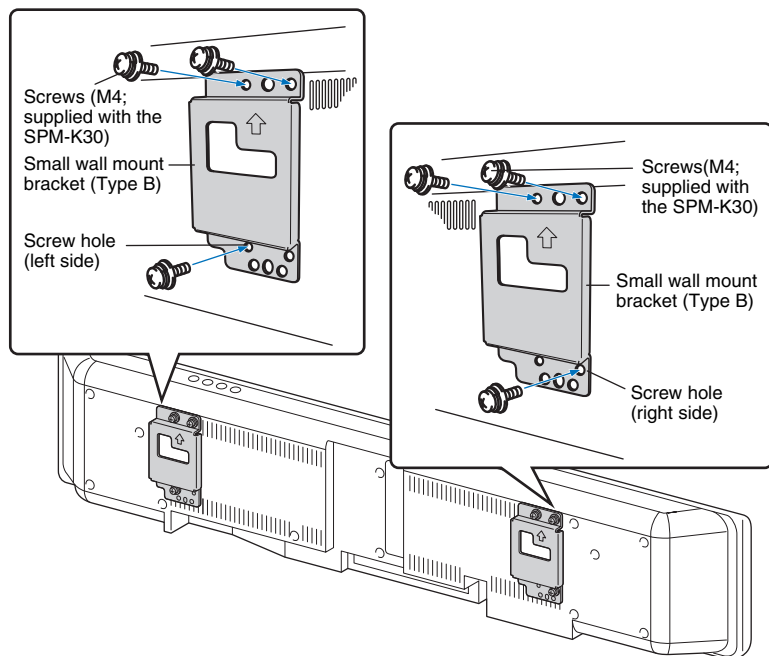

4 Attach the safety wires to the small wall mount brackets (left and right) to prevent the unit from falling.

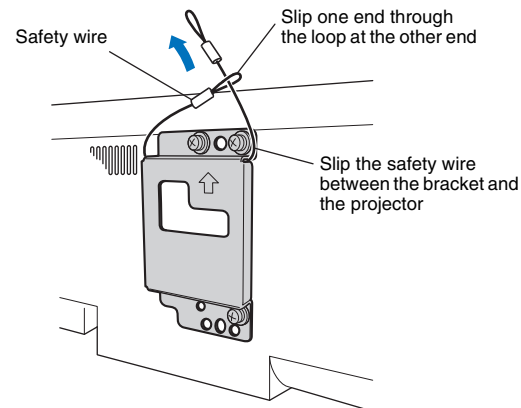

5 Fit the mounting guide hooks of the small wall mount brackets attached to the unit into the holes on the left and right sides of the large wall mount bracket and then slide the unit to the right.

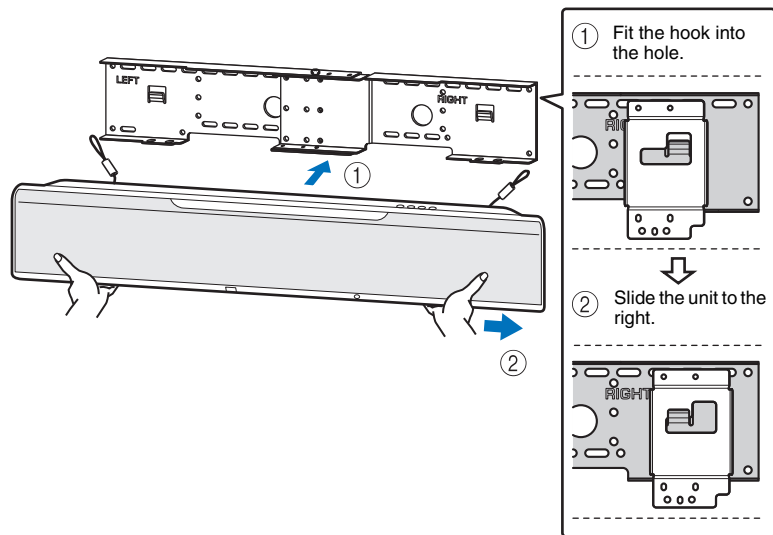

- !**
- Hold the unit tight with both hands when attaching or removing the unit to or from the wall. Holding the unit loosely could cause the unit to fall, resulting in personal injury.

6 Align the holes in the large wall mount bracket with the holes in the bottom of the small wall mount brackets, and then use two of the screws (M6; supplied with the SPM-K30) to secure the unit.

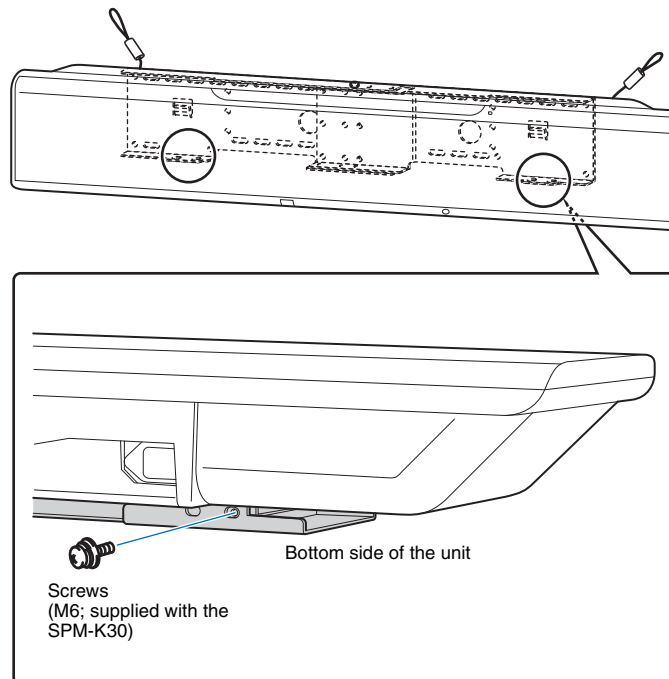

7 Pass the screws through the loops of the safety wires and then tighten the screws to secure the safety wires to the wall.

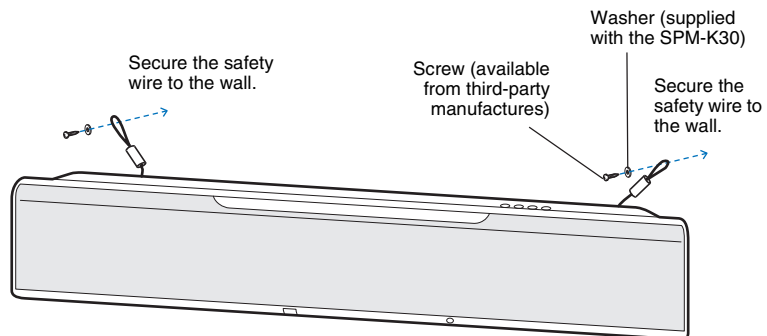

- Attach the safety wires tight.
- Keep the two other washers for future use.

2 Connecting a TV

Connect a TV to the unit so that video input to the unit can be output to the TV. You can also enjoy playback of TV audio on the unit.



- Use a 19-pin HDMI cable with the HDMI logo printed on it. A cable with a maximum length of 5 m is recommended to prevent degradation of signal quality.
- For playback of 3D and 4K video content, use a high-speed HDMI cable.
- This unit supports HDCP version 2.2, a copy protection technology. To enjoy playback of 4K video, connect the unit to the HDMI IN jack (one compatible with HDCP 2.2) on an HDCP 2.2-compliant TV.

TVs that support Audio Return Channel (ARC)

Connect the TV to the unit with an HDMI cable (not supplied).

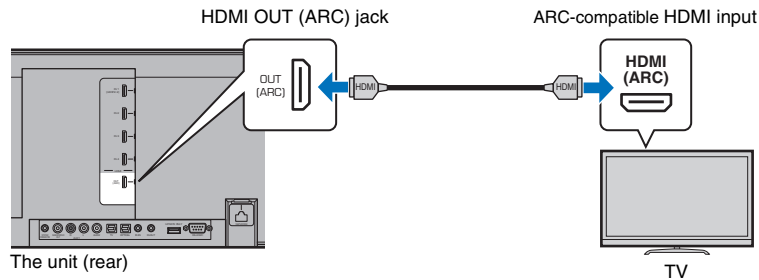

When connecting a TV that supports Audio Return Channel (ARC), enable the HDMI control function (p. 76).

What is Audio Return Channel (ARC)?

In order for the unit to play audio from a TV, the TV must usually be connected to the unit via an audio cable as well as an HDMI cable. If, however, the TV supports Audio Return Channel (ARC), TV audio signals can be input to the unit via the HDMI cable that outputs video signals from the unit to the TV.



- Use an ARC-compatible HDMI cable.

TVs that do not support Audio Return Channel (ARC)

Connect the TV to the unit with an HDMI cable (not supplied) and an optical cable.

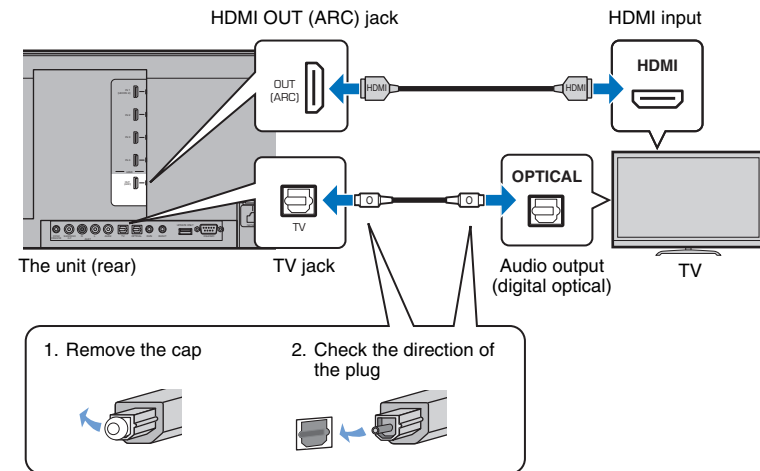

• If the TV has no optical jack

Connect the audio output jack on the TV to the AUX1 (analog) input jack or AUX2 (digital coaxial) jack on the unit, and set "TV Input" in the setup menu to "Analog [AUX 1]" or "Coaxial [AUX 2]" accordingly (p. 76). TV audio can be played through the unit by pressing the TV key on the remote control.

3 Connecting playback devices

Connect video devices such as BD/DVD players, set-top boxes (STBs) and game consoles to the unit. Depending on the video/audio output jacks available on your video device, choose one of the following connections. We recommend using an HDMI connection if the video device has an HDMI output jack.

HDMI connection

Connect a video device to the unit with an HDMI cable (not supplied).



- This unit supports HDCP version 2.2, a copy protection technology. When using an HDCP 2.2-compliant playback device, such as a set-top box, connect it to the unit via the HDMI IN 1 jack. When connecting playback devices that do not support HDCP version 2.2, any HDMI IN jack (1–4) may be used.

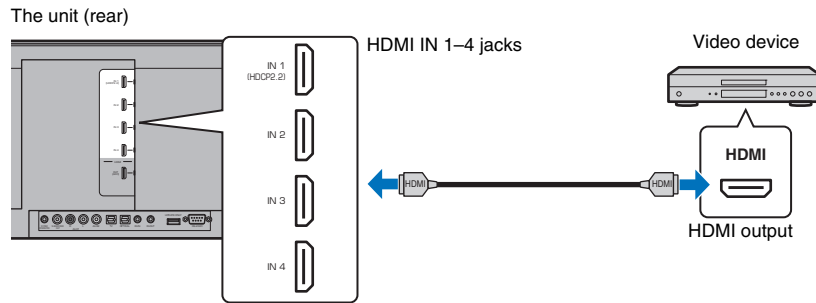

The audio/video played on the video device will be output through the unit by switching input to HDMI 1–4 using the HDMI 1–4 key on the remote control.



- Once the HDMI control function has been activated (p. 34), video and audio content from playback devices can be output from the TV even when this unit is off (HDMI signal pass-through).
- Use a 19-pin HDMI cable with the HDMI logo printed on it. A cable with a maximum length of 5 m is recommended to prevent degradation of signal quality.
- For playback of 3D and 4K video content, use a high-speed HDMI cable.
- When audio from the video device cannot be output via the HDMI jack, use an optical cable to connect the video device to the unit via the digital optical output jack on the video device and the OPTICAL jack on the unit. If the video device is connected to the unit in this way, change "Audio Assign" to "Optical" in option menu (p. 84).

Optical connection

Connect a video device to this unit via the optical cable. Next, connect the video device's video output to the TV's video input.

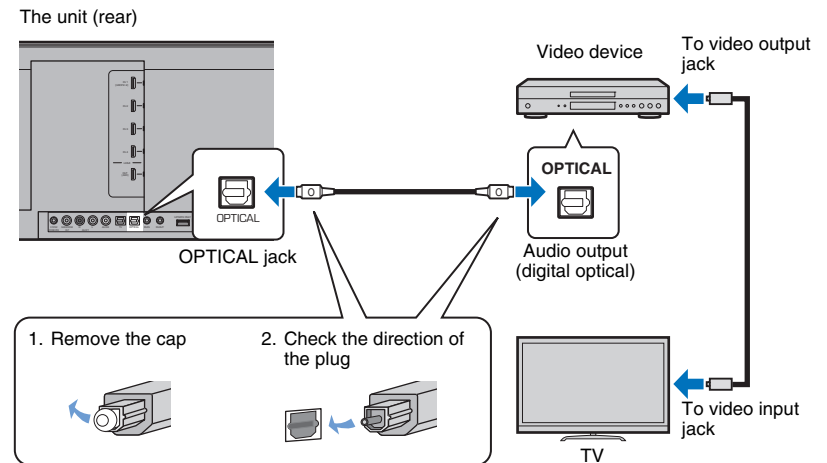

The audio played on the video device will be output through the unit by switching input to OPTICAL using the OPTICAL key on the remote control.

Coaxial connection

Connect a video device to this unit via a digital coaxial cable. Next, connect the video device's video output to the TV's video input.

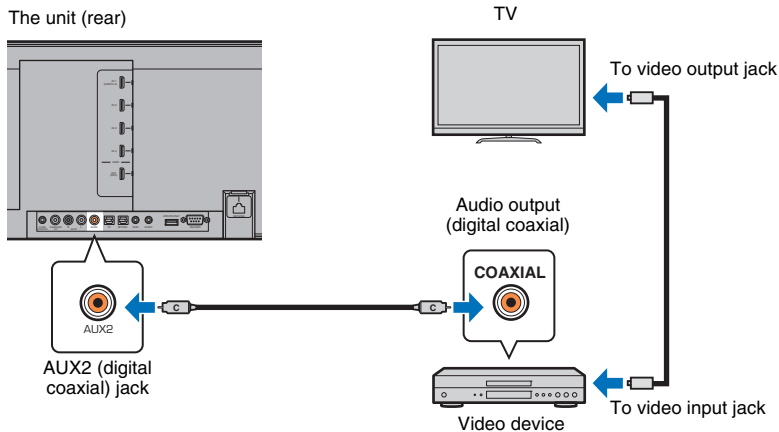

The audio played on the video device will be output through the unit by switching input to AUX2 using the AUX 2 key on the remote control.

Analog connection

Connect a video device to this unit via a stereo cable (not supplied). Next, connect the video device's video output to the TV's video input.

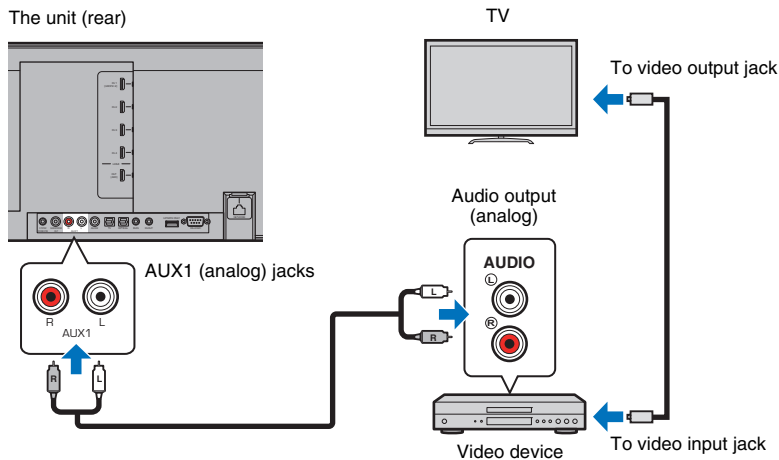

The audio played on the video device will be output through the unit by switching input to AUX1 using the AUX 1 key on the remote control.

4 Other connections

Connecting a subwoofer

A subwoofer can be connected to the unit for use with the unit. There are two ways to connect a subwoofer to the unit: use a third-party RCA monaural cable, or use the optional wireless subwoofer kit SWK-W16 to connect via a wireless connection.

Connecting a subwoofer via cable

Use a third-party RCA monaural cable to connect the subwoofer to the unit via the monaural input jack on the subwoofer and the SUBWOOFER OUT jack on the unit. When connecting a Yamaha subwoofer equipped with a system connector, connect a system control cable (or third-party 3.5mm monaural mini plug cable) to the SYSTEM CONNECTOR on the unit. This connection is required to turn the unit and subwoofer on and off at the same time.

The unit (rear)

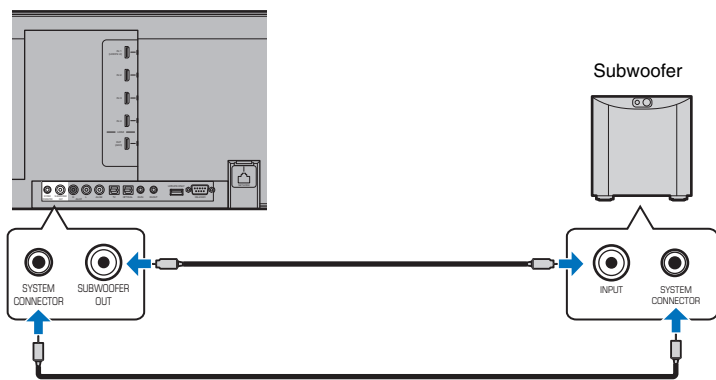

When the unit is connected to the subwoofer via the cable, set the subwoofer output to "Wired" in the setup menu (p. 73)



- See documentation supplied with the subwoofer for more information.

Using the optional wireless subwoofer kit SWK-W16

The optional wireless subwoofer kit SWK-W16 enables wireless connection of a subwoofer to the unit.

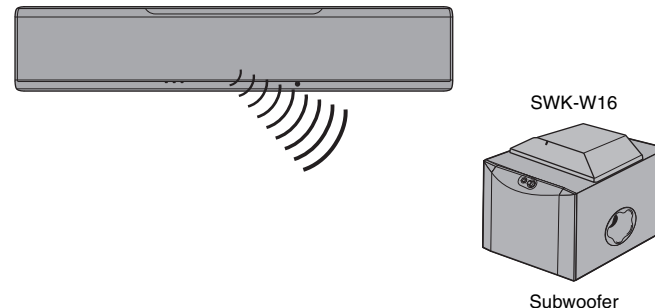

When using the wireless subwoofer kit, set subwoofer output to "Front/Wireless" (default setting) in the setup menu (p. 73).

The unit and the wireless subwoofer kit are automatically connected via wireless connection when the unit is turned on, or when subwoofer output in the setup menu is set to "Front/Wireless".



- See "Troubleshooting" (p. 90) if the indicator on the wireless subwoofer kit does not glow green.
- See the Owner's Manual supplied with the wireless subwoofer kit SWK-W16 for information regarding SWK-W16 and subwoofer connection.
- The wireless subwoofer kit SWK-W16 cannot be used while the subwoofer is connected to the unit via cables.
- The SWK-W16 may not be available in some countries or regions.

Wired network connections

For a wired connection, connect one end of the network cable to the NETWORK jack on the rear panel of the unit and the other end to a router. For details, refer to "NETWORKS" (p. 49).

5 Connecting the power cable

After all the connections are complete, plug in the power cable.

The unit (rear)

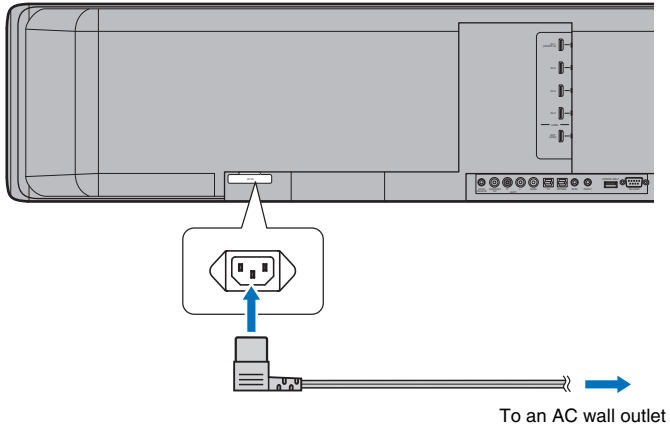

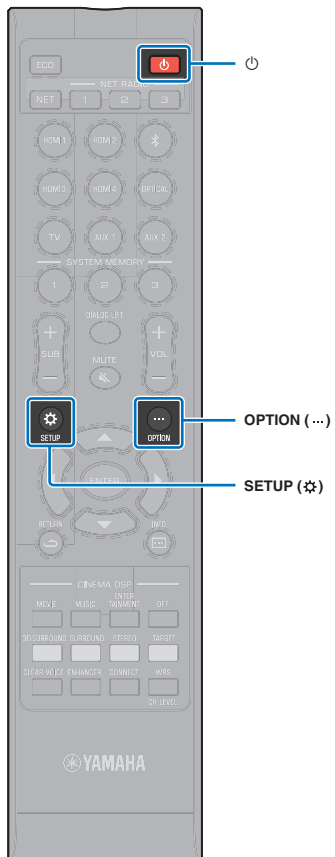

6 Initial settings

Displaying the menu screen on the TV

Visual operation of this unit is possible by displaying its menu screen on the TV.

Turn on the unit and the TV, and then use the input button on the TV's remote control to switch input so that video input from this unit is displayed.

When this unit and the TV are connected as shown below, select "HDMI 1" using the TV's remote control.

TV remote control (example)

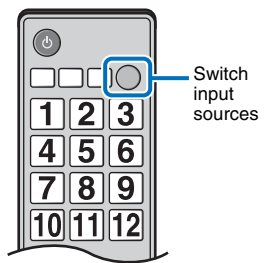

The unit (rear)

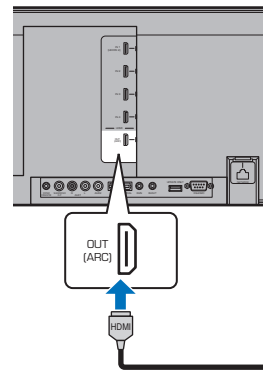

TV

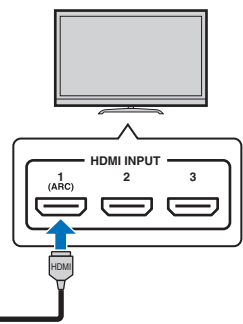

The menu display

The menu is displayed on the TV screen when the SETUP (⚙️) key or OPTION (⋮) key is pressed. When the TV is receiving HDMI signals, the menu is superimposed over video content. Press the SETUP (⚙️) key twice or OPTION (⋮) key a second time to cancel menu display.

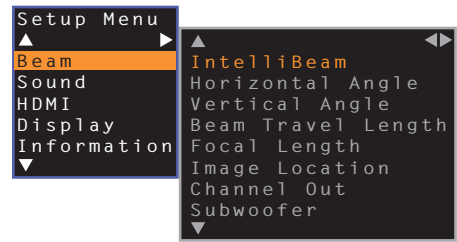

- The setup menu (p. 66) can only be displayed on a TV screen. It cannot be shown in the front panel display.

Initial screen display

When the unit is turned on for the first time after purchase, the screen below will be displayed. ("ViewScreen" is shown in the front panel display.)

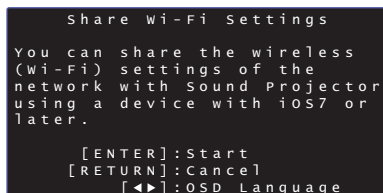

While this screen is displayed, an iOS device (such as an iPhone) can be used to easily connect the unit to a wireless network. See the Quick Reference Guide for more information.

If you will not use an iOS device to connect to a wireless network, press the RETURN (↵) key.



- You can use this function to connect to a wireless network at any time by selecting "Share Wi-Fi Settings (iOS)" from the setup menu. However, be aware that if a different wireless network, or a Bluetooth device, has already been configured, doing so will erase any previous settings.



- This screen will not be displayed if the unit is connected to a router via its NETWORK jack (wired connection).
- Be aware that if the IntelliBeam microphone is connected while the screen shown above is displayed (p. 29), setup will be canceled, and the screen will switch to the auto measurement screen.

Selecting the language for menu display

- 1 Turn the unit and TV on.
- 2 Switch the TV's input to display video input from this unit (p. 27).
- 3 Press and hold the SETUP (⚙) key until the "OSD Language" menu appears on the TV.

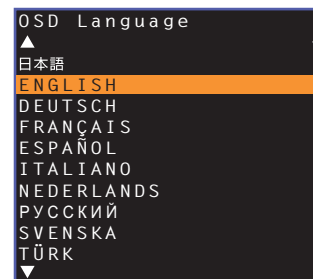

When the menu is not displayed

- Confirm the following cases.
 - The HDMI input jack of your TV and the HDMI OUT (ARC) jack of the unit are connected.
 - The input of your TV is set to "HDMI 1" (example).

- 4 Use the ▲/▼ key to select the desired language and press the ENTER key.

Settings

日本語, ENGLISH (default), DEUTSCH, FRANÇAIS, ESPAÑOL, ITALIANO, NEDERLANDS, РУССКИЙ, SVENSKA, TÜRK

- 5 Press the SETUP (⚙) key to exit the setup menu.

Auto setup for appropriate surround effects (IntelliBeam)

First use the “IntelliBeam” function to adjust each channel so that this unit provides the optimal viewing and listening environment.



- The AUTO SETUP procedure may not be run successfully if this unit is installed in one of the rooms described in “Unrecommended listening environments” (p. 15).
- In order for this unit to provide the optimal listening environment, adjust each channel first using the “IntelliBeam” function. The My Surround function can be used to enjoy rich surround sound in these types of rooms as well. See “Channel Out” (p. 72) for more information.
- Do not connect the IntelliBeam microphone to an extension cable as doing so may result in an inaccurate sound optimization.

Installing the IntelliBeam microphone

1 Place the IntelliBeam microphone at your normal listening position.

2 Assembling the supplied cardboard microphone stand

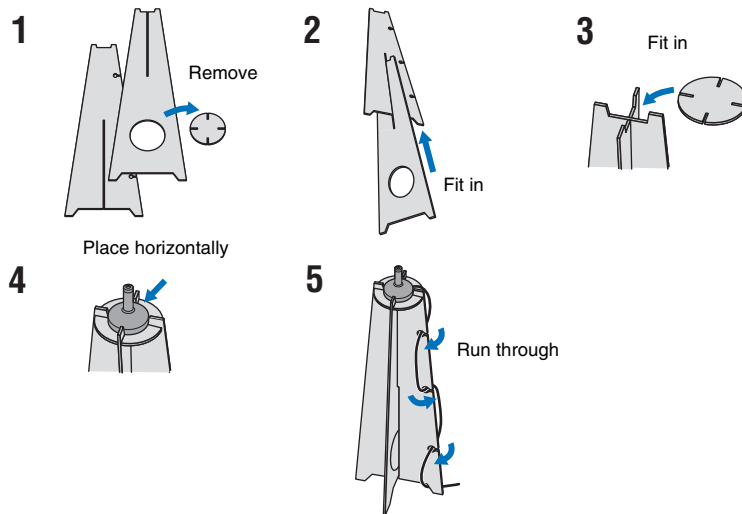

- Use the supplied cardboard microphone stand or a tripod to place the IntelliBeam microphone at the same height as your ears would be when you are seated.
- Position the IntelliBeam microphone so that it is parallel with the floor.

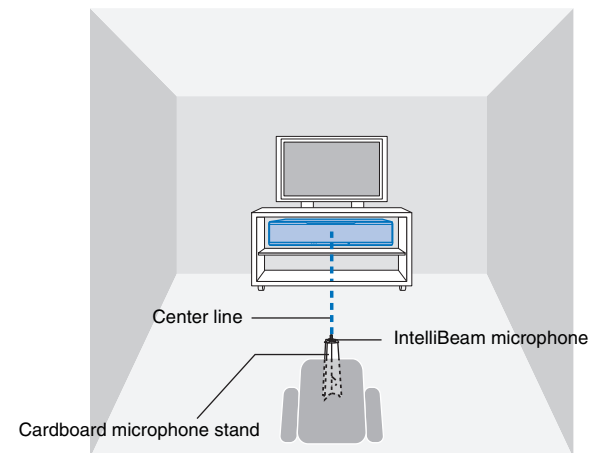
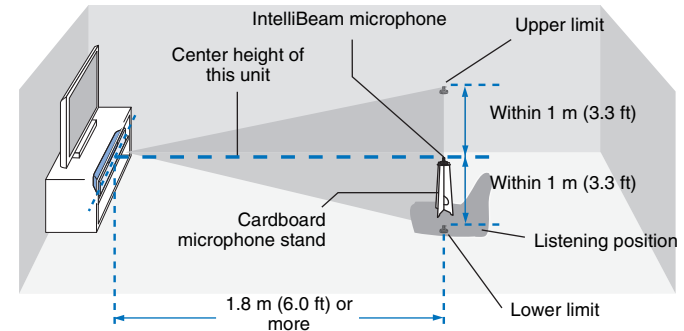

Make sure that there are no obstacles between the IntelliBeam microphone and the walls in your listening room as these objects obstruct the path of sound beams. However, any objects that are in contact with the walls will be regarded as a protruding part of the walls.

Using AUTO SETUP (IntelliBeam)



- Test tones output during measurement are loud. Perform AUTO SETUP when no children are around and there is no possibility of their entering the listening room, as their hearing may be impaired.
- If there are curtains in your listening room, we recommend following the procedure below.
 1. Open the curtains to improve sound reflection.
 2. Run “Beam optimize only” (p. 32).
 3. Close the curtains.
 4. Run “Sound optimize only” (p. 32).
- Make sure that your listening room is as quiet as possible. For accurate measurement, turn off air conditioner or other devices that make noises.

1 Turn the unit and your TV on.



- When a subwoofer is connected to the unit, turn on the subwoofer, and set the volume and crossover frequency as shown below.

Set the volume to half

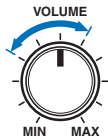

Set the crossover frequency to maximum



2 Switch TV input to display video input from this unit (p. 27).

3 Connect the IntelliBeam microphone to the INTELLIBEAM MIC jack of the unit.

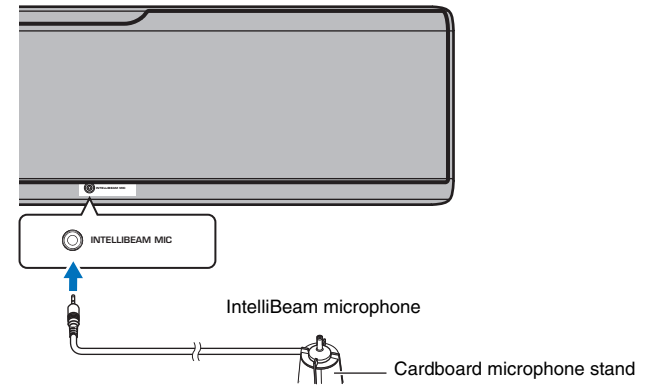

The screen below is displayed after connecting IntelliBeam microphone to the unit.

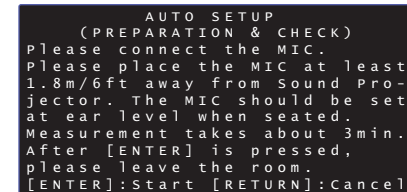

“AUTO SETUP” in the “IntelliBeam” menu can automatically adjust the following two settings.

Beam optimize only	This feature optimizes the beam angle so that the parameter best matches your listening environment.
Sound optimize only	This feature optimizes sound quality for each channel by measuring the acoustic characteristics of the listening environment.

“Beam optimize only” or “Sound optimize only” can be measured separately in the setup menu (p. 32).



- Follow the instructions below and then leave the room. If you remain in the room, you may obstruct the beam, or the microphone may pickup any sounds you make, possibly resulting in improper measurement.

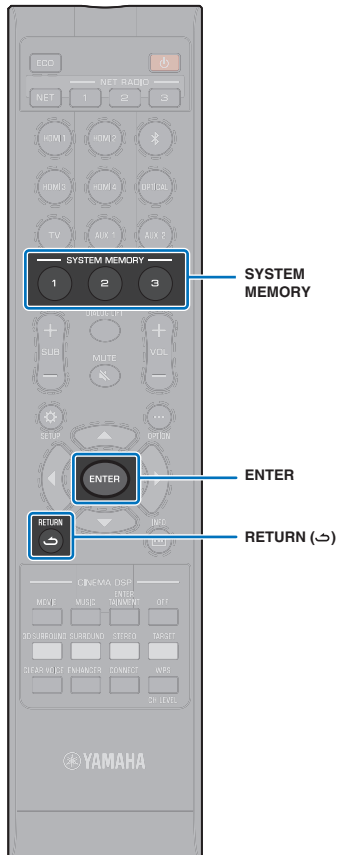

4 Press the ENTER key to start the AUTO SETUP procedure and then leave the room within 10 seconds.

```

AUTO SETUP START
will begin in 10 sec.
Please leave the room.
-----
[RETURN]:Cancel
  
```

The screen changes automatically as measurement progresses.

```

SHOW RESULT
MEASUREMENT COMPLETE.
ENVIRONMENT CHECK:Success
FRONT :Beam
SURROUND :Beam
SUBWOOFER:wired
[ENTER]:Save set-up.
[RETURN]:Do not save set-up.
  
```

If the AUTO SETUP procedure is complete, this unit rings the chimes.



- The AUTO SETUP procedure takes about 3 minutes.
- To cancel the AUTO SETUP procedure after it is started, or if you do not want to apply the results, press the RETURN (↵) key.
- If an error occurs, an error buzzer sounds and an error message is displayed. For details on error messages, see "If an error message is displayed" (p. 33).

5 Press the ENTER key.

The measurement results are applied and saved in the unit.

```

AUTO SETUP COMPLETE

Please remove the MIC
from Sound Projector
and the listening position.

Press [SYSTEM MEMORY] key
to save set-up in the memory.
  
```

- You can save several measurement results by pressing the SYSTEM MEMORY 1, 2, or 3 key. When the SYSTEM MEMORY 1 key is pressed, "M1 Saving" is displayed, and settings are saved.
- If ambient noise is picked up after measurement begins, an error message is displayed in the "AUTO SETUP COMPLETE" screen prompting you to begin measurement again. Press the ENTER key to exit the error message screen, and begin measurement again.



- See page 44 for more information on the system memory function.

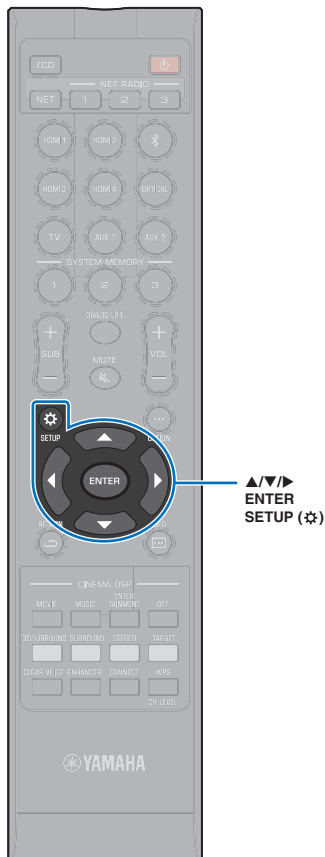

6 Remove the IntelliBeam microphone.

The “AUTO SETUP COMPLETE” screen closes.

The IntelliBeam microphone is sensitive to heat, so should not be placed anywhere where it could be exposed to direct sunlight or high temperatures (such as on top of AV equipment).

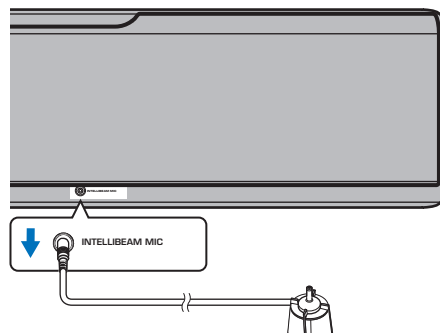

□ AUTO SETUP via the setup menu

“Beam optimize only” or “Sound optimize only” can be measured separately in the setup menu.

1 Place the IntelliBeam microphone at your normal listening position, and press the SETUP (⚙️) key.

See “Installing the IntelliBeam microphone” (p. 29) for instructions on positioning the IntelliBeam microphone.

2 Press the ▲/▼ key to select “Beam” and then press the ENTER key.

3 Press the ▲/▼ key to select “IntelliBeam” and then press the ENTER key.

4 Press the ▲/▼ key to select one of the items below and then press the ENTER key.

Settings

Beam+Sound optimize	Select this optimization feature if you make settings for the first time. This menu takes about 3 minutes.
Beam optimize only	Use to optimize the beam angle so that the parameter best matches your listening environment. This menu takes about 1 minute.
Sound optimize only	Use to optimize the beam delay, volume, and quality so that the parameters best match your listening environment. This menu takes about 2 minutes. You must optimize the beam angle with “Beam optimize only” before starting “Sound optimize only”. Select this optimization feature in the following cases: <ul style="list-style-type: none"> • If you have opened or closed the curtains in your listening room before using this unit • If you have manually set the beam angle with “Beam optimize only”.

5 Connect the IntelliBeam microphone to this unit after “AUTO SETUP (PREPARATION & CHECK)” screen is displayed.

For details on connecting IntelliBeam microphone, refer to “Using AUTO SETUP (IntelliBeam)” (p. 30).

6 Follow steps 4, 5, and 6 under “Using AUTO SETUP (IntelliBeam)” to configure settings, and then remove the microphone.



- When the AUTO SETUP procedure is performed from the setup menu, the menu selection screen of the setup menu appears. Press the SETUP (⚙️) key twice to exit the setup menu.

❑ If an error message is displayed

If an error message is displayed on the TV screen, see “Error messages” below to determine the cause and resolve the problem. Follow the instructions displayed on the TV screen to begin measurement again.

Error messages

Error message		Cause	Remedy
ERROR E-1	Please test in quieter environment.	There is too much noise in your listening room.	Turn off devices, such as an air condition, that make noise, or move the unit away from such devices. You may want to choose certain hours during the day when there is not much noise coming from outside.
ERROR E-2	No MIC detected. Please check MIC connection and re-try.	The IntelliBeam microphone is disconnected.	Connect the IntelliBeam microphone to the INTELLIBEAM MIC jack on the front of this unit and begin measurement again.
ERROR E-3	Unexpected control is detected. Please re-try.	Some other operations were performed on this unit.	Begin measurement again. Do not perform any other operations with this unit during measurement.
ERROR E-4	Please check MIC position. MIC should be set in front of Sound Projector. Please re-try.	The IntelliBeam microphone is not placed in front of this unit.	Position the IntelliBeam microphone in front of this unit and begin measurement again.
ERROR E-5	Please check MIC position. MIC should be set above 1.8m/ 6.0ft and re-try.	The IntelliBeam microphone is not placed in the right distance from this unit.	Position the IntelliBeam microphone at a distance of more than 1.8 m (6.0 ft) from this unit and begin measurement again.
ERROR E-6	Volume level is lower than expected. Please check MIC position/connection and re-try.	The IntelliBeam microphone cannot collect the sound produced by this unit.	Position the IntelliBeam microphone properly, check the connection, and then begin measurement again.
ERROR E-7	Unexpected error happened. Please turn off and re-try.	An internal system error occurred.	Press the  key to turn off this unit, then run AUTO SETUP procedure again after turning this unit on.
ERROR E-9	Please check the connection with subwoofer.	The subwoofer output signals cannot be recognized.	Confirm the connection between the wireless subwoofer kit and subwoofer (p. 25), and begin measurement again.

Operating the unit by TV's remote control (HDMI control)

What is the HDMI control function?

HDMI control allows you to operate external devices via HDMI. If you connect a TV that supports HDMI control to the unit with an HDMI cable, you can control the unit (such as power and volume) with TV remote control operations. You can also control playback devices (such as HDMI control-compatible BD/DVD players) connected to the unit with an HDMI cable.

Coordinated functions via the TV remote control

Remote control of TV (Example)

1. Turn on/off

Both the TV and this unit turn on/off at the same time.

2. Switch input sources

- The unit's input source switches accordingly when the TV's input source is switched.
Examples
 - When a TV program is selected on the TV, the unit's audio input source is switched to the HDMI OUT (ARC) jack using the ARC function or TV jack.
 - When a Blu-ray disc player connected to the HDMI IN 1 jack on the unit is selected, the unit's input source also switches to HDMI 1.
- The input source can be switched while the unit is off.

3. Switch the audio output device (TV or this unit (amplifier))

4. Adjust volume

This unit's volume can be adjusted when the TV's audio output is set to this unit (amplifier).

5. HDMI signal pass-through

HDMI input signals are output from the HDMI OUT (ARC) jack. Video and audio contents from an HDMI input source are output from the TV when the unit is turned off.

6. ARC function

Audio signals output from the HDMI (ARC) jack on the TV can be input to the HDMI OUT (ARC) jack on the unit (p. 22).

In addition to the functions in the left column, the unit's menus displayed on the TV can be operated with some TV.



- Even if your TV supports the HDMI control function, some functions may not be available. For details, refer to documentation supplied with your TV.
- We suggest using devices (TV, BD/DVD player, etc.) from the same manufacturer.

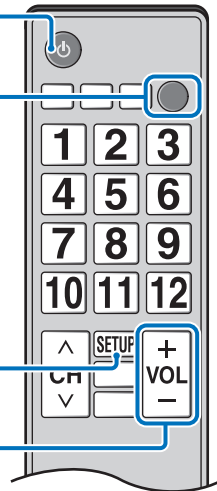

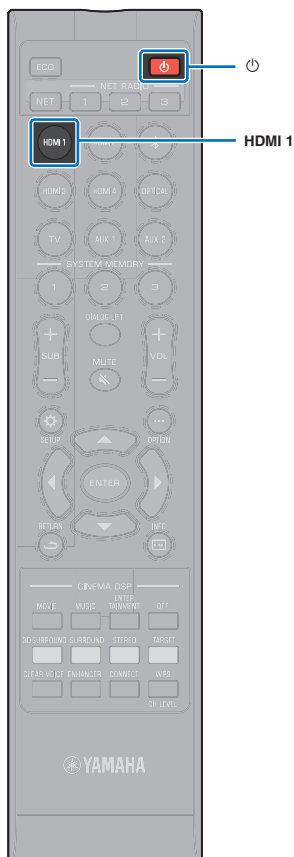

Setting the HDMI control function

- 1 Turn on the unit, TV, and playback devices.
- 2 Activate the HDMI control function on the unit, TV, and playback devices such as BD/DVD players that support this function.
For this unit, set “HDMI Control” to “On”. The default setting is “Off” (p. 76).
For playback devices, refer to documentation supplied with each device.
- 3 Turn off the main power of the TV and then turn off the unit and playback devices.
- 4 Turn on the unit and playback devices and then turn on the TV.
- 5 Switch the TV input to display the video from the unit.
- 6 Select HDMI 1-4 as an input source and confirm that the video of the playback device is displayed on the TV.

When the playback device is connected to the HDMI IN 1 jack, press the HDMI1 key.

HDMI 1 — Input source name

- 7 Check that the unit is properly coordinated with the TV by turning off the TV or adjusting the TV volume with the TV remote control.

If devices are not coordinated

Confirm the settings are properly configured as described below.

- “HDMI Control” (p. 76) is set to “On” in the setup menu.
- The HDMI control function is enabled on the TV.

The example of TV settings

- From the setup menu on your TV, select “Link setting” → “HDMI control setting”, then set a setting such as “HDMI control function” to “ON”.
- Set audio output to any option other than TV.

If devices fail to coordinate even after the settings described above have been applied correctly:

- Turn off this unit and the TV, and then turn them back on again.
- Disconnect the power cable of the unit and external devices connected to the unit via HDMI cable. Plug them in again after about 30 seconds.
- If devices fail to coordinate after OPTICAL, AUX1, or AUX2 is input, repeat steps 5 and 6 under “Setting the HDMI control function”.

Changing the connection method and connected devices

When changing connected devices, or the jacks via which devices are connected, reconfigure settings as follows.

- 1 Disable the HDMI control function of the TV and BD/DVD player, turn off all connected devices, and change the connections.
- 2 Perform steps 1 to 7 of “Setting the HDMI control function”.

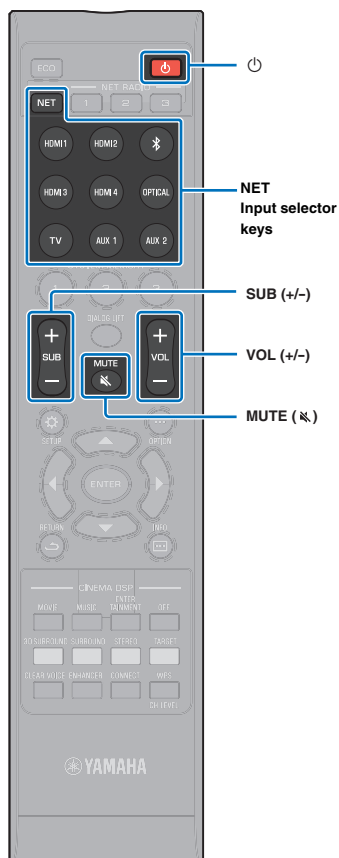

PLAYBACK

Basic operation for playback

- 1 Press the key to turn on this unit.
- 2 Turn on devices (TV, BD/DVD player, game console, etc.) connected to this unit.
- 3 Select a device by pressing the input selector key or NET key corresponding to the connection of external devices.

Press the HDMI1 key to play audio/video content from a BD/DVD player connected via the HDMI IN1 jack.

HDMI 1 _____ Input source name

For playback from a *Bluetooth* device, refer to p. 45. For audio playback via a network, refer to p. 60 to 65.

- 4 Play back a device selected in step 3.

- 5 Press the VOL (+/-) key to adjust the volume. Press the SUB (+/-) key to adjust the volume of the subwoofer.

- When audio is output from both TV speaker and this unit, mute the TV sound.
- When sound input to HDMI IN jack is output from the TV, the volume level does not change even if you press the VOL (+/-) key or the MUTE (🔇) key.
- To mute the sound, press the MUTE (🔇) key. "MUTE ON" is shown in the front panel display. To resume the volume, press the MUTE (🔇) key again or press VOL (+/-) key. "MUTE OFF" is shown in the front panel display.



- The subwoofer volume can be adjusted separately from the whole volume.
- Lowering the subwoofer volume is recommended at night.

- 6 Select 3D surround playback, surround playback, stereo playback, or target playback mode, and configure sound setting according to your preferences (p. 37).

Press the key to turn off this unit after use.

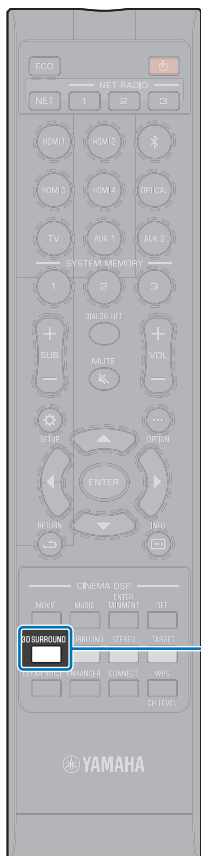

3D SURROUND

Enjoying sound based on your preference

This unit supports the following capabilities to enjoy sound based on your preference.

- 3D surround playback mode
- Surround playback mode (p. 38)
- CINEMA DSP (p. 38)
- Stereo playback mode (p. 40)
- Target playback mode (p. 40)
- Compressed Music Enhancer (p. 41)
- CLEAR VOICE (p. 41)
- Volume adjustment for each channel (p. 42)

Playback with 3D surround sound

In addition to 5-channel sound beams used for surround sound playback in the horizontal direction, surround sound can be heard from above by directing two sound beams (from height channels) upward and reflecting them off the ceiling. Compared to surround sound playback in only the horizontal direction, this gives the sound field (spatial expression with sounds) a greater sense of immersion and reality.

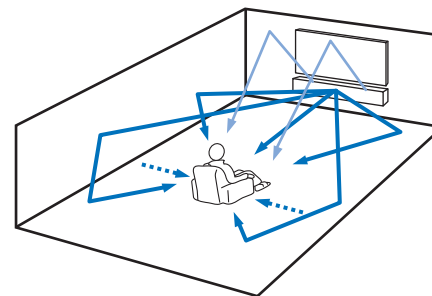

- ← Sound beams in the horizontal direction
- ← Sound beams output from height channels
- ←···· Channels created from the front and rear sound beams (p. 72)

1 Press the 3D SURROUND key to switch to 3D surround mode.

“3D SUR.” is shown in the front panel display.

3D SUR.



- Configuring Channel Out settings (p. 72) in the setup menu allows for more precise configuration of beam settings in accordance with the audio source and listening room setup.

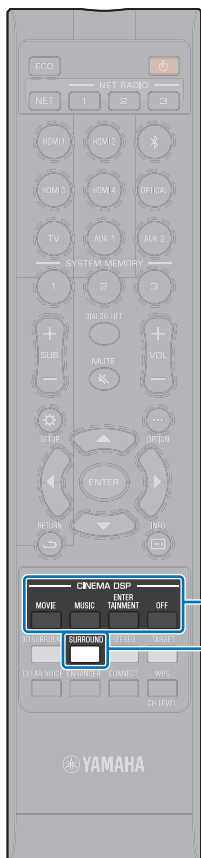

CINEMA DSP

SURROUND

Playback with surround sound

5-channel sound beams create a sound field for surround sound playback without using height channel sound beams.

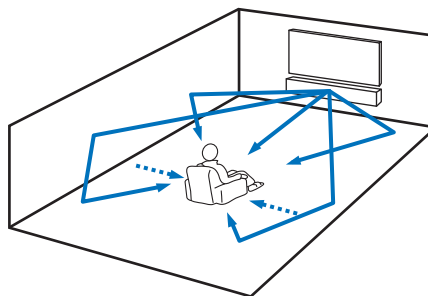

← Sound beams

←····· Channels created from the front and rear sound beams (p. 72)

1 Press the SURROUND key to switch to surround mode.

“SURROUND” is shown in the front panel display.

SURROUND



- Configuring Channel Out settings (p. 72) in the setup menu allows for more precise configuration of beam settings in accordance with the audio source and listening room setup.
- Use 3D surround sound playback mode for playback of audio fed via height channels such as with Dolby Atmos.

Enjoying three-dimensional surround sound (CINEMA DSP 3D/CINEMA DSP)

Select the desired CINEMA DSP program according to the audio source and your preferences. Yamaha's exclusive sound field reproduction technology (CINEMA DSP 3D/CINEMA DSP) easily reproduces realistic sound fields comparable to those found in movie theaters and concert halls, allowing users to enjoy a natural and three-dimensional listening environment.

Sound fields are reproduced using CINEMA DSP 3D for 3D surround sound playback, and CINEMA DSP for surround sound playback. The same programs can be selected for both CINEMA DSP 3D and CINEMA DSP.

1 Press the CINEMA DSP (MOVIE, MUSIC, or ENTERTAINMENT) key repeatedly to select the desired program.

The CINEMA DSP program name appears in the front panel display.



- The CINEMA DSP programs are not available in the following conditions.
 - In stereo playback mode (p. 40) or target playback mode (p. 40)
 - When using My Surround function (p. 73).
- This unit automatically memorizes the settings assigned to each input source. When you select another input, the unit automatically recalls the last settings for the selected input.

CINEMA DSP 3D

In addition to two-dimensional sound fields reproduced with standard CINEMA DSP, CINEMA DSP 3D applies measured three-dimensional sound field data, including vertical directional information, for reproduction of three-dimensional sound fields.

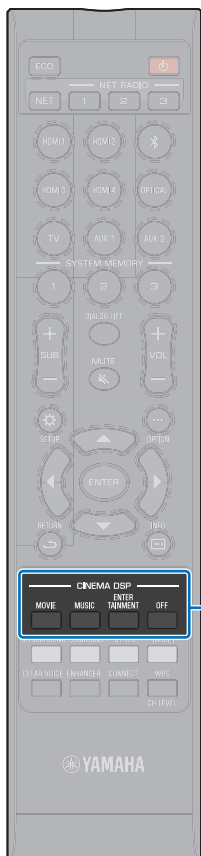

CINEMA DSP

□ CINEMA DSP 3D/CINEMA DSP options

MOVIE (use the MOVIE key to select)

Sci-Fi	This program clearly reproduces dialogs and special sound effects of the latest science fiction films and lets you feel a broad and expansive cinematic space.
Adventure	This program reproduces the thrilling environment of the latest action films and lets you feel the dynamic and excitement of fast-moving scenes.
Spectacle	This program reproduces the wide and grand environment and lets you have added impressions on spectacular scenes with strong visual impacts.

MUSIC (use the MUSIC key to select)

Music Video	This program produces a vibrant environment and lets you feel as if you are at an actual jazz or rock concert.
Concert	This program creates a rich surround effect of a large round concert hall with a great deal of presence, emphasizing the extension of sounds, and lets you feel as if you are seated close to the center of the stage.
Jazz Club	This program recreates the acoustic environment of "The Bottom Line", a famous jazz club in New York once and lets you feel as if you are seated right in front of the stage.

ENTERTAINMENT (use the ENTERTAINMENT key to select)

Sports	This program reproduces the energetic environment of live sports broadcasting, converging a commentator's voice on the center and broadening the overall atmosphere of the stadium, and lets you feel as if you are seated at an actual stadium or a ball park.
Talk Show	This program reproduces excitement of live talk shows. It enhances the ambience of gaiety while keeping the conversations at a comfortable volume.
Drama	This program stables reverberations that match a wide range of movie genres from serious dramas to musicals and comedies, and offers an optimum 3D feeling, reproducing effects tones and background music softly but cubically around clear words.
Game	This program is suitable for role-playing and adventure games. It utilizes the sound field effects for movies to represent the depth and spatial feeling of the field during play, while offering movie-like surround effects in the movie scenes in the game.

Playback without using CINEMA DSP (press the OFF key)

DSP Off	Audio content is played in 3D surring mode or surround mode when CINEMA DSP is not used.
----------------	--

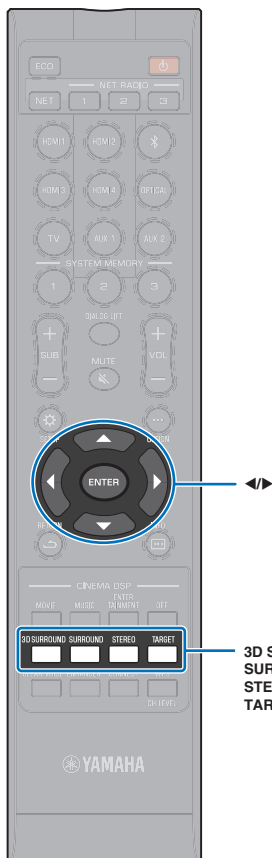

3D SURROUND
SURROUND
STEREO
TARGET

2-channel playback (stereo playback mode)

2-channel stereo playback using the right front and left front channels is enabled. When multi-channel audio signals are input, they are down-mixed to 2 channels.

- 1 Press the **STEREO** key to switch to stereo playback mode.

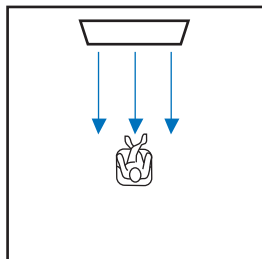

Delivering sound to a specified location (target playback mode)

Target playback mode outputs sound beams from a single channel for optimal listening from a specific position.

Refer to the illustrations below.

For listening at low volumes, such as at night

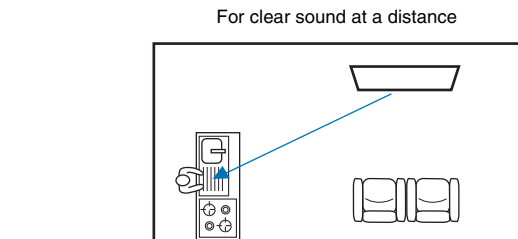
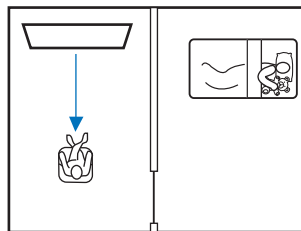

Play an input source, and adjust the beam angle.

- 1 Press the **TARGET** key.
- 2 Use the **◀▶** key to adjust beam angle.

The angle to the left increases by 2 degrees each time the **◀** key is pressed; the angle to the right increases by 2 degrees each time the **▶** key is pressed.

A maximum angle of 90 degrees in either direction is possible.

Beam angle adjusted 16 degrees to the left

TARGET L16

Disabling target playback mode

Press the 3D SURROUND key, SURROUND key, or STEREO key to turn target playback mode off.



- The CINEMA DSP programs are not enabled in target playback mode.
- Bass output is controlled to prevent sounds from spreading in other directions.

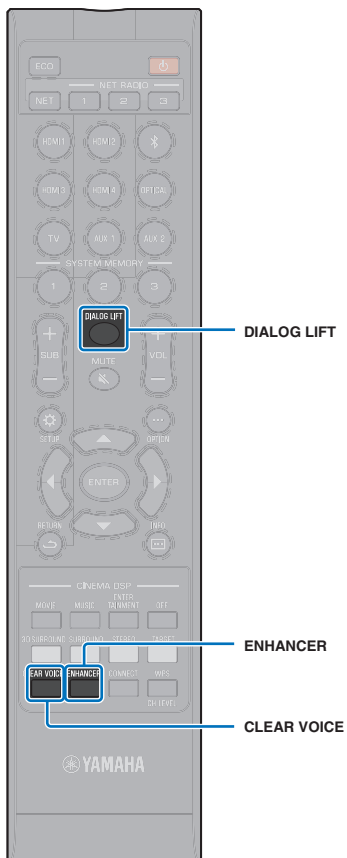

Playing back digitally compressed formats (such as MP3, etc.) with enriched sound (Compressed Music Enhancer)

Play back digitally compressed formats such as MP3, with emphasis on bass and treble for extended dynamic sounds.

1 Press the ENHANCER key to turn on the Compressed Music Enhancer function.

Press the key again to turn off the function.



- Compressed Music Enhancer is disabled when digital audio signal with a sampling rate greater than 48 kHz is input.
- By default, this function is set to "ON" when the input source is *Bluetooth*. It is set to "OFF" with any other input source.
- This unit automatically memorizes the "ON" and "OFF" settings assigned to each input source. When you select another input, the unit automatically recalls the last settings for the selected input.

Clear playback of human voices (CLEAR VOICE)

Human voices, such as lines in movies and TV shows, or news and sports commentary, are played back very clearly.

1 Press the CLEAR VOICE key to turn on the CLEAR VOICE function.

Press the key again to turn off the function.

Adjusting the position from which dialog is heard (Dialog Lift)

When dialog sounds like it is coming from below the TV screen, adjust the position upward so that it sounds as if it is coming from the center of the TV screen.

1 Press the DIALOG LIFT key.

The current setting is displayed.

Dlg. Lift 0

Display changes as follows each time the DIALOG LIFT key is pressed.

0 (default) → 1 → 2 → 3 → 0...

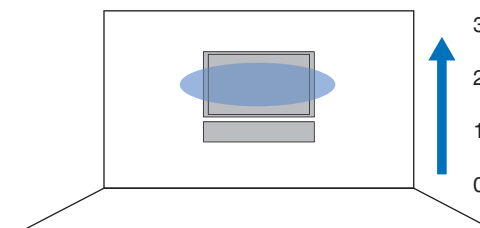

- The dialog lift function can be used with 3D surround sound playback and surround sound playback (other than My Surround playback).

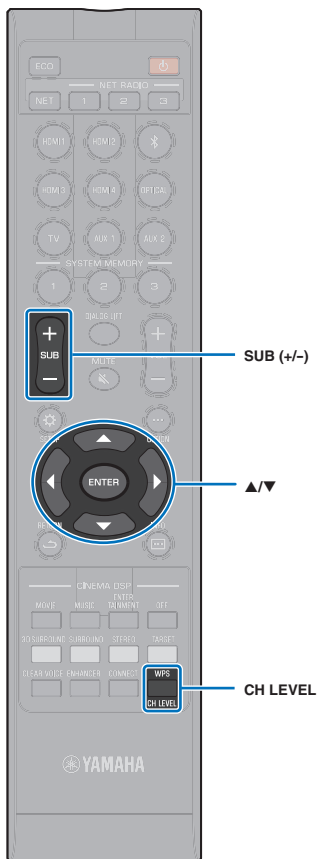

Adjusting volume for each channel

Adjust the volume of playback for each channel (audio in each direction) so that sounds are evenly distributed in their respective directions.



- Refer to “Channel Level” (p. 74) when adjusting the volume of each channel with the test sound.

1 Press the CH LEVEL key to select adjustable channel from the followings.

FL: Front left
 FR: Front right
 C: Center
 SL: Surround left
 SR: Surround right
 HL: Height left
 HR: Height right
 SW: Subwoofer

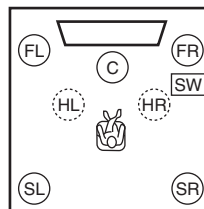

- Adjusting the channel level is not available in target playback mode.
- SW (subwoofer) volume can only be adjusted in stereo playback mode (p. 40).
- Volume for the following channels can be adjusted when “My Surround” is set to “On” (p. 73).
 C: Center
 SL/SR: Surround (left/right)
 SW: Subwoofer

2 Press the ▲/▼ key to adjust the volume.

Adjustable range: -20 to +20



Example of volume balance

- If you have problems hearing words: Select C (center) to increase the level. When the sound is not like surround sound: Select SL (surround left), SR (surround right), HL (height left) or HR (height right) to increase the level.
- The volume of the subwoofer also can be adjusted by using the SUB (+/-) key.

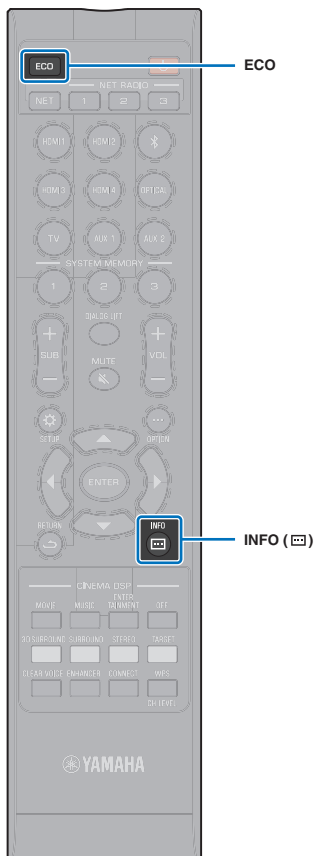

Using useful features

Saving energy with the Eco function

Using the Eco function to reduce the amount of power consumed by this unit.

When this function is enabled, the brightness of the front panel display is minimized and the maximum volume is reduced.

1 Press the ECO key.

“ECO ON” is displayed and the front panel display turns off.

The brightness of STATUS indicator is minimized.

Disabling the Eco function

Press the ECO key.

“ECO OFF” is displayed in the front panel display.



- Disable this function for louder playback.
- When this function is enabled, “Dimmer” in the setup menu (p. 77) and “MAX VOLUME” in the advanced setup menu (p. 86) cannot be configured.

Switching information displayed in the front panel display

Information regarding the input source, surround sound, and subwoofer is displayed.

1 Press the INFO (INFO) key.

Display changes as follows each time the INFO (INFO) key is pressed. The information varies according to the input source.

Input: Name of the input source
 (“BLUETOOTH”, or the name of the connected device, is displayed with *Bluetooth* input.)

↓
 Beam: Playback mode

↓
 Decoder: Current decoder (p. 75)

↓
 Cinema DSP: CINEMA DSP program (p. 38)

↓
 SUB Status: Subwoofer status



- Display in playback mode (Beam)
 - 3D SUR.: Playback in 3D surround mode (p. 37)
 - SURROUND: Playback in surround mode (p. 38)
 - MY SUR.: Playback using the My Surround function (p. 73)
 - STEREO: Stereo playback (p. 40)
 - TARGET: Playback in target playback mode (p. 40)
- Subwoofer status display (SUB Status)
 - Wireless: The unit is connected to the wireless subwoofer kit (p. 25).
 - None: No subwoofer is connected to the unit.
 - Wired: When “Bass Out” in the setup menu is set to “Wired” (p. 73).

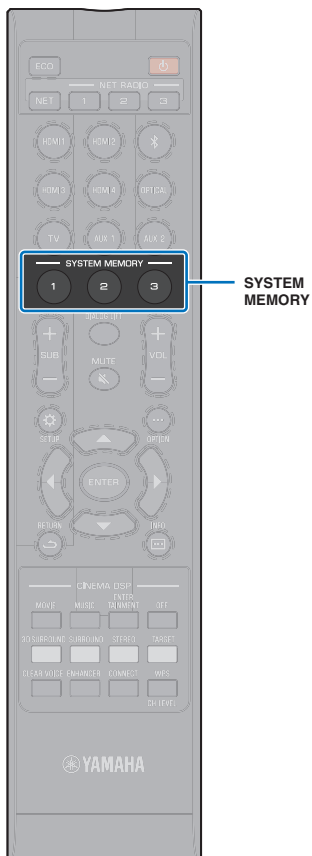

Saving this unit's settings to system memory

Three sets of settings can be saved to this unit's memory, enabling quick loading of settings optimized for specific listeners or environmental changes as needed. Refer to the examples below to save IntelliBeam measurement results and settings such as surround setting to system memory, or to load a pre-defined settings.

Example 1 Saving the IntelliBeam measurements for different environments to system memory

If materials that absorb sound, such as curtains, obstruct sound beams, the effectiveness of those beams decreases. Measure with the curtains open and again with them closed. Save both sets of settings to SYSTEM MEMORY 1 and 2, and load the appropriate settings as needed.

Example 2 Saving frequently used settings to system memory

SYSTEM MEMORY 1: Surround setting

SYSTEM MEMORY 2: A target playback mode setting that projects sound beams toward the kitchen

SYSTEM MEMORY 3: A target playback mode setting that projects sound beams toward the living room

Example 3 Saving preferred listener settings to system memory

SYSTEM MEMORY 1: Settings configured for Dad

SYSTEM MEMORY 2: Settings configured for Mom

SYSTEM MEMORY 3: Settings configured for parties

The following settings can be saved to system memory.

- IntelliBeam measurement results (p. 30)

See page 32 for instructions on saving measurement results for IntelliBeam.

(When "Horizontal Angle", "Vertical Angle", "Beam Travel Length", "Focal Length", "Image Location", and "Channel Level" are configured in the setup menu (p. 66), these settings are applied to IntelliBeam's AUTO SETUP measurements.)

- 3D surround playback (p. 37), surround playback (p. 38), stereo playback (p. 40), or target playback mode (p. 48)
(The Channel Out settings (p. 72) can also be saved for 3D surround/surround playback mode.)
- Surround: CINEMA DSP 3D/CINEMA DSP (p. 38)
- Tone control (p. 84)
- Subwoofer settings (p. 73)

Saving settings to system memory

1 Hold down the SYSTEM MEMORY 1, 2, or 3 key until "M1 Save?", "M2 Save?", or "M3 Save?", corresponding to the button pressed, is displayed.

2 Press the same SYSTEM MEMORY key again.

When the SYSTEM MEMORY 1 key is pressed, "M1 Saving" is displayed, and settings are saved.



- If system settings are already stored in the selected memory number, this unit overwrites the old settings.
- The memory function cannot be set when "MEMORY PROTECT" is set to "ON" in the advanced setup menu (p. 85).

Loading settings

1 Press the SYSTEM MEMORY 1, 2, or 3 key corresponding to settings to be loaded.

If the SYSTEM MEMORY 1 key is pressed, "M1 Load?" will be displayed.

2 Press the same SYSTEM MEMORY key again.

When the SYSTEM MEMORY 1 key is pressed, "M1 Loading" is displayed, and settings are loaded.

Wireless playback of audio via *Bluetooth* connection

The unit can be used to receive and play audio from a *Bluetooth* device, and to transmit audio for playback on a *Bluetooth* device.

See documentation supplied with your *Bluetooth* device for more information.

□ Receiving audio from a *Bluetooth* device

Audio from a *Bluetooth* device, such as a mobile device or a digital music player, can be played over a wireless connection.

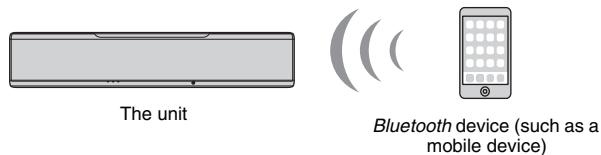

□ Transmitting audio to a *Bluetooth* device

Use *Bluetooth* wireless headphones and the like to listen to audio.

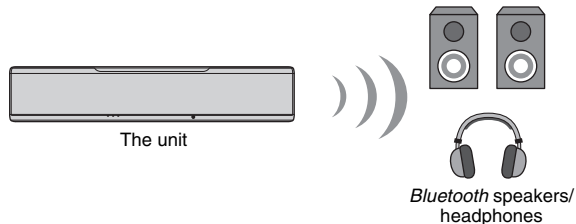

- Audio cannot be received by the unit from mobile devices and the like, and transmitted to speakers or headphones at the same time.



- "Bluetooth" in the setup menu must be set to "On" (default; p. 82) to use *Bluetooth* functions.
- A *Bluetooth* device that has been assigned a passkey (PIN) other than "0000" cannot be connected to the unit.
- The unit can connect to up to 20 *Bluetooth* devices for receiving and transmitting audio. If a new device is successfully connected to the unit after 20 other devices have already been connected, the device information with the earliest connection date (the first device connected) will be erased to make room for the new device.
- Be sure that the *Bluetooth* device is no farther than 10 m (33 ft.) from the unit when connecting the two.
- Refer to "Bluetooth" (p. 94) in "Troubleshooting" if a *Bluetooth* connection cannot be established.
- Adjust *Bluetooth* device volume as needed.



Listening to music from a *Bluetooth* device (Receiving)

1 Press the key on the remote control.

Bluetooth is selected as an input source, and “BLUETOOTH” is shown in the front panel display.

BLUETOOTH



- If a *Bluetooth* device has been connected before, the unit will connect to the last connected device when the  key is pressed. Terminate this connection to connect a new device.
- If you are unable to select *Bluetooth* as an input source, be sure that “Transmission” in the setup menu is set to “Off” (p. 82)

2 Turn on the *Bluetooth* function on the *Bluetooth* device.

The operation varies depending on the device. Refer to documentation supplied with the device.

3 Select “YSP-5600” in the *Bluetooth* device list on the device.

If a passkey (PIN) is required, enter the number “0000”.

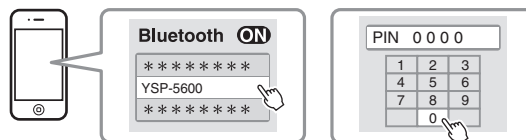

The  indicator in the front panel display flashes while the unit and *Bluetooth* device are being connected, and glows steadily when the connection is established.



Flashes while processing a connection

Glow when the connection is established

“Connect” is shown in the front panel display.

The  indicator or a completion message is displayed on the *Bluetooth* device.

4 Play back a song on the *Bluetooth* device.

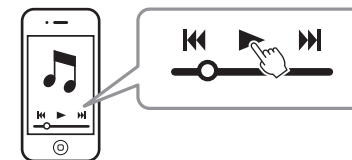

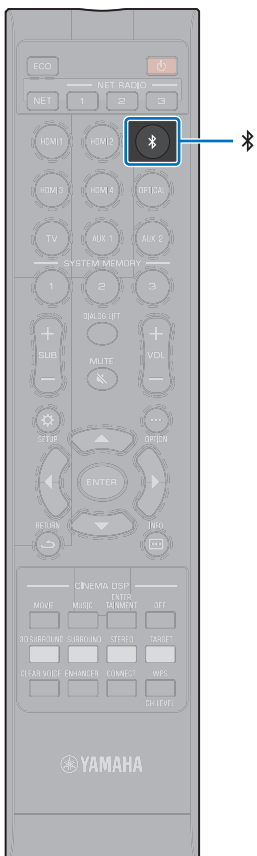

- With some *Bluetooth* devices, this unit must be specified as the destination for audio output.
- Setting “Network Standby” in the setup menu to “On” allows the unit to be turned on and off with *Bluetooth* device operations (p. 81).



Terminating *Bluetooth* connection

Bluetooth connection is terminated in the following cases.

The  indicator on the unit's front panel turns off when the connection is terminated.

- The *Bluetooth* function is turned off on the *Bluetooth* device.
- The  key is pressed for more than 3 seconds.
- The unit is turned off.



- When *Bluetooth* connection is terminated, "Disconnected" is shown in the front panel display.

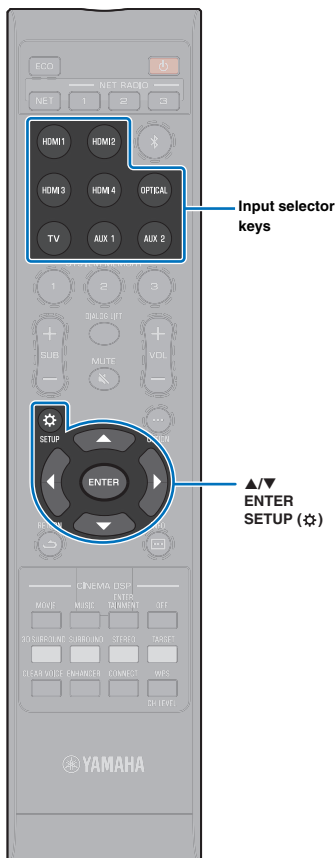

Listening to audio through *Bluetooth* speakers or headphones (transmitting)



- Music input using AirPlay cannot be output to *Bluetooth* devices.

- 1 Turn on the *Bluetooth* device.
- 2 Select the input source (other than *Bluetooth*) with the input selector keys.



- If a *Bluetooth* device has been connected before, the unit will connect to the last connected device when the input source is selected in step 2. Terminate this connection to connect a new device.

- 3 Press the SETUP (⚙️) key twice.
The setup menu is displayed on the TV screen.
- 4 Use the ▲/▼ keys to select “Bluetooth”, and then press the ENTER key.
- 5 Use the ▲/▼ keys to select “Transmission”, and then press the ENTER key.
- 6 Use the ▲/▼ keys to select “On”, and then press the ENTER key.
- 7 Use the ▲/▼ keys to select “Device Search”, and then press the ENTER key.
- 8 Use the ▲/▼ keys to select a *Bluetooth* device, and then press the ENTER key.

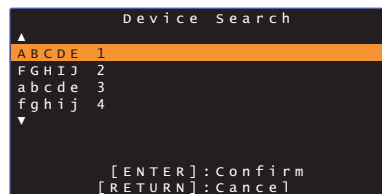

The  indicator in the front panel display flashes while the unit and *Bluetooth* device are being connected, and glows steadily when the connection is established.



“Completed” is shown in the front panel display.

- 9 Play an audio source, and enjoy music via the *Bluetooth* device.



- “Not found” is displayed on the screen with step 8 if the unit was unable to find a device to which to connect.
- “No Device Name” replaces the device name on the screen with step 8 if the unit is unable to recognize the name of the device.
- Audio will also be output from the unit.

Terminating *Bluetooth* connection

Bluetooth connection is terminated in the following cases.

The  indicator on the unit’s front panel turns off when the connection is terminated.

- The connection is terminated from the *Bluetooth* device, or the *Bluetooth* device is turned off.
- “Transmission” in the setup menu is set to “Off”.
- The unit is turned off.



NETWORKS

Network functions

Network connection allows you to listen to Internet radio stations or music streaming services, and play music files with AirPlay or your computer (media service) via this unit.

Depending upon the input source, the mobile app, MusicCast CONTROLLER, may be required. Playback that requires the MusicCast CONTROLLER is indicated with the  icon.

- **Playing music files stored on media servers or mobile devices**

-  PC or DNLA-compatible NAS p. 60
- AirPlay p. 63
-  Mobile devices p. 65

-  **Listening to Internet radio** p. 61

Internet radio stations can be selected once they are registered with the unit.

-  **Transmit and receive audio to/from other MusicCast-enabled devices connected to your home network.**

Refer to the supplied "MusicCast Setup Guide" for details.



- See our website for more information on the MusicCast CONTROLLER app.
- The input source switches automatically when music is played over a network. Use the NET key to switch to a different input source. The input source changes as follows each time the NET key is pressed.

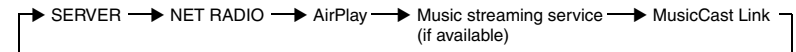

Connecting to a network

You can choose between wired network connection and wireless network connection depending upon your network environment.



- Some security software installed on your computer, or network device settings (such as a firewall), may block the unit's access to your computer or Internet radio stations. Should this occur, change security software and/or network device settings.
- A network connection cannot be established if the MAC address filter on your router is enabled. Check your router's settings.
- To configure your router's subnet mask manually, apply the same subnet used by this unit to all devices.
- Use of a broadband connection is recommended when using Internet services.



- If your router supports DHCP, network settings for the unit need not be configured. Network parameters (such as the IP address) will be assigned automatically. If your router does not support DHCP, or if you prefer to configure network parameters manually, you must configure network settings yourself (p. 80).
- You can verify that network parameters (such as the IP address) have been properly assigned to the unit by selecting "Information" (p. 78) from the setup menu.

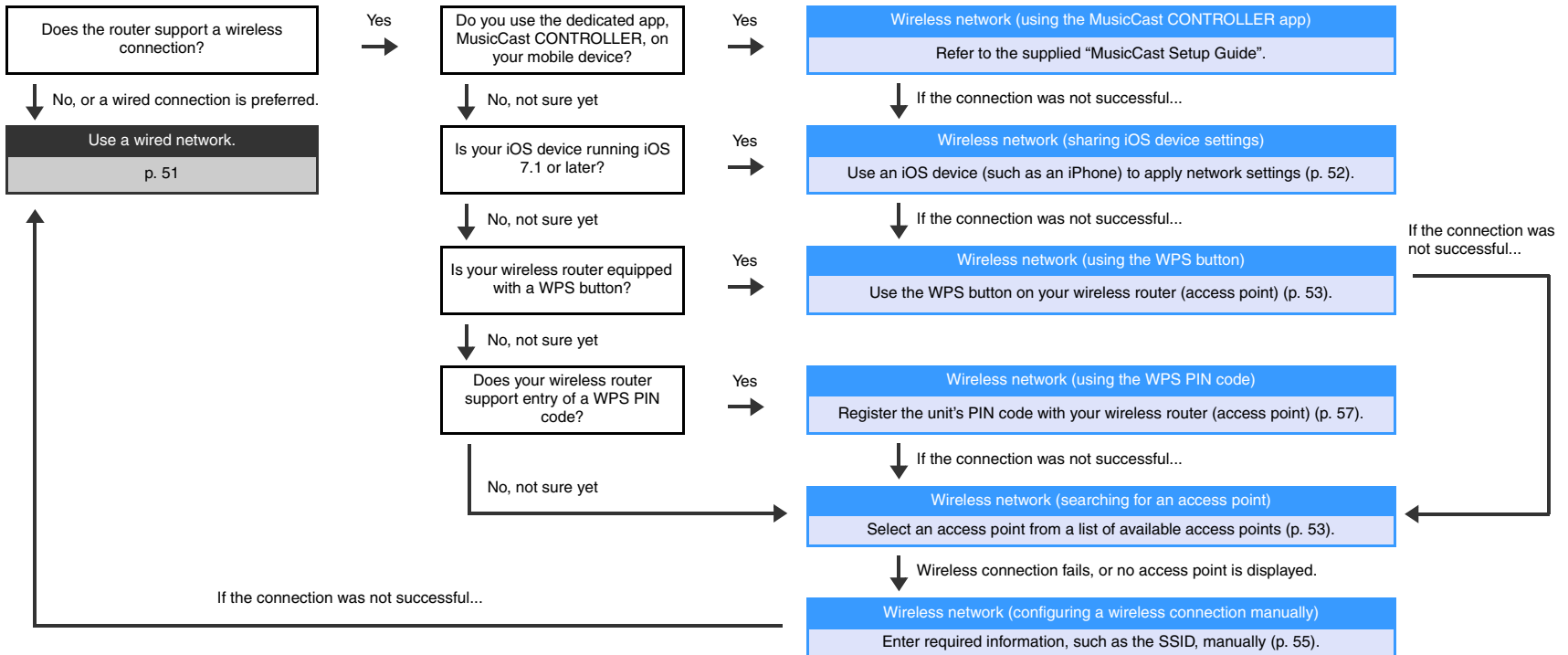

Wired network connections

To use a wired network connection, connect the unit to a router via an STP network cable (category 5 or higher straight cable; not supplied).

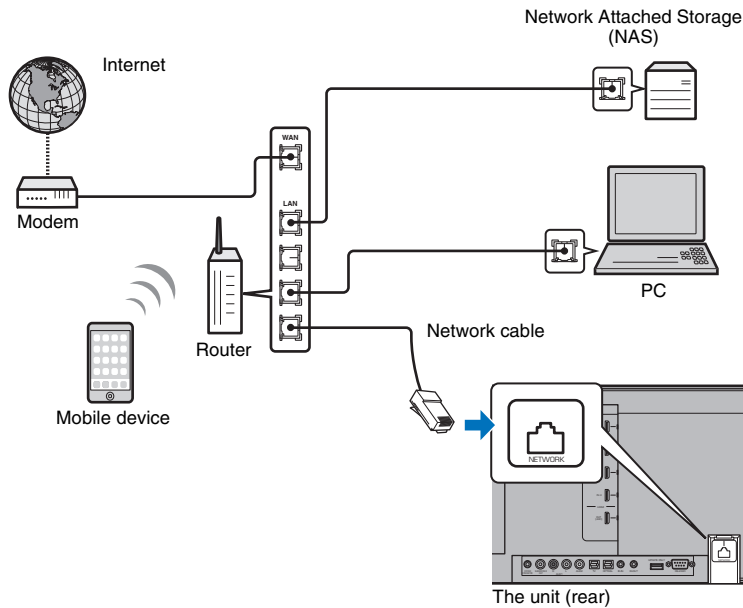

- If the unit is already connected to a wireless network and you would like to switch to a wired connection, change "Network" in the setup menu to "Wired".

Wireless network

Connect the unit to a wireless router (access point).

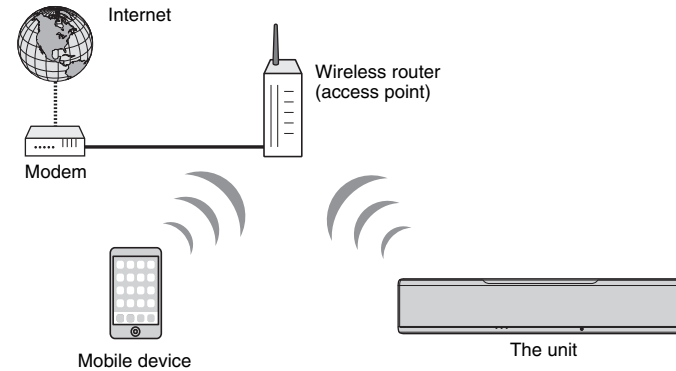

The  indicator on the front panel glows when the unit is connected to a wireless network.



- You cannot use the wireless network connection simultaneously with the wired network connection (p. 51) or Wireless Direct (p. 58).
- If the unit and the wireless router (access point) are too far apart, the unit may not connect to a wireless router (access point). In such case, place them close to each other.



- If the unit will not be connected to a wireless router (access point), Wireless Direct (p. 58) can be used to connect the unit directly to a mobile device to control the unit using the HOME THEATER CONTROLLER (WLAN) app installed on that mobile device.

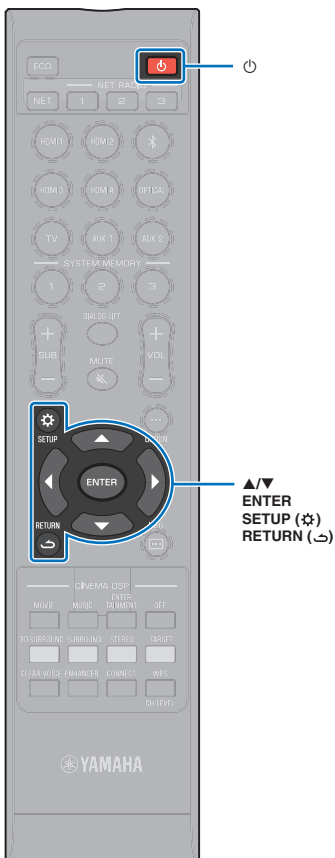

Sharing the iOS device setting

You can easily setup a wireless connection by applying the connection settings on iOS devices (such as an iPhone).

Before proceeding, confirm that your iOS device is connected to a wireless router (access point).



- You need iOS device with iOS 7.1 or later.
- The connection settings on iOS devices cannot be applied to the unit to establish a wireless connection if your wireless router (access point) uses WEP encryption. See “Searching for a wireless router (access point)” (p. 53) to establish a connection.

- 1 Press the key to turn on this unit.
- 2 Turn on the TV and switch the TV input to display video from the unit (HDMI OUT jack; p. 27).
- 3 Press the SETUP (⚙️) key twice.
The setup menu is displayed on the TV screen.
- 4 Use the ▲/▼ keys to select “Network”, and then press the ENTER key.
- 5 Use the ▲/▼ keys to select “Network Connection”, and then press the ENTER key.
- 6 Use the ▲/▼ keys to select “Wireless (Wi-Fi)”, and then press the ENTER key.

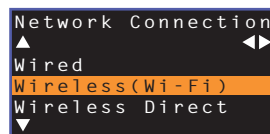

- 7 Use the ▲/▼ keys to select “Share Wi-Fi Settings (iOS)”, and then press the ENTER key.

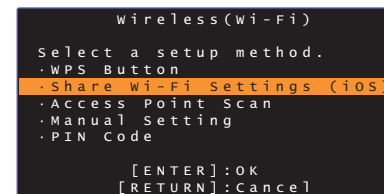

- 8 When the following screen is displayed, press the ENTER key.

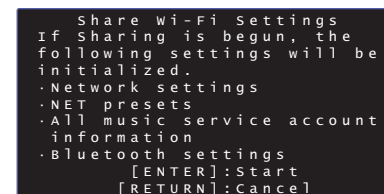

- The settings to be deleted (initialized) will be displayed. If you do not want to delete these settings, press the RETURN (←) key to terminate the connection.

- 9 When the following screen is displayed, press the ENTER key.

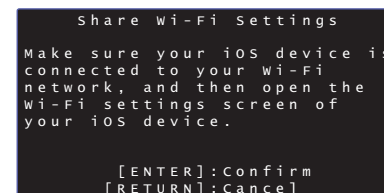

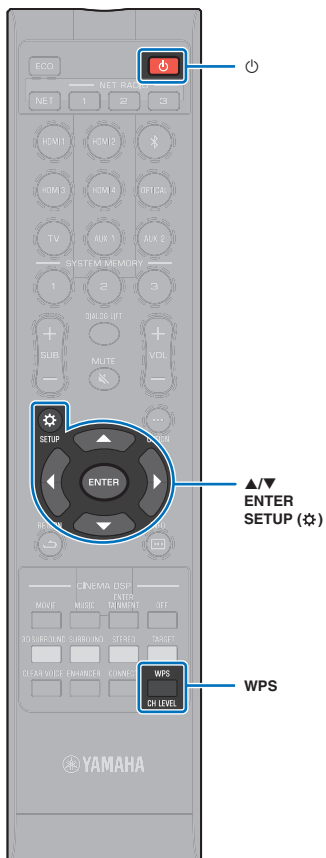

10 Display the Wi-Fi setup screen on the iOS device and select the unit from “SETUP A NEW AIRPLAY SPEAKER...”.

Follow the on-screen instructions displayed on the iOS device.

Using the WPS push button configuration

You can easily set up a wireless connection with one push of the WPS button on the wireless router (access point).

- 1 Press the ⏻ key to turn on this unit.
- 2 Press and hold the WPS key on the remote control for at least 3 seconds.
“Press WPS button on Access Point” will be displayed in the front panel display.



• To cancel configuration, press any key other than the WPS key.

3 Push the WPS button on the wireless router (access point).

When a connection has been established, “Completed” will be displayed in the front panel display.

If “NotConnect” is displayed, repeat the procedure from step 1 again, or see the information below to try another connection method.



- The WPS button cannot be used to establish a wireless connection if your wireless router (access point) uses WEP encryption, or if the router’s MAC address filter is enabled. See “Searching for a wireless router (access point)” (p. 53) to establish a connection.
- The WPS button cannot be used to establish a wireless connection if your wireless router (access point) is configured so that it does not broadcast its SSID. See “Setting up the wireless connection manually” (p. 55) to establish a connection.



- “WPS Button” under “Wireless (Wi-Fi)” in the setup menu can also be used to configure a connection using the WPS button. Follow the on-screen instructions.

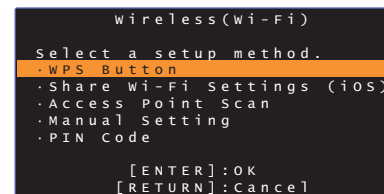

About WPS

WPS (Wi-Fi Protected Setup) is a standard established by the Wi-Fi Alliance, which allows easy establishment of a wireless home network.

Searching for a wireless router (access point)

Find and connect to a nearby wireless router (access point).

- 1 Press the ⏻ key to turn on this unit.
- 2 Turn on the TV and switch the TV input to display video from the unit (HDMI OUT jack; p. 27).
- 3 Press the SETUP (⚙️) key twice.
The setup menu is displayed on the TV screen.
- 4 Use the ▲/▼ keys to select “Network”, and then press the ENTER key.
- 5 Use the ▲/▼ keys to select “Network Connection”, and then press the ENTER key.



ENTER SETUP (⚙️)

- Use the ▲/▼ keys to select “Wireless (Wi-Fi)”, and then press the ENTER key.

```

Network Connection
▲
Wired
Wireless (Wi-Fi)
▼
Wireless Direct
  
```

- Use the ▲/▼ keys to select “Access Point Scan”, and then press the ENTER key.

```

Wireless (Wi-Fi)
Select a setup method.
· WPS Button
· Share Wi-Fi Settings (iOS)
· Access Point Scan
· Manual Setting
· PIN Code

[ENTER]: OK
[RETURN]: Cancel
  
```

The list of available access points appears on the TV screen.

- Use the ▲/▼ keys to select the desired access point and press the ENTER key.

The wireless connection setting screen appears on the TV.

```

Access Point Scan
▲
SSID : Access Point 1
Security: WPA2-PSK(AES)
Security Key
Connect
▼

[ENTER]: Confirm
[RETURN]: Cancel
  
```

- Press the ENTER key.

- Use the ◀/▶/▲/▼ and ENTER keys to enter the security key.

```

*****
( ) [ ] { } < > * ! ? ^ # % &
. : ; _ | / \ $ ~ ~ @ + - =
0 1 2 3 4 5 6 7 8 9
A B C D E F G H I J K L M
N O P Q R S T U V W X Y Z
a b c d e f g h i j k l m
n o p q r s t u v w x y z
Space BKSP DELETE CLEAR
OK
CANCEL
  
```

[←]/[→]: Move the cursor left and right.
 [Space]: Enter a space.
 [BKSP]: Delete the character to the left of the selected one.
 [DELETE]: Delete the selected character.
 [CLEAR]: Delete all characters entered.
 [CANCEL]: Cancel character entry, and return to the previous screen.

Once the security key been entered, select “OK”, and then press the ENTER key. The screen will return to that displayed in step 8.

- Use the ▲/▼ keys to select “Connect” and press the ENTER key to start the connection process.

When a connection has been established, “Completed” will be displayed on the TV screen.

If “Not connected” is displayed press the ENTER key to repeat the process beginning with step 6, or see the information below to try another connection method.



- “Access Point Scan” cannot be used to establish a wireless connection if your wireless router (access point) is configured so that it does not broadcast its SSID. See “Setting up the wireless connection manually” (p. 55) to establish a connection.

- Press the SETUP (⚙️) key to exit the setup menu.

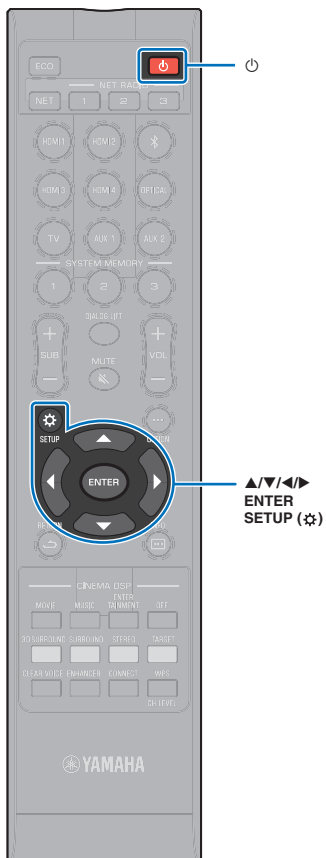

Setting up the wireless connection manually

Setup the SSID (network name), encryption method and security key for your network manually.

- 1 Press the key to turn on this unit.
- 2 Turn on the TV and switch the TV input to display video from the unit (HDMI OUT jack; p. 27).
- 3 Press the SETUP (☆) key twice.
The setup menu is displayed on the TV screen.
- 4 Use the ▲/▼ keys to select “Network”, and then press the ENTER key.
- 5 Use the ▲/▼ keys to select “Network Connection”, and then press the ENTER key.
- 6 Use the ▲/▼ keys to select “Wireless (Wi-Fi)”, and then press the ENTER key.

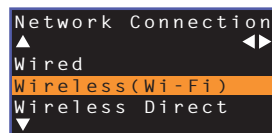

- 7 Use the ▲/▼ keys to select “Manual Setting”, and then press the ENTER key.

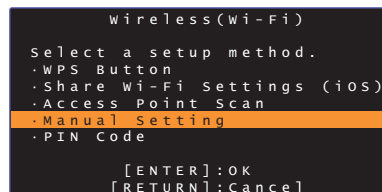

- 8 Use the ▲/▼ keys to select “SSID”.

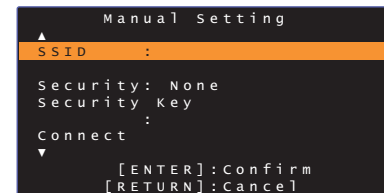

- 9 Use the ◀/▶/▲/▼ keys and the ENTER key to enter the SSID of the access point.

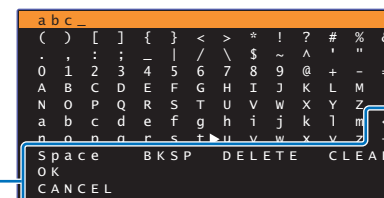

- [←]/[→]: Move the cursor left and right.
- [Space]: Enter a space.
- [BKSP]: Delete the character to the left of the selected one.
- [DELETE]: Delete the selected character.
- [CLEAR]: Delete all characters entered.
- [CANCEL]: Cancel character entry, and return to the previous screen.

Once the security key been entered, select “OK”, and then press the ENTER key. The screen will return to that displayed in step 8.

- 10 Use the ▲/▼ keys to select “Security” and the ◀/▶ keys to select the encryption method.

Settings

None, WEP, WPA2-PSK (AES), Mixed Mode



- As communications are not encrypted when “None” is selected, selecting this option poses the risk that third parties may access the unit without your permission.



▲/▼/◀/▶
ENTER
SETUP (⚙️)

11 Use the ▲/▼ keys to select “Security Key” and press the ENTER key.



- If you select “None” in step 10, this item is not available.

12 Use the ◀/▶/▲/▼ and ENTER keys to enter the security key.

If you select “WEP” in step 10, enter either 5 or 13 character string, or 10 or 26 hexadecimal (base 16) keys.

If you select the method other than “WEP”, enter either 8 to 63 character string, or 64 hexadecimal (base 16) keys.



- Hexadecimal (base 16) keys use combinations of the numbers 0 through 9 and the letters a through f. Letters are not case sensitive.

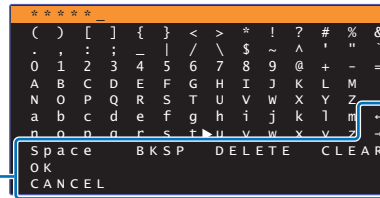

- [←]/[→]: Move the cursor left and right.
- [Space]: Enter a space.
- [BKSP]: Delete the character to the left of the selected one.
- [DELETE]: Delete the selected character.
- [CLEAR]: Delete all characters entered.
- [CANCEL]: Cancel character entry, and return to the previous screen.

Once the security key been entered, select “OK”, and then press the ENTER key. The screen will return to that displayed in step 8.

13 Use the ▲/▼ keys to select “Connect” and press the ENTER key to start the connection process.

When a connection has been established, “Completed” will be displayed on the TV screen.

If “Not connected” is displayed press the ENTER key to repeat the process beginning with step 6.

14 Press the SETUP (⚙️) key to exit the setup menu.

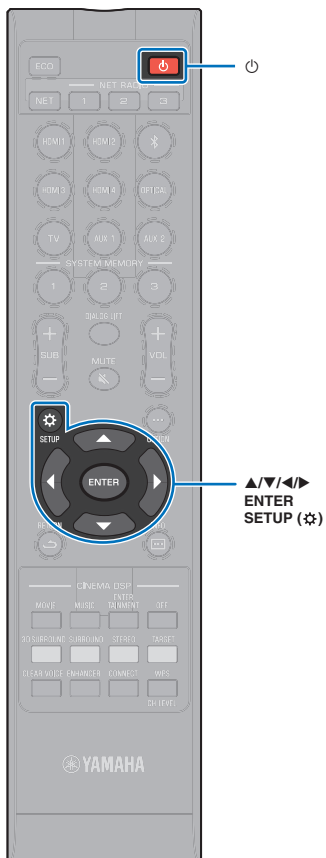

Using the WPS PIN code

Register the unit's PIN code with your wireless router (access point) to establish a connection. This procedure applies if your wireless LAN router (access point) supports the WPS PIN feature.

- 1 Press the key to turn on this unit.
- 2 Turn on the TV and switch the TV input to display video from the unit (HDMI OUT jack; p. 27).
- 3 Press the SETUP (⚙️) key twice.
The setup menu is displayed on the TV screen.
- 4 Use the keys to select "Network", and then press the ENTER key.
- 5 Use the keys to select "Network Connection", and then press the ENTER key.
- 6 Use the keys to select "Wireless (Wi-Fi)", and then press the ENTER key.

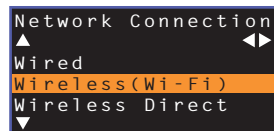

- 7 Use the keys to select "PIN Code", and then press the ENTER key.

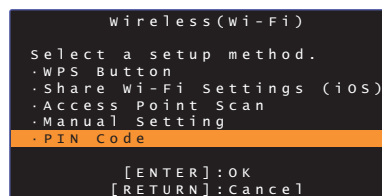

The list of available access points appears on the TV screen.

- 8 Use the keys to select the desired access point and press the ENTER key.

The PIN code of the unit appears on the TV screen.

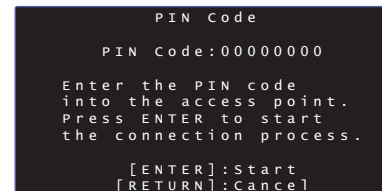

- 9 Enter the unit's PIN code into the wireless router (access point).

For details on settings, refer to documentation supplied with the wireless router (access point).

- 10 Press the ENTER key to start the connection process.

When a connection has been established, "Completed" will be displayed on the TV screen.

If "Not connected" is displayed press the ENTER key to repeat the process beginning with step 6, or see the information below to try another connection method.



- The PIN code cannot be used to establish a wireless connection if your wireless router (access point) uses WEP encryption, or if the router's MAC address filter is enabled. See "Searching for a wireless router (access point)" (p. 53) to establish a connection.

- 11 Press the SETUP (⚙️) key to exit the setup menu.

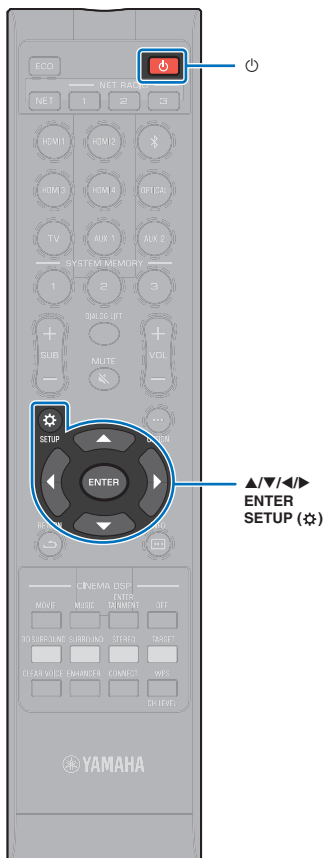

Connecting a mobile device to the unit directly (Wireless Direct)



Connect a mobile device directly to the unit without using a wireless router (access point).

Wireless Direct supports the following.

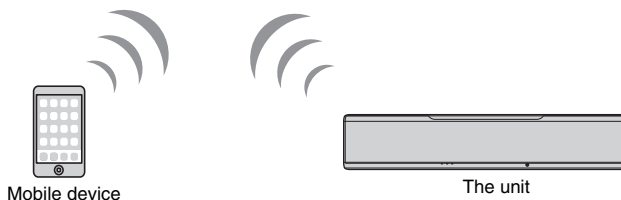





- Operation of the unit using a mobile device to which the dedicated MusicCast CONTROLLER or HOME THEATER CONTROLLER (WLAN) app has been installed.
- Use of AirPlay to play music files stored on an iOS device.







- You cannot use Wireless Direct simultaneously with the wired network connection (p. 51) or the wireless network connection (p. 51).
- When Wireless Direct is enabled, the unit cannot connect to the Internet. Therefore, you cannot use any kind of Internet service such as Internet radio.

- 1 Press the  key to turn on this unit.**
- 2 Turn on the TV and switch the TV input to display video from the unit (HDMI OUT jack; p. 27).**
- 3 Press the SETUP () key twice.**

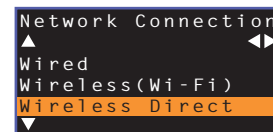
The setup menu is displayed on the TV screen.

- 4 Use the / keys to select “Network”, and then press the ENTER key.**
- 5 Use the / keys to select “Network Connection”, and then press the ENTER key.**
- 6 Use the / keys to select “Wireless Direct”, and then press the ENTER key.**



- 7 Use the / keys to select “Security” and the / keys to select the encryption method.**



Settings

None, WPA2-PSK (AES)

In most cases, “WPA2-PSK (AES)” should be selected. If your mobile device does not support “WPA2-PSK (AES)”, select “None”.



- As communications are not encrypted when “None” is selected, selecting this option poses the risk that third parties may access the unit without your permission.

- 8 Use the / keys to select “Security Key” and press the ENTER key.**



- If you select “None” in step 7, this item is not available.



▲/▼/◀/▶
ENTER
SETUP (⚙️)

9 Use the ◀/▶/▲/▼ and ENTER keys to enter the security key.

Enter either 8 to 63 character string, or 64 hexadecimal (base 16) keys.



- Hexadecimal (base 16) keys use combinations of the numbers 0 through 9 and the letters a through f. Letters are not case sensitive.

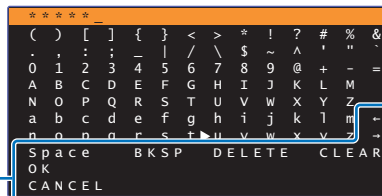

- [←]/[→]: Moves the cursor left and right.
- [Space]: Enter a space.
- [BKSP]: Delete the character to the left of the selected one.
- [DELETE]: Delete the selected character.
- [CLEAR]: Delete all characters entered.
- [CANCEL]: Cancel character entry, and return to the previous screen.

Once the security key been entered, select “OK”, and then press the ENTER key. The screen below will be displayed.

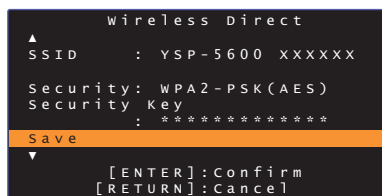

- Before proceeding to the next step, record the following information. These information will be needed to configure the Wi-Fi setting of a mobile device.
 - SSID displayed on the TV screen
 - Security key you have just entered

10 Use the ▲/▼ keys to select “Save” and press the ENTER key to save the setting.

This completes the settings and “Set the mobile device.” will be displayed on the TV screen. The unit functions as an access point.

Next, configure the Wi-Fi settings of a mobile device.

11 Configure the Wi-Fi settings of a mobile device.

For details on settings of your mobile device, refer to documentation supplied with the mobile device.

- Enable the Wi-Fi function on the mobile device.
- Select the SSID displayed in step 9 from the list of available access points.
- When you are prompted for a password, enter the security key displayed in step 9.

12 Press the SETUP (⚙️) key to exit the setup menu.



Playing back music stored on media servers (PCs/NAS)

You can play back music files stored on your PC or DLNA-compatible NAS on the unit.



- To use this function, the unit and your PC must be connected to the same router (p. 50). You can check whether the network parameters (such as the IP address) are properly assigned to the unit in "Information" (p. 78) in the setup menu.
- The audio may be interrupted while using the wireless network connection. In this case, use the wired network connection.



- The following file formats are supported.
 - The unit supports playback of WAV (PCM format only), AIFF, MP3, WMA, MPEG-4 AAC, FLAC and ALAC (Apple Lossless Audio Codec) files (1- or 2-channel audio only).
 - The unit is compatible with sampling rates of up to 192 kHz for WAV, AIFF and FLAC files, 96 kHz for ALAC files, and 48 kHz for other files.
 - The unit supports gapless playback of WAV, FLAC and ALAC files.
 - To play back FLAC files, you need to install server software that supports sharing of FLAC files via DLNA on your PC or use a NAS that supports FLAC files.
 - Digital Rights Management (DRM) contents cannot be played back.

Media sharing setup

To play back music files stored on your PC or DLNA-compatible NAS, first you need to configure the media sharing setting on each music server.

For a PC with Windows Media Player installed

This unit supports Windows Media Player 11 or later. This section explains Windows Media Player 12 setup as an example.

- 1 Start Windows Media Player 12 on your PC.
- 2 Select "Stream", then "Turn on media streaming".
- 3 Click "Turn on media streaming".
- 4 Select "Allowed" from the drop-down list next to the unit's model name.
- 5 Click "OK" to exit.

For a PC or a NAS with other DLNA server software installed

Refer to documentation supplied with the device or software and configure the media sharing settings.

Playing music files

Use the MusicCast CONTROLLER app installed on your mobile device to play music files.



- Configure basic settings for the MusicCast CONTROLLER app before playing music files.
- Refer to the supplied "MusicCast Setup Guide" for details.

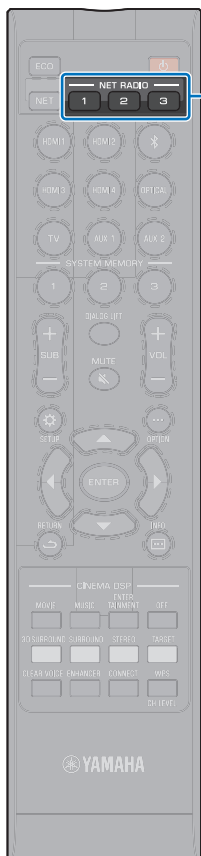

NET RADIO
1-3



Listening to Internet radio

You can listen to Internet radio stations from all over the world.



- To use this function, the unit must be connected to the Internet (p. 50). You can check whether the network parameters (such as the IP address) are properly assigned to the unit in “Information” (p. 78) in the setup menu.
- You may not be able to receive some Internet radio stations.
- The unit uses the vTuner Internet radio station database service. This service may be discontinued without notice.

Playback of Internet radio

Use the MusicCast CONTROLLER app installed on your mobile device to select an Internet radio station.



- Configure basic settings for the MusicCast CONTROLLER app before selecting an Internet radio station.
- Refer to the supplied “MusicCast Setup Guide” for details.

Registering favorite Internet radio stations

Assign Internet radio stations to the NET RADIO keys on the remote control, or save them in the vTuner Bookmarks folder.

Assigning a station to a NET RADIO key

- 1 Select the desired Internet radio station.
- 2 Press and hold one of the NET RADIO keys (1–3) for at least 3 seconds.

Tuning into assigned Internet radio stations

- 1 Press the NET RADIO key (1–3) to which the desired Internet radio station has been assigned.

“NET RADIO” is shown in the front panel display, and streaming begins.

■ Registering the station on the vTuner website

You can also register your favorite Internet radio stations on the vTuner website.

1 Select any of Internet radio stations on the unit.

This operation is necessary to register the radio station for the first time.

2 Check the vTuner ID of the unit.

You can find the vTuner ID in “Information” (p. 78) in the setup menu.

3 Access the vTuner website (<http://yradio.vtuner.com/>) with the web browser on your PC and enter the vTuner ID.

You can switch the language.



Enter the vTuner ID in this area.



- To use this feature, you need to create your personal account. Create your account using your e-mail address.

4 Register your favorite radio stations.

Click the “Add” icon (♥+) next to the station name.



- To remove the station from the “Bookmarks” folder, select “Bookmarks” in the Home screen, and then click the “Remove” icon (♥-) next to the station name.

Playing back music with AirPlay

The AirPlay function allows you to play back iTunes or iPod music on the unit via network.



- This section describes “iPod touch”, “iPhone” and “iPad” as the “iPod”. “iPod” refers to “iPod touch”, “iPhone” and “iPad”, unless otherwise specified.

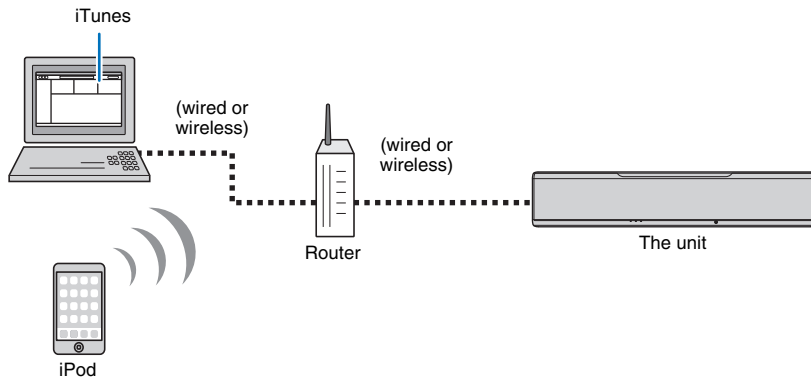

- To use this function, the unit and your PC or iPod must be connected to the same router (p. 50). You can check whether the network parameters (such as the IP address) are properly assigned to the unit in “Information” (p. 78) in the setup menu.
- When using a multiple SSID router, access to the unit might be restricted depending on the SSID to connect. Connect the unit and iPod to the same SSID.
- The AirPlay function can be used with an iPhone, iPad, or iPod touch running iOS 4.3.3 or later, a Mac running OS X version 10.8 “Mountain Lion” or later, or a Windows computer with iTunes 10.2.2 or later installed.

Playback of iTunes/iPod music contents

Follow the procedure below to play back iTunes/iPod music contents on the unit.

1 Turn on the unit, and start iTunes on the PC or display the playback screen on the iPod.

If the iTunes/iPod recognizes the unit, the AirPlay icon () appears.

iTunes (example)

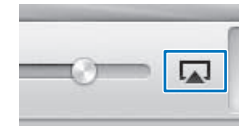

iPod iOS7/iOS8 (example)

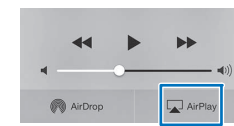

iPod iOS6 (example)

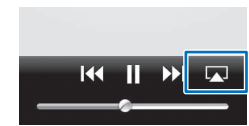

- If the icon does not appear, check whether the unit and PC/iPod are connected to the router properly.

2 On the iTunes/iPod, click (tap) the AirPlay icon and select the unit (network name of the unit) as the audio output device.

iTunes (example)

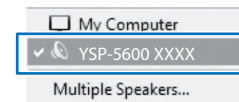

iPod (example)

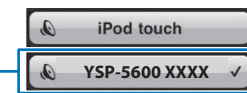

Network name of the unit

3 Select a song and start playback.

To operate playback, use the Music app on the iPod or iTunes on the PC.

“AirPlay” is shown in the front panel display, and playback begins.



- You can turn on the unit automatically when starting playback on iTunes or iPod by setting “Network Standby” (p. 81) in the setup menu to “On”.
- You can edit the network name (the unit’s name on the network) displayed on iTunes/iPod in “Network Name” (p. 81) in the setup menu.
- You can adjust the unit’s volume from the iTunes/iPod during playback.

Caution

- When you use iTunes/iPod controls to adjust volume, the volume may be unexpectedly loud. This could result in damage to the unit or speakers. If the volume suddenly increases during playback, stop playback on the iTunes/iPod immediately.



Playing back music stored on mobile devices

Use this function to play music stored on your mobile device over a network.

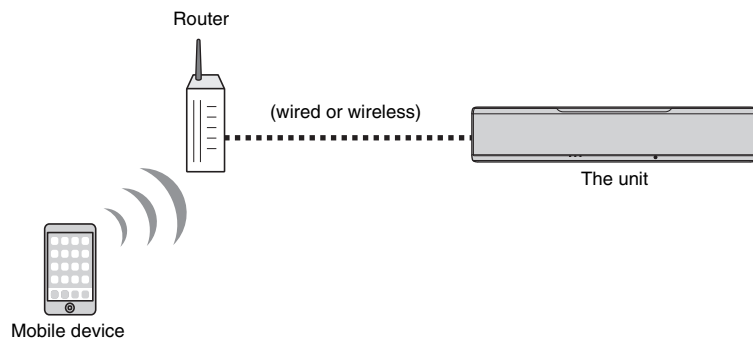

- To use this function, the unit and your PC or mobile device must be connected to the same router (p. 50). You can check whether the network parameters (such as the IP address) are properly assigned to the unit in "Information" (p. 78) in the setup menu.
- When using a multiple SSID router, access to the unit might be restricted depending on the SSID to connect. Connect the unit and mobile device to the same SSID.

Using a mobile device to play songs

Use the MusicCast CONTROLLER app installed on your mobile device to operate playback.



- Configure basic settings for the MusicCast CONTROLLER app before playing music.
- Refer to the supplied "MusicCast Setup Guide" for details.

Caution

- When you use mobile device controls to adjust volume, the volume may be unexpectedly loud. This could result in damage to the unit or speakers. If the volume suddenly increases during playback, stop playback on the mobile device immediately.

SETTINGS

Setup menu

A variety of settings for this unit can be specified and adjusted from the setup menu. Among the options available are the sound beam output method for optimal surround sound effects, channel volume control, and HDMI settings.

The setup menu is displayed on, and operated from, the TV screen (it cannot be displayed in the front panel display). See “Displaying the menu screen on the TV” (p. 27) for instructions on displaying the setup menu on the TV.

Setting the setup menu

1 Press the SETUP (⚙) key.

The menu changes as follows each time the SETUP (⚙) key is pressed.

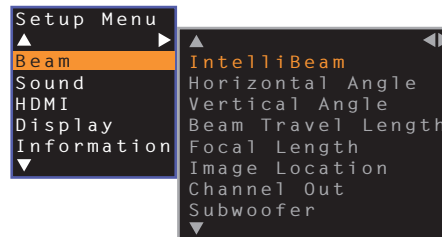
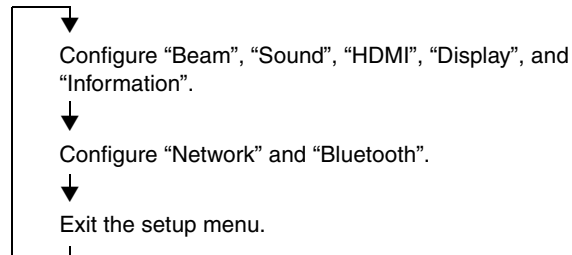

2 Press the ▲/▼ key to select a menu and then press the ENTER key or ► key.

Repeat these steps to display the desired menu.

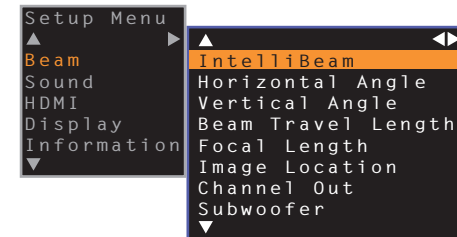

Press the ◀ key or RETURN (↵) key to return to the previous menu.

3 Press the ▲/▼ key to change the setting value of each menu.

4 Press the SETUP (⚙) key again to exit the setup menu.



- Hold down the SETUP (⚙) key to display “OSD Language” directly on the screen (p. 28, 77).
- If an update for the unit’s firmware is available, an envelope icon (✉) will be displayed in the setup menu (p. 87).

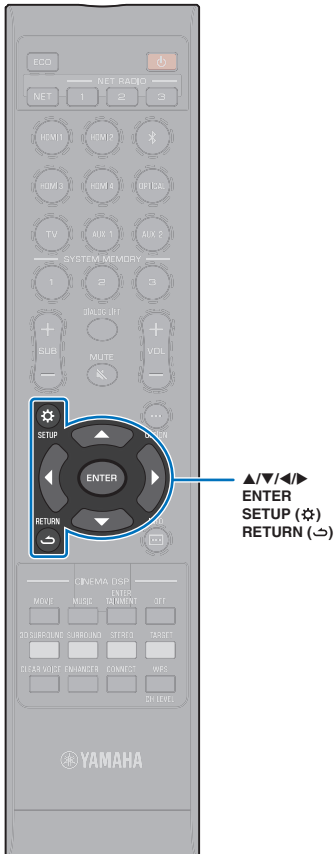

Setup menu list

Menu	Settings	Function	Page	
Beam	IntelliBeam	Beam+Sound optimize	Optimizes the sound beam and sound settings automatically.	32
		Beam optimize only	Optimizes the sound beam settings automatically.	32
		Sound optimize only	Optimizes the sound settings automatically.	32
	Horizontal Angle	Front L, Front R, Center, Surround L, Surround R	Adjust horizontal sound beam angle.	69
	Vertical Angle	Front L, Front R, Center, Surround L, Surround R, Height L, Height R	Adjust vertical sound beam angle.	69
	Beam Travel Length	Front L, Front R, Center, Surround L, Surround R, Height L, Height R	Adjust sound beam travel length.	70
	Focal Length	Front L, Front R, Center, Surround L, Surround R, Height L, Height R	Adjust sound beam focal length.	70
	Image Location	Adjustment, Left, Right	Adjusts the sound position of the front right and left channels.	71
	Channel Out	Front	Specify the output method for the front channels.	72
		Surround Back	Specify whether or not there are surround back channels.	72
		My Surround	Enable/disable the My Surround function.	73
	Subwoofer	Bass Out	Specify whether or not the subwoofer is used and how it is connected.	73
		Cross Over	Specify the upper limit of audio frequencies output from the subwoofer.	73
		Distance	Specify the distance from the subwoofer to the listening position.	73
Pairing		Manually pair the unit with the wireless subwoofer kit.	73	
Sound	Channel Level	Front L, Front R, Center, Surround L, Surround R, Height L, Height R, Subwoofer	Adjusts the volume of each channel.	74
	Adaptive DRC		Choose whether or not dynamic range is adjusted based on this unit's volume level.	74
	Dynamic Range		Specify dynamic range.	75
	DTS	Neural:X, Dialog Control	Specify the DTS decoder.	75
HDMI	HDMI Control		Turn HDMI control on or off.	76
	HDMI Audio Out		Choose whether HDMI audio input is played via this unit or the TV.	76
	TV Input		Select the TV input jack from TV (digital optical) jack, AUX1 (analog) jack, and AUX2 (digital coaxial) jack.	76

Menu	Settings	Function	Page	
Display	Dimmer	Adjust the brightness of the front panel display and indicators.	77	
	OSD Language	Changes the language used for menus displayed on the TV screen.	77	
	Distance Unit	Specify units used for length and distance in menus.	77	
Information	Audio	Display audio input signal information.	78	
	Video	Display video input signal information.	78	
	System	Display this unit's firmware version.	78	
Network	Information	Display the unit's network information.	79	
	Network Connection	Select the network connection method.	79	
	IP Address	DHCP, IP Address, Subnet Mask, Default Gateway, DNS Server (P), DNS Server (S)	Configure the network parameters (such as IP address).	80
	MAC Address Filter	Filter, MAC Address 1–10	Set the MAC address filter to limit access to the unit from other network devices.	80
	Network Standby		Enable/disable the function that turns on the unit from other network devices.	81
	Network Name		Edit the network name (the unit's name on the network) displayed on other network devices.	81
	Network Update	Perform Update	Update the firmware via the network.	81
Bluetooth	Bluetooth	Enable/disable the <i>Bluetooth</i> functions.	82	
	Transmission	Turn the function that transmits audio to a <i>Bluetooth</i> device, such as <i>Bluetooth</i> speakers, on or off.	82	
	Device Search	Search for the <i>Bluetooth</i> device, such as <i>Bluetooth</i> speakers, to which audio will be transmitted.	82	
	MAC Address	Display the MAC address for the <i>Bluetooth</i> connection.	82	

Beam

When "AUTO SETUP" in the "IntelliBeam" menu (p. 30) is used, recommended beam settings are automatically applied by this unit. However, "Horizontal Angle", "Vertical Angle", "Beam Travel Length", "Focal Length" (except "Center"), and "Image Location" settings can later be fine-tuned. The output method for each channel can also be specified in "Beam" menu.



• When manually adjusting sound beams for the front channels, set "Front" for "Channel Out" to "Beam". Adjustment is not possible if "Front" is set to "Stereo".

Horizontal Angle



Adjust the horizontal angle of sound beams for each channel using test tones. Adjust toward L (left) to move the direction of the output to the left and adjust toward R (right) to move it to the right.

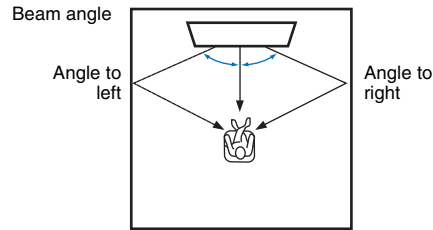

Settings

Front L, Front R, Center, Surround L, Surround R

Adjustable range

L90° to R90°

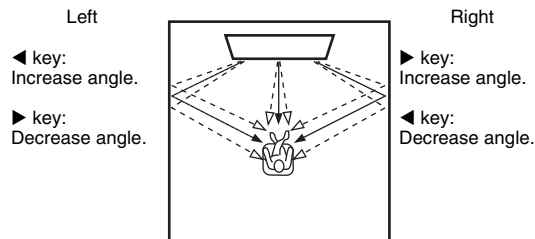

Vertical Angle



Adjust the vertical angle of sound beams for each channel using test tones. Adjust upward to move output direction up, and adjust downward to move output direction down.

Settings

Front L, Front R, Center, Surround L, Surround R

Adjustable range

-45° to +45° (default: 0° (horizontal))

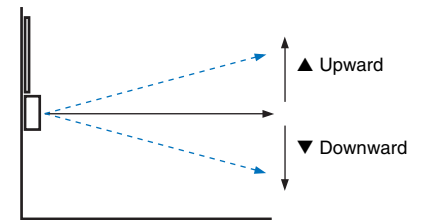

Settings

Height L, Height R

Adjustable range

+30° to +90°

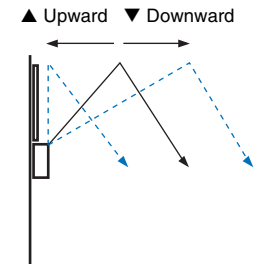

Beam Travel Length

Setup Menu



Beam



Beam Travel Length

Specify the distance that sound beams travel for each channel. The distance starts at this unit, ends at the listening position, and includes refraction off a wall and ceiling. The audio delay is adjusted and sound from each channel arrives at the listening position simultaneously.

Settings

Front L, Front R, Center, Surround L, Surround R, Height L, Height R

Adjustable range

0.3 m to 24.0 m (1.0 ft to 80.0 ft)

The length of each arrow indicates the beam travel length.

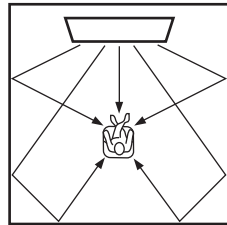

- Configure this setting only when you have adjusted "Horizontal Angle" or "Vertical Angle".

Focal Length

Setup Menu



Beam



Focal Length

Expand the optimal listening area (sweet spot).

The illustration below shows how output from all channels is once concentrated in a focal point and then expanded from that point. Apply negative (-) values to broaden the sweet spot, or positive (+) values to narrow the sweet spot.

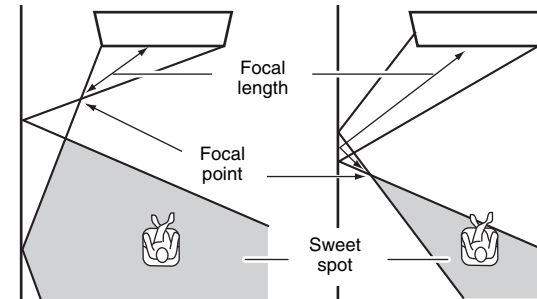

Settings

Front L, Front R, Surround L, Surround R, Height L, Height R

Adjustable range

-1.0 m to +13.0 m (-3.5 ft to +43.5 ft)

Setting

Center

Adjustable range

-1.0 m to +13.0 m (default: -0.5 m) (-3.5 ft to +43.5 ft (default: -1.5 ft))

We recommend using the default setting (-0.5 m or -1.5 ft) for “Center”.

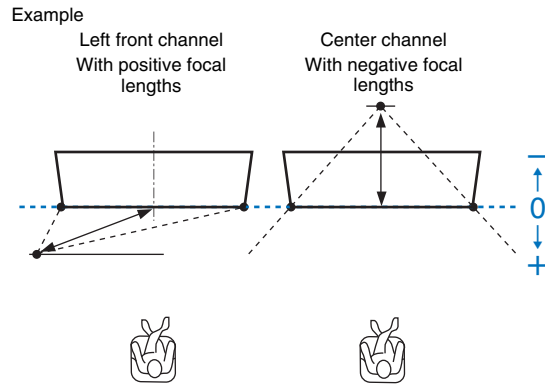

- “AUTO SETUP” (p. 30) automatically enables a range for optimal listening (sweet spot) that is broader than the width of this unit.

Image Location

Setup Menu



Beam



Image Location

If sound from the left and right channels is unnatural, first adjust the volume of each channel (p. 42, 74).

If this does not resolve the problem, adjust left- and right-channel image location.

Use to adjust the direction from which the front left and right channel sound is heard so that each sound can be heard closer to the center channel.

Adjustment

Settings

Off (default)	No adjustments are made.
On	Choose “Left” or “Right” to adjust the direction from which sound is heard.

Left

The higher the percentage, the louder the output from the center channel.

Once “Adjustment” has been set to “On”, this setting can be selected.

Adjustable range

0% (default) to 95%

Sound from the left front channel is unnatural

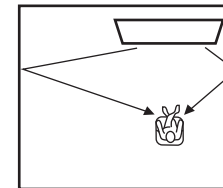

With the left front channel adjusted

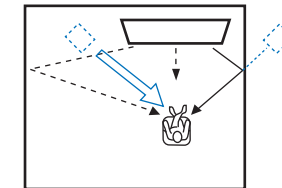

Right

The higher the percentage, the louder the output from the center channel. Once "Adjustment" has been set to "On", this setting can be selected.

Adjustable range

0% (default) to 95%

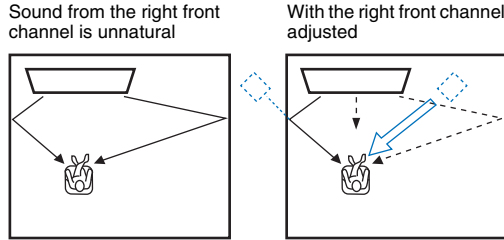

Channel Out



Specify the output method for each channel.

Front

Specify whether sound beams or normal sounds are output from the front channels.

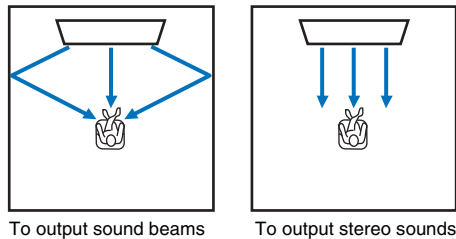

Settings

Beam	Sound beams are output from the left front, right front, and center channels. This setting is effective for creating sound fields greater than the dimensions of the actual listening room for playback of movies and the like.
Stereo	No sound beams are output from the left front, right front, and center channels. Front channel audio comes from the direction of the screen. Therefore, this setting is effective for enjoying music content such as live music videos.



- This setting is not available when "My Surround" is selected.
- When manually adjusting sound beams for the front channels, set "Front" to "Beam". Adjustment is not possible if "Front" is set to "Stereo".

Surround Back

Specify whether or not surround back channels are present.

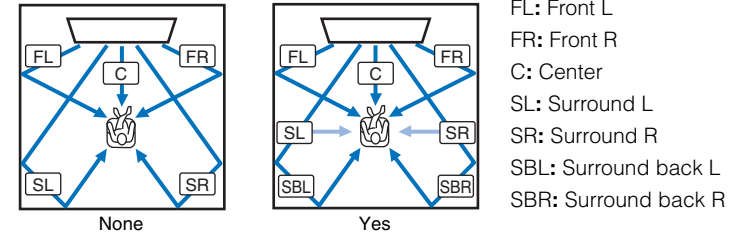

Settings

None	Sounds are played back without using surround back channels. Left and right surround channel audio is played back using sound beams that come from behind the listening position.
Yes	Sounds are played back using surround back channels. Left and right surround back channel audio is played back using sound beams that come from behind the listening position. Left and right surround channel audio is output using both sound beams that come from the front channels and from behind the listening position. This allows sounds to be heard from the sides of the listening position as well.
Auto (default)	Automatically select whether or not surround back channels are used based on the number of channels used for playback of the selected input source.

My Surround

Specify whether or not “My Surround” is enabled to reproduce a sense of surround sound even in a room not suitable for surround sound playback using sound beams.

Settings

Off (default)	My Surround is disabled.
On	“My Surround” is enabled. Enjoy playing audio with a good sense of surround sound even in an environment where surround sound playback using sound beams does not provide sufficient surround sound effects. Press the 3D SURROUND key or the SURROUND key on the remote control for playback using the My Surround function.



- To use “My Surround”, establish the listening position directly in front of the unit for a greater sense of surround sound.



- When “My Surround” is set to “On”, CINEMA DSP is disabled.
- When “My Surround” is set to “On”, Dolby Atmos playback or playback using height channels is not possible.

Subwoofer

Setup Menu



Beam



Subwoofer

Specify whether or not the subwoofer will be used, how it will be connected, and its distance to the listening position.

Bass Out

Specify whether or not the subwoofer will be used and how it is connected.

Settings

Front/Wireless (default)	Select when the subwoofer will not be used, or when the wireless subwoofer kit will be used.
Wired	Select when the subwoofer is connected to the unit with a cable.

Cross Over

Specify the upper limit of audio frequencies output from the subwoofer (the lower limit of audio frequencies output from the unit).

Settings

80 Hz, 100 Hz (default), 120 Hz

Distance

Specify the distance from the subwoofer to the listening position.

Adjustable range

0.3 m (1.0 ft) to 15.0 m (50.0 ft) (default: 2.5 m (8.5 ft))

Pairing

Manually pair the unit with the wireless subwoofer kit.

After “Pairing” is selected, press the PAIRING button on the wireless subwoofer kit for three seconds.



- “Pairing” can be selected when “Bass Out” is set to “Front/Wireless”.

Sound

Channel Level



Adjust the volume of each channel to balance output levels. Use test sounds output from each channel to adjust volume for optimal balance.

Settings

Front L, Front R, Center, Surround L, Surround R, Height L, Height R, Subwoofer

Adjustable range

-20 to +20



- When "My Surround" of "Channel Out" is set to "On" the following items can be configured (p. 73).
 - Center
 - Surround L/R
 - Subwoofer

Adaptive DRC



Adjust this unit's volume and dynamic range for optimal balance. When "On" is selected, dynamic range is adjusted as follows for optimal listening at low volumes, such as might be used at night.

When the volume level is low:

Narrow the dynamic range. Loud sound is played back softer, and soft sound which is hard to be listened to is played back louder.

When the volume level is high:

Widen the dynamic range. For both soft and loud sounds, source sound is played back without adjusting volume.

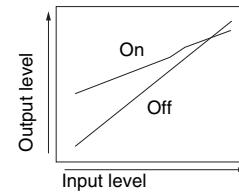

Volume: low

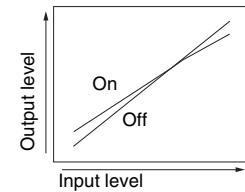

Volume: high

Settings

Off	The dynamic range is not adjusted automatically.
On (default)	Adjust the dynamic range automatically.



- When set to "On", "Dynamic Range" is automatically set to "Max".

Dynamic Range



Adjust this unit's dynamic range (difference between maximum and minimum volumes).

Settings

Min/Auto	Min: Sets dynamic range at a level that supports comfortable listening at low volumes. Auto: Sets dynamic range in accordance with information received from input signal.
Standard	The dynamic range recommended for regular home use.
Max (default)	Outputs sound without adjusting the dynamic range of the input signals.



- "Adaptive DRC" is automatically set to "Off" when the settings other than "Max" is selected.

DTS



Configure the DTS decoder for use with input of DTS audio signals.

Neural:X

Specify whether or not Neural:X is used to generate channels not present in input sources.

Settings

Disable	Neural:X will not be used.
Enable (default)	Neural:X will be used.



- Neural:X is the DTS:X surround sound decoder.

Dialog Control

Increase the volume of dialog to make listening easier.

Adjustable range

0 (default) to 6 (dB)



- This setting is effective only for playback of DTS:X input sources that support dialog control.

“Neural:X” and “Dialog Control” may be provided with a firmware update. See our website for the latest information.

The following settings are available for the DTS decoder before “Neural:X” and “Dialog Control” are provided with firmware update.

Configure the DTS Neo:6 decoder for use when DTS audio signals are input.

Settings

Neo:6 Cinema (default)	Use the DTS Neo:6 decoder suitable for movies.
Neo:6 Music	Use the DTS Neo:6 decoder suitable for music.



- The DTS Neo:6 decoder is disabled with stereo playback and target playback.

HDMI

Use to configure the settings related to HDMI signals and the HDMI control function.

HDMI Control



Turn HDMI control (p. 34) on or off.

Settings

Off (default)	Disable the control function. The standby power consumption of this unit decreases.
On	Enable the control function.

HDMI Audio Out

This setting can be configured only when “HDMI Control” is set to “Off”.



Use to select a device to play back HDMI audio signals.

Settings

AMP (default)	Play back the input sound signal.
TV	Plays audio content from the TV connected to the HDMI OUT (ARC) jack.



- When “HDMI Control” is set to “On”, select the audio output device based on the settings configured for the TV connected to this unit.
- HDMI video signals input to one of the HDMI IN jacks of this unit are always output from the HDMI OUT (ARC) jack of this unit.

TV Input



If your TV is not ARC compatible (or if the ARC feature has been disabled), TV audio is input via the TV (digital optical) jack (default). This unit's input source can be changed to the AUX2 (digital coaxial) jack or AUX1 (analog) jack.

Settings

Optical [TV] (default), Analog [AUX1], Coaxial [AUX2]



- If this unit's input source is switched to “Coaxial [AUX2]”:
Audio is input from the device (TV) connected to the AUX2 (digital coaxial) jack on this unit when the TV key is pressed. Audio is input from the device connected to the TV (digital optical) jack on this unit when the AUX2 key is pressed.
- If this unit's input source is switched to “Analog [AUX1]”:
Audio is input from the device (TV) connected to the AUX1 (analog) jack on this unit when the TV key is pressed. Audio is input from the device connected to the TV (digital optical) jack on this unit when the AUX1 key is pressed.

Display

Dimmer

Setup Menu → Display → Dimmer

Adjust the brightness of the front panel display and indicators. The smaller the value, the dimmer the display and indicators.

Settings

-4 (darkest) to 0 (brightest) (default)



- When the STATUS indicator glows red, the display is at maximum brightness regardless of this setting.
- When the Eco function is activated, this function cannot be configured (p. 43).

OSD Language

Setup Menu → Display → OSD Language

Use to select the language used for menus displayed on the TV screen.

Settings

日本語	Menus are displayed in Japanese.
ENGLISH (default)	Menus are displayed in English.
DEUTSCH	Menus are displayed in German.
FRANÇAIS	Menus are displayed in French.
ESPAÑOL	Menus are displayed in Spanish.
ITALIANO	Menus are displayed in Italian.
NEDERLANDS	Menus are displayed in Dutch.
РУССКИЙ	Menus are displayed in Russian.
SVENSKA	Menus are displayed in Swedish.
TÜRK	Menus are displayed in Turkish.



- Hold down the SETUP (⚙️) key to display “OSD Language” directly on the TV screen.
- The settings may be changed automatically when using the TV which supports the HDMI control function.
- Display language can only be selected for menus displayed on the TV screen. Information in the front panel display is displayed in English.

Distance Unit

Setup Menu → Display → Distance Unit

Use to change the display unit of measurement.

Settings

Meters (default setting other than U.S.A. and Canada models), Feet (default setting for U.S.A. and Canada models)



- If the unit used with measurement displays is changed from “Meters” to “Feet”, or vice versa, configure settings again to reflect the change in unit. The change will not be reflected with current settings.

Information

Display information for the audio and video signal input to this unit.

Audio



The following information on the current audio input signal is displayed.

Format	Digital audio format
Number of channels	The number of channels contained within the input signal—front/surround/low field effects (LFE). Example: "3/2/0.1" means signal contains 3 front channels, 2 surround channels, and LFE. If the signal contains channels other than front, surround, and LFE, the total number of channels may be displayed. Example: "7.1.2ch" (the last number 2 indicates the height channels)
Sampling frequency	The sampling frequency of the digital input signal
Bit rate	The per-second bit rate of the input signal



- The audio bit rate may not be displayed for some input signals.

Video



The following information on the current video input signal is displayed.

Type	HDMI or DVI
Resolution	Video signal resolution

System



Display the version of firmware currently installed on this unit.

Network

Configures the network settings.

Information



Display the network information on the unit.



- The options displayed vary according to the type of network connection (Wired/Wireless (Wi-Fi)/Wireless Direct).

Status	The connection status of the NETWORK jack
Connection	Connection method
MC Network	The connection status of MusicCast Network
SSID	The access point to which the unit is connected
Security	The encryption method for your network
MAC Address	MAC address (Ethernet/Wi-Fi)
IP Address	IP address
Subnet Mask	Subnet mask
Default Gateway	The IP address of the default gateway
DNS Server (P)	The IP address of the primary DNS server
DNS Server (S)	The IP address of the secondary DNS server
vTuner ID	The ID of the Internet radio (vTuner)

Network Connection

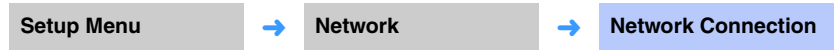

Select the network connection method.

Settings

Wired	Select this option when connecting the unit to a network with a network cable (not supplied).
Wireless (Wi-Fi)	Select this option when connecting the unit to a network via the wireless router (access point).
Wireless Direct	Select this option when connecting a mobile device to the unit directly.

IP Address



Configure the network parameters (such as IP address).

DHCP

Select whether to use a DHCP server.

Settings

Off	The DHCP server is not used. Configure the network parameters manually. For details, see "Manual network settings".
On (default)	The DHCP server is used to automatically obtain the unit's network parameters (such as IP address).

Manual network settings

1 Set "DHCP" to "Off".

2 Use the ▲/▼ keys to select a parameter type.

IP Address	Specify an IP address.
Subnet Mask	Specify a subnet mask.
Default Gateway	Specify the IP address of the default gateway.
DNS Server (P)	Specify the IP address of the primary DNS server.
DNS Server (S)	Specify the IP address of the secondary DNS server.

3 Use the ◀/▶ keys to move the edit position and the ▲/▼ keys to select a value.

4 Press the ENTER key.

MAC Address Filter



The MAC address filter limits network devices that can be used to operate the unit. When operating the unit via an app on a mobile device, specify the MAC address of the device.



- Operation of the AirPlay function (p. 63) or DLNA-compatible device (p. 60) is not limited by this setting.

Filter

Enable/disable the MAC address filter.

Settings

Off (default)	Disable the MAC address filter.
On	Enable the MAC address filter. In "MAC Address 1–10", specify the MAC addresses of the network devices that will operate the unit.

MAC Address 1–10

Specify the MAC addresses (up to 10) of the network devices that will operate the unit when "Filter" is set to "On".

1 Use the ▲/▼ keys to select an MAC address number (1 to 10).

2 Use the ◀/▶ keys to move the edit position and the ▲/▼ keys to select a value.

3 Press the ENTER key.

Network Standby

Setup Menu → Network → Network Standby

Turn the function that controls the unit's power (Network Standby) when a network device or *Bluetooth* device is operated on or off.

Settings

Off	Disable the network standby function.	
		The unit will turn on when the dedicated MusicCast CONTROLLER or HOME THEATER CONTROLLER (WLAN) app installed on your mobile device is used to initiate playback while the unit is off.
On (default)	Enable the network standby function.	<p>The unit will turn on and off in accordance with the following <i>Bluetooth</i> device operations.</p> <p>Coordinated power on When a <i>Bluetooth</i> device is connected to this unit while it is off, this unit turns on and the input source switches to BLUETOOTH.</p> <p>Coordinated power off When a <i>Bluetooth</i> device is disconnected from this unit while it is on, this unit turns off. (Only when BLUETOOTH is selected as the input source.)</p>



- The unit consumes more power when "Network Standby" is set to "On" than when it is set to "Off".

Network Name

Setup Menu → Network → Network Name

Edit the name displayed for this device (the unit's name on the network) on other network devices. A name up to 15 characters in length may be specified.

- 1 Use the ◀▶ keys to move the edit position and the ▲▼ keys to select a character.

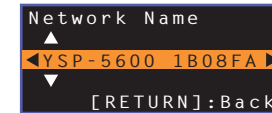

- The following alphanumeric characters and symbols may be used.
() [] { } < > * ! ? # % & . , ; _ | / \ \$ ~ ^ ' " ` 0-9 @ + - = A-Z a-z

- 2 Press the RETURN (↵) key.

Network Update

Setup Menu → Network → Network Update

Update the firmware via the network.

Perform Update

This option is available after firmware has been updated. For details, see "Updating the unit's firmware" (p. 87).

Bluetooth

Configures the *Bluetooth* settings.

Bluetooth



Enables/disables the *Bluetooth* function.

Settings

Off	Disable the <i>Bluetooth</i> function.
On (default)	Enable the <i>Bluetooth</i> function.

Transmission



Transmit audio from the unit to *Bluetooth* speakers or headphones.

Settings

Off (default)	Audio can not be transmitted.
On	Audio input to the unit can be transmitted to <i>Bluetooth</i> speakers or headphones.

Device Search

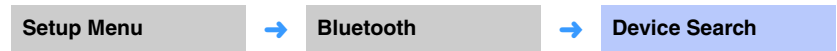

Select the *Bluetooth* speakers or headphones to which audio will be transmitted, and connect the unit to the speakers or headphones wirelessly.

MAC Address



Display the MAC address for the *Bluetooth* connection.

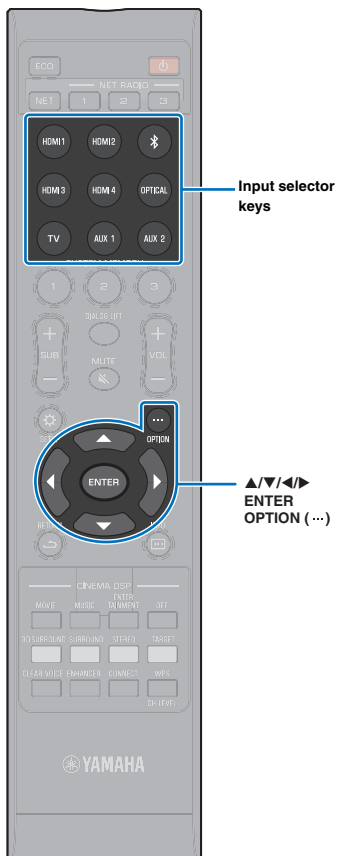

Settings each input source (Option menu)

Configure the functions related to the input source currently playing back content.

The option menu is displayed on, and operated from, the TV screen. See “Displaying the menu screen on the TV” (p. 27) for instructions on displaying the option menu on the TV.

Setting the option menu

1 Press the input selector key for the input source to be configured.

2 Press the OPTION (...) key.



3 Select the items by pressing the ▲/▼ key, then press the ENTER key or ► key.

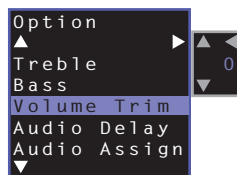

4 Change setting value by pressing the ▲/▼ key.

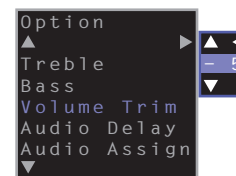

5 Press the OPTION (...) key to exit the option menu.



- The configurable items vary depending on the input source selected.

Option menu list

Menu	Description	Input
Treble	Adjust the output level of high (treble) tones.	HDMI1- 4, TV, OPTICAL, AUX1- 2, <i>Bluetooth</i> , NET (such as an internet radio station)
Bass	Adjust the output level of low (bass) tones.	HDMI1- 4, TV, OPTICAL, AUX1- 2, <i>Bluetooth</i> , NET (such as an internet radio station)
Volume Trim	Adjust the input level for each jack to compensate for variations in volume.	HDMI1- 4, TV, OPTICAL, AUX1- 2, <i>Bluetooth</i> , NET (such as an internet radio station)
Audio Delay	Adjust deviations in timing between audio and video playback.	HDMI1- 4, TV, OPTICAL, AUX1- 2
Audio Assign	When an HDMI device is selected as the input source, audio from a different input source is assigned to HDMI audio.	HDMI1- 4

Adjusting tones (Treble, Bass)

Adjust the output level of high (treble) and low (bass) tones.

Adjustable range

-12 to +12 (default: 0)

Adjusting input level of each jack (Volume Trim)

Adjust the input level for each jack to compensate for variations in volume.

Adjustable range

-12 to +12 (default: 0)

Audio delay control (Audio Delay)

TV images sometimes lag behind the sound. You can use this function to delay the sound output to synchronize it with the video image.

Adjustable range

HDMI1- 4: AUTO (default), 0 ms to 500 ms, 5 ms increments

TV, OPTICAL, AUX1- 2: 0 ms (default) to 500 ms, 5 ms increments

When "AUTO" is selected, output timing is automatically adjusted. This setting is only available when the TV connected via HDMI cable supports the audio delay automatic adjustment feature.

Assigning HDMI audio to a different input jack (Audio Assign)

When HDMI1- 4 is the selected input source, sound can be input from the OPTICAL jack rather than the HDMI IN jack.

Use this function to listen to sound from a different playback device while watching video of the BD/DVD player.

Settings

HDMI (default), OPTICAL

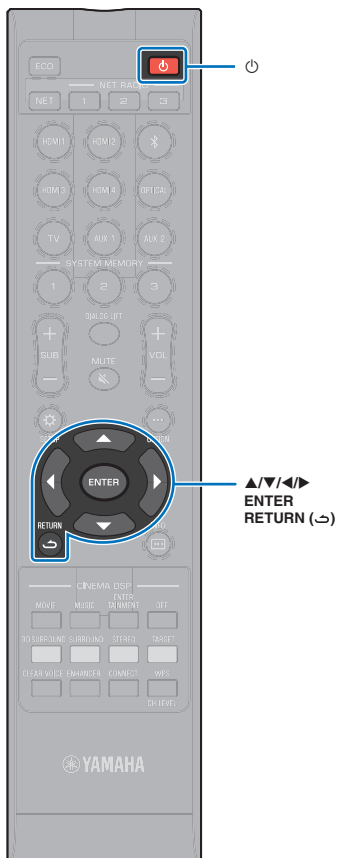

Advanced setup

The advanced setup enables more precise configuring of this unit's function. For example, maximum volume can be specified and the INPUT key on the top panel can be disabled.

Setting the advanced setup

- 1 Press the  key to turn off this unit.
- 2 While holding down the INPUT key on the top panel, press the  key on the remote control to turn on the power.

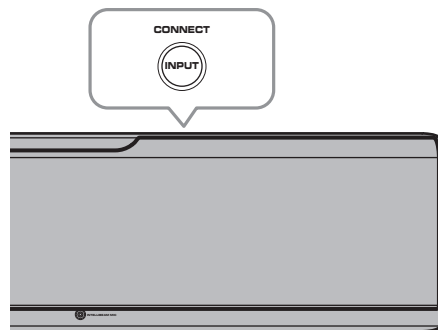



“ADVANCED” appears in the front panel display.

ADVANCED





• The advanced setup menu is not displayed on the TV screen.

- 3 Release the INPUT key on the top panel.

- 4 Use the  key to display the desired menu in the front panel display and then press the  key or ENTER key.



• To return to the previous menu, press the  or RETURN () key.

- 5 Use the  key to change setting.

- 6 Press the  key to turn off this unit.

The new setting is reflected when you turn on the unit by pressing the  key.

Advanced setup list

Menu	Settings/Adjustable range	Description
TURN ON VOLUME	OFF (Not set) (default), 1 to 70	Set the initial volume level when the power of this unit is turned on. When set to "OFF", volume level is the same as when this unit is turned off.
MAX VOLUME	1 to 99, MAX (Maximum) (default)	Set the maximum volume level so that this unit will not output sound beyond the limited volume level.
INPUT LOCK	ON (INPUT key operation is disabled) OFF (INPUT key operation is enabled) (default)	Select whether or not to enable the INPUT key on the unit.
PANEL LOCK	ON (Key operation on the unit is disabled) OFF (Key operation on the unit is enabled) (default)	Select whether or not to enable key operations on the unit (except the advanced setup operations).
IR INPUT POWER	ON (Enables power-on) OFF (Disables power-on) (default)	Select whether or not to automatically turn on this unit by pressing an input selector key on the remote control when the unit is turned off.
AC ON STANDBY	ON (Enters standby mode) (default) OFF (Restores the state before power was lost)	Set this unit's power to off when the AC power is recovered after the power to this unit was lost temporarily (disconnect the AC power plug from the wall outlet, power outage, etc.).
MEMORY PROTECT	ON (Protect is performed) OFF (Protect is not performed) (default)	Protect settings stored in system memory, and Internet radio stations registered with the unit.
YRB FL	YES (The reflection board is used) NO (The reflection board is not used) (default)	Use the YRB-100 sound reflection board for the front left channel. Refer to page 99 for details of YRB-100.
YRB FR	YES (The reflection board is used) NO (The reflection board is not used) (default)	Use the YRB-100 sound reflection board for the front right channel. Refer to page 99 for details of YRB-100.
YRB SL	YES (The reflection board is used) NO (The reflection board is not used) (default)	Use the YRB-100 sound reflection board for the surround left channel. Refer to page 99 for details of YRB-100.
YRB SR	YES (The reflection board is used) NO (The reflection board is not used) (default)	Use the YRB-100 sound reflection board for the surround right channel. Refer to page 99 for details of YRB-100.
AUTO POWER STANDBY	ON (This unit turns off automatically) (default setting for U.K., Europe and Russia models) OFF (This unit does not turn off automatically) (default setting other than U.K., Europe and Russia models)	When set to "ON", this unit turns off automatically in any of the following situations: <ul style="list-style-type: none"> • Audio is coming from the selected input source, but no operations have been performed for 8 hours or more. • HDMI1–4, <i>Bluetooth</i> or NET is selected as the input source, but no audio has been input to the unit or no operations have been performed with the unit for more than 20 minutes.
NOTICE OF NEW FW	ON (Notify) (default) OFF (Do not notify)	Notifications will not be displayed on the TV screen when updates for the unit's firmware are provided via the network.
FW UPDATE	01.02 (The firmware version is displayed) Start OK? (Firmware is updated)	Confirm firmware version/update firmware.
INITIALIZE	INFO (Initialize all settings not related to the network) NET INFO (Initialize network related settings)* CANCEL (Do not initialize) (default)	Reset the parameters of this unit to the factory presets. When the unit is freed, the problem may solve by restoring to their default values. * The following configurations will be restored if "INFO" is selected. <ul style="list-style-type: none"> • Network Standby (p. 81) • Bluetooth (p. 45)



- Initializing this unit also initializes measurement results with IntelliBeam and settings stored in system memory. Perform "AUTO SETUP" from the "IntelliBeam" menu again (p. 29).

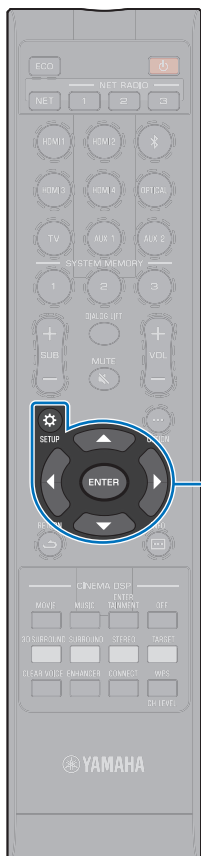

▲/▼
ENTER
SETUP (⚙️)

Updating the unit's firmware

New firmware that provides additional features or product improvements will be released as needed. If the unit is connected to the Internet, you can download the firmware via the network and update it.

When the unit is turned on for the first time after a new version of the unit's firmware has been released, a message indicating that a firmware update is available will be displayed on the TV screen, and an envelope icon (✉️) will be displayed in the setup menu (p. 66)

The unit's firmware can be updated as follows.

- Update firmware from "Network Update" in the setup menu.
- Update firmware by connecting a USB flash drive to which the unit's firmware update has been saved (p. 88).
- Update firmware using the dedicated MusicCast CONTROLLER app installed on a mobile device. Follow MusicCast CONTROLLER guides to operate the app and update the firmware.

Notes

- Do not operate the unit or disconnect the power cable or network cable during firmware update. Firmware update takes about 20 minutes or more (depending on your Internet connection speed).
- If the Internet connection speed is slow, or the unit is connected to the wireless network, network update may not be possible depending on the condition of the network connection. In this case, update the firmware using the USB flash drive (p. 88).
- To perform the following procedure, your TV must be connected to the unit via HDMI.
- For details on update, visit the Yamaha website.

Using "Network Update" in the setup menu to update firmware

- 1 Press the SETUP (⚙️) key twice.**
The setup menu is displayed on the TV screen.
- 2 Use the ▲/▼ keys to select "Network", and then press the ENTER key.**
- 3 Use the ▲/▼ keys to select "Network Update", and then press the ENTER key.**

The following screen is displayed when firmware updates are available.



- To cancel the operation without updating the firmware, press the SETUP (⚙️) key.

4 Press the ENTER key.

The TV screen goes black and firmware update begins.

Update progress is displayed on the front panel display while firmware is updated.

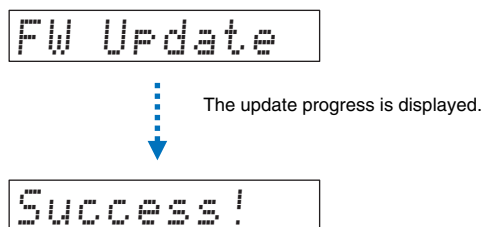

5 When “Success!” is shown in the front panel display, press the ⏻ key on the unit’s top panel.

The firmware update is complete.



- If the firmware update fails, use the ⏻ key to turn the unit off and then on again, and repeat the procedure from step 1 again.
- If “XXXXSumError” is displayed, a problem with communications over the network has occurred. Check communications status, use the ⏻ key to turn the unit off and then on again, and then repeat the procedure from step 1 again.

Updating firmware with connection of a USB flash drive

Download the latest firmware version from the Yamaha website to a USB flash drive, which can then be used to update the unit’s firmware.

See information provided when updating firmware for details.

- 1 Save this unit’s firmware to a USB flash drive.
- 2 Turn off the unit.
- 3 Connect the USB flash drive to the UPDATE ONLY jack on the unit’s rear panel.
- 4 Select “FW UPDATE” in the advanced setup menu, and press the ENTER key.
- 5 Use ▲/▼ key to select “Start OK?”, and press the ENTER key.

The firmware update begin.

Update progress is displayed on the front panel display while firmware is updated.

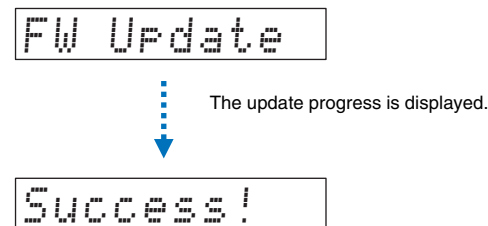

6 When “Success!” is shown in the front panel display, press the ⏻ key on the unit’s top panel.

The firmware update is complete.



- If the firmware update fails, use the \odot key to turn the unit off and then on again, and repeat the procedure from step 1 again. If the firmware update fails again, confirm the USB flash drive is correctly connected to the UPDATE ONLY jack.
- If any of the following messages are displayed, a problem has occurred during the update.
 - “Not found”:
The USB flash drive does not contain the firmware data. Use a PC to properly save the firmware data to the USB flash drive again.
 - “XXXXSumError”:
There is a problem with the data stored on the USB flash drive. Use a PC to confirm data on the USB flash drive.

DTS:X updates

The unit supports update to DTS:X Version 2, scheduled to be released shortly. An update to DTS:X Version 2 will be provided when the unit's firmware is updated. See the information provided with the firmware update for more information on DTS:X Version 2.

APPENDIX

Troubleshooting

Refer to the chart below when this unit does not function properly. If the problem you are experiencing is not listed below or if the instruction below does not help, turn off the unit, disconnect the AC power supply cable, and contact the nearest authorized Yamaha dealer or service center.

General

Problem	Cause	Remedy	See page
This unit does not operate properly.	The internal microcomputer has been frozen by an external electric shock (such as lightning or excessive static electricity) or by a power supply with low voltage.	Disconnect the AC power supply cable from the outlet and plug it again in after 30 seconds.	–
This unit fails to turn on when the  key is pressed, or the unit is turned off soon after the power has been turned on.	The AC power supply cable is not firmly connected to the AC wall outlet.	Connect the AC power supply cable firmly to the AC wall outlet.	26
	The internal microcomputer has been frozen by an external electric shock (such as lightning or excessive static electricity) or by a power supply with low voltage.	Disconnect the AC power supply cable from the outlet and plug it again in after 30 seconds.	–
	"PANEL LOCK" is set to "ON".	Set to "OFF".	85
This unit is suddenly turned off.	The internal temperature becomes too high and the overheat protection circuitry has been activated.	Wait for about 1 hour for this unit to cool down, turn it back on after confirming an adequate amount of ventilation space and not to cover this unit with a cloth.	12
	When the Auto Power Standby function is enabled, this unit turns off automatically in any of the following situations: – Audio is coming from the selected input source, but no operations have been performed for 8 hours or more. – HDMI1–4, <i>Bluetooth</i> or NET is selected as the input source, but no audio has been input to the unit or no operations have been performed with the unit for more than 20 minutes.	Turn on the power of the unit and play back the source again. If the Auto Power Standby function is not used, set "AUTO POWER STANDBY" to "OFF".	86
	The network standby function has been activated, terminating the <i>Bluetooth</i> connection.	Resume the <i>Bluetooth</i> connection using the <i>Bluetooth</i> device, or turn on this unit and disable the network standby function.	81

Problem	Cause	Remedy	See page	
No sound.	Incorrect input or output cable connections.	Connect the cable properly.	23	
	No appropriate input source has been selected.	Select an appropriate input source with the input selector keys.	36	
	The volume is turned down.	Turn up the volume.	36	
	The sound is muted.	Press the MUTE () or VOL (+/-) key to resume audio output and adjust the volume level.	36	
	There is input signal cannot be played back by this unit.	Play a source whose signals can be reproduced by this unit. Change the system settings of the source device.	106	
	"HDMI Audio Out" is set to "TV".	Set to "AMP".	76	
	"HDMI Control" is set to "Off".	When connecting ARC (Audio Return Channel) supported TV and this unit using an HDMI cable only, set "HDMI Control" to "On".		76
		To use this unit with "HDMI Control" set to "Off", connect the TV's audio output jack to this unit's TV (digital optical) jack via the optical cable.		22
Sound from an HDMI control-enabled TV is set for output from the TV's built-in speakers.	Use the TV's HDMI settings to set audio output to any option other than the TV's built-in speakers.		-	
No sound or too small sound from a specific channel.	The output level of the channel is muted.	Raise the output level of the channel.	42, 74	
	The beam setting is inappropriate.	Adjust the beam setting.	29, 69	
	The source is played in stereo playback mode.	Switch to 3D surround/surround playback mode.	37, 38	
Surround sound effects are insubstantial.	When connecting this unit with playback device and TV digitally, the output setting of the playback device and TV is not valid.	Refer to documentation supplied with your device and check the setting.	-	
	The playback device is set for constant output from 2 channels (PCM, etc.).	Change the playback device's audio output setting.	-	
	The listening room is not a regular shape, or the unit or listening position is not at the center of the right and left wall of the listening room.	Relocate the unit or listening position.	13	
	There is no wall in the path of the sound beam.	Place the sound reflection board in the path of the sound beam.	99	
	When "My Surround" is set to "On", listening position is not in front of the unit.	Listen in front of this unit.	73	
Sounds from above cannot be clearly heard.	The angle of sound beams coming from the height channels is not properly set.	Apply 3D surround sound playback mode, and then set "Height L" and "Height R" for "Vertical Angle" in the setup menu to positions where audio can be more clearly heard.	37, 69	
	A playback mode other than 3D surround sound playback mode is being used for playback.	Use 3D surround sound playback mode for playback.	37	
	The ceiling is too high, or there are items protruding from the ceiling.	Change the unit's installation position or the listening position, and then perform AUTO SETUP again.	29	

Problem	Cause	Remedy	See page	
No sound coming out of the subwoofer.	Wired/Wireless	The AC power supply cable of the subwoofer is not firmly connected to the AC wall outlet.	Connect the AC power supply cable firmly to the AC wall outlet.	-
	Wired/Wireless	The volume of the subwoofer is low.	Increase the volume via the control on the subwoofer.	-
	Wired/Wireless	The subwoofer is turned off.	Turn on the subwoofer.	-
	Wired/Wireless	The subwoofer's Auto Standby function (the function that automatically turns it off) was activated.	Deactivate the subwoofer's Auto Standby function or adjust its operating sensitivity.	-
	Wired	The "Bass Out" item under "Subwoofer" is set to "Front/Wireless".	Set it to "Wired".	73
	Wireless	Conditions for wireless communications are not good, and the unit and the wireless subwoofer kit are not connected. (The indicator on the wireless subwoofer kit flashes green, or glows red.)	Move the wireless subwoofer kit closer to the unit. If the problem persists, move the wireless subwoofer kit to a location where its indicator steadily glows green.	-
			If there are obstacles such as metal furniture obstructing communications between the unit and the wireless subwoofer kit, rearrange the furniture or reposition the wireless subwoofer kit.	-
			If there are devices such as microwave ovens or wireless network devices that emit electromagnetic waves, move the unit and the wireless subwoofer kit away from these devices.	-
Unplug the power cable of the wireless subwoofer kit from the AC wall outlet, and then plug it in again.			-	
Wireless	The unit is not paired with the wireless subwoofer kit. (The indicator on the wireless subwoofer kit flashes red.)	Move the wireless subwoofer kit closer to the unit to improve conditions for wireless communications, and follow the instructions below to pair the two. After "Pairing" is selected for "Subwoofer" in the setup menu, press and hold the SUBWOOFER PAIRING button on the wireless subwoofer kit for three seconds to pair it with the unit. If the indicator on the wireless subwoofer kit does not glow green steadily after pairing, the unit may be malfunctioning. Disconnect the power cable and contact your nearest Yamaha dealer or service center to request repairs.	73	
Wireless	The subwoofer output is set to "Wired".	Set to "Front/Wireless".	73	
The volume of the subwoofer is low.	Wired/Wireless	The volume of the subwoofer is low.	Increase the volume via the control on the subwoofer.	-
			Increase the volume of the subwoofer with the SUB + key.	36
	Wired/Wireless	Content from an input source with a limited support for low tones is playing.	Play content from an input source with broader support for low tones to see if volume is still low.	-
	Wired/Wireless	The unit is in target playback mode.	Switch to 3D surround/surround playback mode or stereo playback mode.	37, 38, 40

Problem	Cause	Remedy	See page	
Sound from the subwoofer is intermittent.	Wired/Wireless	Cables used to connect the subwoofer to the unit (or the wireless subwoofer kit) are not connected firmly.	Connect the cables firmly.	25
	Wireless	Wireless communication conditions are not good, and the unit and the wireless subwoofer kit are not connected. (The indicator on the wireless subwoofer kit flashes green, or glows or flashes red.)	Move the wireless subwoofer kit closer to the unit. If the problem persists, move the wireless subwoofer kit to a location where its indicator steadily glows green.	–
			If there are obstacles such as metal furniture obstructing communication between the unit and the wireless subwoofer kit, rearrange the furniture and the wireless subwoofer kit.	–
			If there are devices such as microwave ovens or wireless network devices that emit electromagnetic waves, move the unit and the wireless subwoofer kit away from these devices.	–
The image is not displayed on TV screen.	The HDMI cable is not securely connected.	Connect the HDMI cable properly.	22, 23	
Menu screen of this unit is not displayed.	The input switch of TV is not set correctly.	Set the TV's input source to this unit.	27	
A digital or high-frequency equipment produces noises.	The unit may be placed close to digital equipment or high-frequency equipment.	Move the equipment away from the unit.	–	
The HDMI control function does not work properly.	"HDMI Control" is set to "Off".	Set "HDMI Control" to "On".	76	
	The HDMI control function is disabled on your TV.	Refer to documentation supplied with your TV and check the setting.	–	
	The number of the connected HDMI devices exceeds the limit.	Disconnect some of the HDMI devices.	–	
	Amplifiers (AV amplifiers, sound bars, etc.) other than the unit are connected to the TV or a playback device with an HDMI cable.	Connect only this unit to the TV or a playback device for use as an amplifier.	–	
Sound beams for the front channels cannot be adjusted manually.	"Front" of "Channel Out" is set to "Stereo".	Set to "Beam".	72	
Audio delay control function is not effective even "Audio Delay" is set to "AUTO".	The TV does not support the audio delay auto adjustment feature.	Adjust timing of sound output manually from "Audio Delay" in the option menu.	84	
"Disable" appears in the front panel display after key operation.	The key is unable to function in the current status of the unit.	_____	–	

Bluetooth

Problem	Cause	Remedy	See page
Receiving Unable to connect the unit to a Bluetooth device.	"Bluetooth" is set to "Off".	Set it to "On".	82
	"Transmission" is set to "On".	Set it to "Off".	82
	Bluetooth is not selected as the input source.	Select <i>Bluetooth</i> as the input source.	46
	Another <i>Bluetooth</i> device is connected.	Terminate the current <i>Bluetooth</i> connection, and connect to the device from which audio should be received.	45, 46
	A <i>Bluetooth</i> adaptor, etc. that you want to connect to the unit has a password other than "0000".	Use a <i>Bluetooth</i> adaptor, etc. whose password is "0000".	45
	The device does not support A2DP.	Connect to a <i>Bluetooth</i> audio device that supports A2DP.	105
	As more than 20 devices have been connected, information for the oldest connection has been deleted.	Connect to the device again. The unit is can connect to up to 20 <i>Bluetooth</i> devices for receiving and transmitting audio. If a new device is successfully connected to the unit after 20 other devices have already been connected, the device with the earliest connection date will have been deleted to make room for the new device.	45, 46
	The unit and device are too far apart.	Position the <i>Bluetooth</i> device so that it is less than 10 m (33 ft) from this unit and connect the device to this unit.	45, 46
	There is a device (microwave oven, wireless LAN, etc.) outputs signals in the 2.4 GHz frequency band nearby.	Move this unit away from the device that is emitting radio frequency signals.	–
No sound is heard or the sound is intermittent via the unit.	The device is not set to send <i>Bluetooth</i> audio signals to the unit.	Check that the <i>Bluetooth</i> function of the device is set properly.	–
	Playback on the device has not been performed.	Perform playback on the device.	–
	The device's volume is set to minimum.	Turn up the volume level on the device.	–
	The unit and device are too far apart.	Move the <i>Bluetooth</i> device so that it is less than 10 m (33 ft) from this unit.	45, 46
	There is a device (microwave oven, wireless LAN, etc.) outputs signals in the 2.4 GHz frequency band nearby.	Move this unit away from the device that is emitting radio frequency signal.	–
	The <i>Bluetooth</i> connection of the unit with the device is disconnected.	Perform <i>Bluetooth</i> connection operations again.	46

Problem	Cause	Remedy	See page
Transmitting Cannot make the unit connected to the <i>Bluetooth</i> device.	"Bluetooth" is set to "Off".	Set it to "On".	82
	"Transmission" is set to "Off".	Set it to "On".	82
	Another <i>Bluetooth</i> device is connected.	Terminate the current <i>Bluetooth</i> connection, and connect to the device to which audio should be transmitted.	45, 48
	The device does not support A2DP.	Connect to a <i>Bluetooth</i> audio device that supports A2DP.	105
	More than 20 devices are connected and the earliest connecting information is deleted.	Connect to the device again. The unit is able to connect up to 20 <i>Bluetooth</i> devices for receiving and transmitting audio. If a new device is successfully connected to the unit after 20 other devices have already been connected, the device with the earliest connecting date will have been deleted to make room for the new device.	45, 48
	The unit and device are too far apart.	Position the <i>Bluetooth</i> device so that it is less than 10 m (33 ft) from this unit and connect the device to this unit.	45, 48
	There is a device (microwave oven, wireless LAN, etc.) outputs signals in the 2.4 GHz frequency band nearby.	Move this unit away from the device that is emitting radio frequency signals.	-
No sound is heard or the sound is intermittent via the <i>Bluetooth</i> device.	The device is not set to send <i>Bluetooth</i> audio signals to the unit.	Check that the <i>Bluetooth</i> function of the device is set properly.	-
	The device's volume is set to minimum.	Turn up the volume level on the device.	-
	Transmitted audio does not play.	Play audio from the device selected with the input selector key.	48
	The unit and device are too far apart.	Move the <i>Bluetooth</i> device so that it is less than 10 m (33 ft) from this unit.	45, 48
	There is a device (microwave oven, wireless LAN, etc.) outputs signals in the 2.4 GHz frequency band nearby.	Move this unit away from the device that is emitting radio frequency signals.	-
	The <i>Bluetooth</i> connection of the unit with the device is disconnected.	Perform <i>Bluetooth</i> connection operations again.	48
	Attempted to establish a connection during playback with AirPlay.	Playback with AirPlay cannot be transmitted. Terminate AirPlay playback and try again to establish a connection.	48, 63

Remote control

Problem	Cause	Remedy	See page
The remote control does not work and/or function properly.	The wrong distance or angle.	The remote control functions within a maximum range of 6 m (20 ft) and no more than 30 degrees off-axis from the front panel.	7
	Direct sunlight or lighting (from an inverter type of fluorescent lamp, etc.) is striking the remote control sensor of this unit.	Reposition this unit.	-
	The batteries are weak.	Replace all batteries.	7

Network

Problem	Cause	Remedy	See page
The network feature does not function.	The network parameters (IP address) have not been obtained properly.	Enable the DHCP server function on your router and set "DHCP" in the setup menu to "On" on the unit. If you want to configure the network parameters manually, check that you are using an IP address which is not used by other network devices in your network.	80
"Not connected" is displayed with "Wireless (Wi-Fi)" configuration; unable to connect to wireless router (access point).	The wireless router's MAC address filter is enabled.	A connection cannot be established if the wireless router's MAC address filter is enabled. Check wireless router (access point) settings and try a different connection method.	50, 80
"Not connected" is displayed with "Wireless (Wi-Fi)" configuration using the WPS function ("WPS Button" and "PIN Code") and "Access Point Scan"; unable to connect to wireless router (access point).	The wireless router (access point) does not broadcast its SSID.	A connection cannot be established if the wireless router (access point) is configured so that it does not broadcast its SSID. Check wireless router (access point) settings and try a different connection method.	53, 57
"Not connected" is displayed with "Wireless (Wi-Fi)" configuration using the WPS function ("WPS Button" and "PIN Code"); unable to connect to wireless router (access point).	The wireless router (access point) uses WEP encryption.	A connection cannot be established using the WPS function. Try a different connection method.	53, 57
Playback stops unexpectedly and files cannot be played continuously.	The folder contains some files that cannot be played via the unit.	Delete or move files (including video or hidden files) that cannot be played via the unit from the folder.	–
The unit does not detect the PC.	The media sharing setting is not correct.	Configure the sharing setting and select the unit as a device to which music contents are shared.	60
	Some security software installed on your PC is blocking the access of the unit to your PC.	Check the settings of security software installed on your PC.	–
	The unit and PC are not in the same network.	Check the network connections of the unit and PC, and then connect the unit and the PC to the same network.	–
	The MAC address filter is enabled on the unit.	In "MAC Address Filter" in the setup menu, disable the MAC address filter or specify the MAC address of your PC to allow it to access to the unit.	80
The files in the PC cannot be viewed or played back.	The files are not supported by the unit or the media server.	Use the file format supported by both the unit and the media server.	60

Problem	Cause	Remedy	See page
The Internet radio cannot be played.	The selected Internet radio station is currently not available.	There may be a network problem at the radio station, or the service may have been stopped. Try the station later or select another station.	-
	The selected Internet radio station is currently broadcasting silence.	Some Internet radio stations broadcast silence at certain times of the day. Try the station later or select another station.	-
	Access to the network is restricted by the firewall settings of your network devices (such as the router).	Check the firewall settings of your network devices. The Internet radio can be played only when it passes through the port designated by each radio station. The port number varies depending on the radio station.	-
The dedicated apps for mobile device does not detect the unit.	The MAC address filter is enabled on the unit.	In "MAC Address Filter" in the setup menu, disable the MAC address filter or specify the MAC address of your mobile device to allow it to access to the unit.	80
	The unit and mobile device are not in the same network.	Check the network connections and your router settings, and then connect the unit and mobile device to the same network.	-
Firmware update via the network (Network Update) fails.	It may not be possible depending on the condition of the network.	Update the firmware via the network (Network Update) again or use a USB flash drive.	87
The iPod does not recognize the unit when using AirPlay.	The unit and iPod/mobile device are connected to different SSIDs on the same access point.	Check the network connections for the unit and your mobile device, and connect them to the same SSID.	-
The app installed on a mobile device does not recognize the unit.			
The unit cannot connect to the Internet via a wireless router (access point).	The wireless router (access point) is turned off.	Turn on the wireless router (access point).	-
	The unit and the wireless router (access point) are too far apart.	Place the unit and the wireless router (access point) closer to each other.	-
	There is an obstacle between the unit and the wireless router (access point).	Move the unit and the wireless router (access point) in a location where there are no obstacles between them.	-
Wireless network is not found.	There is a device (microwave oven, wireless LAN, etc.) outputs signals in the 2.4 GHz frequency band nearby.	Move this unit away from the device that is emitting radio frequency signals.	-
	Access to the network is restricted by the firewall settings of the wireless router (access point).	Check the firewall setting of the wireless router (access point).	-

Messages in the front panel display

Message	Description	See page
ViewScreen	This unit's setup menu is displayed on the TV screen. Use the TV screen to configure settings.	66
Key Locked	The keys on the unit are locked. Use the remote control.	85
Sleep XXmin	The Auto Power Standby function will turn this unit off in XX minutes.	85
Protected	SYSTEM MEMORY 1-3 and NET RADIO 1-3 are protected.	85
Disable	Key operation is disabled.	-

When surround effect is not enough

The unit achieves its surround sound effects by projecting sound beams which reflect off walls. The sound beams are not reflected toward to the listening position caused by furniture, etc., in the path of sound beams, or the room shape. In this case, the sound may become unbalanced.

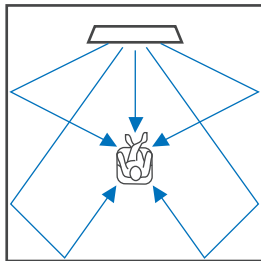

Figure 1. Ideal condition

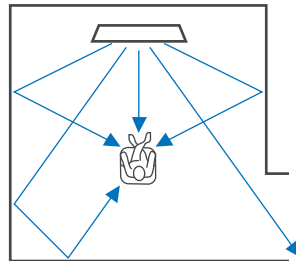

Figure 2. Surround right beam is not being reflected because there is no wall.

Surround right is quieter than surround (left), or surround right is in front of its proper location.

If the sound beams are not reflected toward to the listening position (figure 2), you can adjust for this by installing the optional sound reflection board YRB-100.

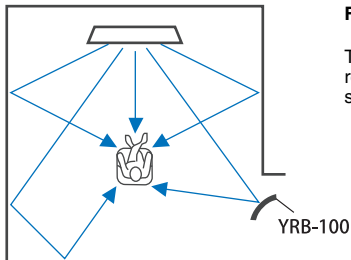

Figure 3. With a sound reflection board installed

The sound beam for surround right is reflected correctly, and correct surround sound effect is achieved.

Installing and adjusting the sound reflection board YRB-100

1 Decide the position of the sound reflection board.

Install the sound reflection board as shown in the picture.



- Always hold the pole when moving the sound reflection board.



- Use "Channel Level" in the setup menu (p. 74) to determine the precise direction from which sounds are difficult to hear.

Recommended position for installation

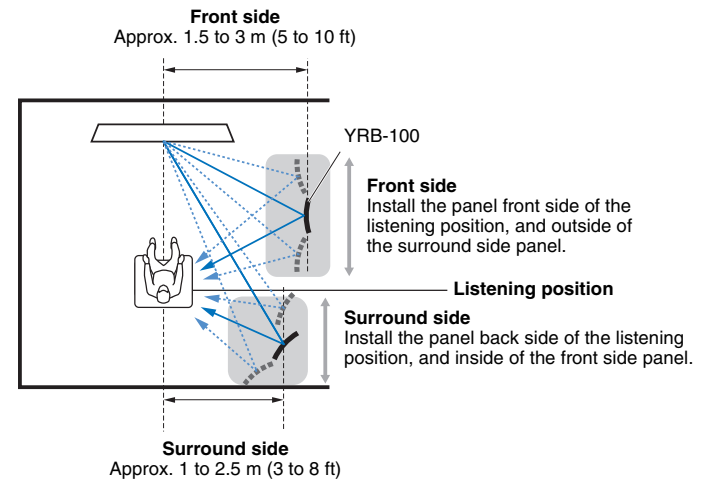

- YRB-100 may not be available in some countries or regions.

2 Use advanced setup (p. 85) to configure the sound reflection board.

Set “YRB FL” (FL), “YRB FR” (FR), “YRB SL” (SL), and “YRB SR” (SR) to “YES” depending upon the position of the sound reflection board to be installed.

Color bars are displayed across the entire TV screen. This makes it easier to recognize whether the TV screen is reflected in the panel when determining the proper angle of the panel in step 4, to the left or right.

3 Adjust the height.

Adjust the height of the sound reflection board panel based on the position of the unit and the sound reflection board, as well as the listening position.

See the YRB-100 Owner’s Manual for more information.

4 Adjust the angle of the panel left or right.

Adjust the angle of the panel so that sound beams are reflected toward the listening position.

Turn on the TV and dim the lights in the room. If you see the TV screen (color bar display) reflected in the panel from your listening position, the angle of the panel is properly adjusted.

See the YRB-100 Owner’s Manual for more information.

5 Press the key to turn this unit off. Press it a second time to turn this unit on again.

6 Plug the IntelliBeam microphone into this unit and then perform “AUTO SETUP” (Beam+Sound optimize) from the “IntelliBeam” menu (p. 30).

Be sure that the channels (FL, FR, SL, and SR) configured for the sound reflection board are displayed for “YRB” on the SHOW RESULT screen.

An asterisk (*) is displayed with a channel exhibiting poor sound beam reflection.

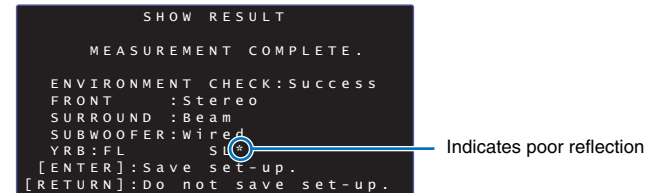

Should this occur, follow the instructions below to re-adjust the panel.

- ① Adjust the height and angle of the sound reflection board panel in accordance with installation conditions.
- ② Use “Channel Level” in the setup menu (p. 74) to confirm that the test sound is successfully reflected.
For greater precision, perform “AUTO SETUP” in the “IntelliBeam” menu, and then confirm that the asterisk (*) is no longer displayed with the channel.

If the asterisk (*) continues to be displayed, or if there is still no test sound reflected from the direction of the sound reflection board, follow directions in the YRB-100 Owner’s Manual to adjust sound beams manually.

Basic Knowledge of Surround Sound

What is a Digital Sound Projector?

A typical surround sound playback system uses 5 to 7 speakers. To configure a surround sound playback system that enables audio playback in the vertical direction, 2 or more additional speakers should also be installed above the listening position.

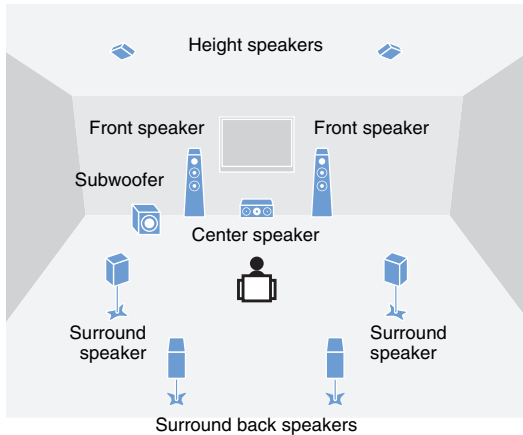

A highly realistic sound field can be created with multiple speakers installed around the listening position as shown in the illustration above. However, this can be difficult to do in a living room. The unit utilizes "digital sound projector" technology, enabling it alone to provide a realistic and engaging surround sound experience.

A digital sound projector provides optimal control over the delay time for each of the compact speakers installed in orderly rows, and drives the amplifier for each of these speakers, synthesizing audio signals output from each speaker as highly focused sounds (sound beams).

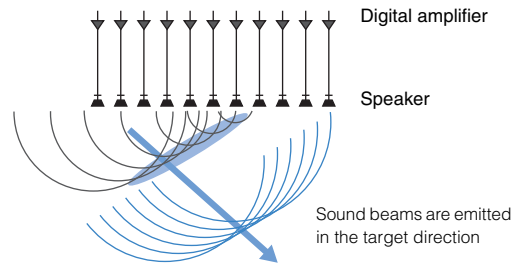

These focused sounds possess wave-like characteristics. When they hit a hard wall or ceiling, they are reflected off the wall or ceiling. A digital sound projector outputs sound beams from seven channels, including front (left/right), center, surround (left/right), and height (left/right) channels, by reflecting these beams off the walls and ceiling so that sounds reach the listener from the appropriate direction. It features a technology that enables true surround sound without requiring the installation of speakers behind or to the sides of the listener, or in the ceiling.

By combining sound beams coming from the front (left/right) and back (left/right), it can also create two new audio channels for surround sound playback using 7.1 channels in the horizontal direction. With this configuration, the new audio channels output sounds from surround sound channels, while sound beams coming from behind the listening position (left/right) output sounds from surround back channels.

The sound image of the system

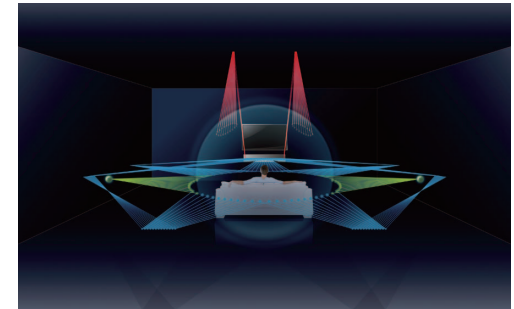

What is Object Based Audio?

With traditional audio technologies, which channels (speakers) should output what types of sounds when creating audio sources was pre-defined. This is called "channel-based audio". In contrast, new audio systems such as Dolby Atmos use a new technology called object-based audio. This technology processes each sound (e.g., the sound of a car or an actor's voice) contained in an audio source as an "object" and memorizes each object's sound changes and positional changes in a sound field to control these changes during playback. The greatest advantage of applying object-based audio to a home surround sound system is the power to control the audio output method based on device features and the number of speakers used for playback. The unit adjusts sound beam output according to the listening room setup. It calculates the movements of an object according to each playback environment and reproduces sound fields that best match the intentions of a sound director. It also enables audio output in the vertical direction so that each sound (object) in an audio source can freely move within a sound field.

Yamaha's Audio Technologies

This unit features many more functions based on Yamaha's superior audio technologies.

Compressed Music Enhancer

This technology enhances and extends bass and treble, which tend to be weak in digitally compressed formats such as MP3 used with portable digital audio players and computers. This makes compressed audio sound more musically dynamic.

CINEMA DSP/CINEMA DSP 3D

This technology enables precise digital recreation of actual acoustic environments found in well-known concert halls and movie theaters. This is achieved using Yamaha's exclusive sound field programs, which are based on data measured in various sound fields, and with which the amplitude, depth, and volume of sounds have been adjusted.

CINEMA DSP 3D uses three-dimensional sound field data, including vertical directional information, and further extends standard CINEMA DSP, to make sound field effects more realistic and three-dimensional.

Glossary

Sampling Frequency and Bit Depth

These are values that represent the amount of information used to convert analog signals to digital signals. They may be expressed as 48kHz/24bit, for example.

- **Sampling Frequency**

This defines the number of samples per second (sampling a finite set of discrete values in an analog signal). The higher the sampling rate, the broader the range of frequencies that can be played back.

- **Bit Depth**

This defines the amplitude value of sounds when quantifying analog signals as finite values. The higher the bit depth, the deeper sounds are reproduced.

Deep Color

This is a video technology supported by the HDMI standard. It processes RGB or YCbCr signals at bit depths of 10, 12, or 16 bits per color, whereas conventional formats utilize only 8-bit processing, enabling reproduction of more colors. Its gamut is comprised of a billion or more colors, while the gamuts of conventional formats are comprised of only millions of colors or less. This broader gamut results in more precise reproduction of colors and greater detail in darker portions.

Dolby Atmos

Dolby Atmos is an object-based surround sound technology developed by Dolby Laboratories. Traditional surround sound technologies record and control audio for each channel. Dolby Atmos records audio content as a collection of many objects (a combination of audio information and information related to movement of sound positions) and precisely controls content in accordance with various home theater environments for an acoustic environment more realistic and three-dimensional than ever before. Another advantage is the ability to record sounds coming from overhead. It was originally developed for movie theaters, but can also be applied to home devices.

Dolby Atmos content is provided in the Dolby True HD format, including Dolby Atmos streams, or in the Dolby Digital Plus format.

Dolby Digital

This is a compressed audio format for 5.1 channels. It was developed by Dolby Laboratories, and is widely used with DVD discs.

Dolby Digital EX

This technology enables 6.1-channel playback for sources encoded in the Dolby Digital EX format. It takes the Dolby Digital 5.1-channel setup one step further with an additional back surround channel.

Dolby Digital Plus

This is a compressed audio format for 7.1 channels developed by Dolby Laboratories. It is fully compatible with Dolby Digital and is available for playback on Dolby Digital-enabled audio systems. It is widely used with Blu-ray Discs.

Dolby Surround

This surround sound technology was developed by Dolby Laboratories to extend 2- to 7.1-channel content in accordance with audio systems used for playback. It not only enables playback of Dolby Atmos content but also extends traditional audio content to surround sound, including height channel audio, for 3D surround sound playback.

Dolby TrueHD

This advanced lossless audio technology was developed by Dolby Laboratories for high-definition disc-based media to deliver sounds that are identical, bit for bit, to studio masters for a great home theater experience. It delivers up to 8 discrete channels of 24-bit/96-kHz (up to 6 discrete channels of 24-bit/192 kHz) audio simultaneously, and is widely used with Blu-ray Discs.

DTS Digital Surround

This is a compressed audio format for 5.1 channels developed by DTS. It is widely used with DVD discs.

DTS Express

This is a compressed audio format for 5.1 channels. It provides a higher compression ratio than the DTS Digital Surround audio format, and was developed specifically for network streaming and Blu-ray Disc secondary audio.

DTS-HD High Resolution Audio

This is a compressed audio format for 24-bit/96-kHz superior sound quality with 7.1 channels developed by DTS. It is fully compatible with DTS Digital Surround, and is widely used with Blu-ray Discs.

DTS-HD Master Audio

This advanced lossless audio technology was developed by DTS for high-definition disc-based media to deliver sounds identical, bit for bit, to studio masters for a great home theater experience. It delivers up to 8 discrete channels at 24-bit/96 kHz (up to 6 discrete channels at 24-bit/192 kHz) audio simultaneously, and is widely used with Blu-ray Discs.

DTS Neo:6

This technology enables discrete 6-channel playback from 2-channel sources. There are two modes available: "Music mode" for music sources and "Cinema mode" for movie sources. It provides a channel split effect similar to sources recorded as discrete surround sound.

DTS:X

DTS:X is the next generation object-based, multi-dimensional audio technology from DTS.

Unbound from channels, DTS:X conveys the fluid movement of sound to create an incredibly rich, realistic and immersive soundscape - in front of, behind, beside and above the audience - more accurately than ever before. DTS:X offers the ability to automatically adapt the audio to the speaker layout that best fits the space, from a television's built-in speakers to a home surround theater system to a dozen or more speakers in a commercial cinema.

Immerse yourself at www.dts.com/dtsx

HDMI

High-Definition Multimedia Interface (HDMI) is a digital audio/video interface that has become an industry standard around the world. It is capable of transmitting both digital video and audio signals intact via a single cable. It is also compliant with the High-bandwidth Digital Content Protection (HDCP) standard. See <http://www.hdmi.org> for more information.

Neural:X

Neural:X is the latest downmixing / upmixing and spatial remapping technology from DTS.

It is built in to DTS:X to provide upmix of Neural:X-encoded and non-encoded (PCM) data.

In DTS:X for AVRs and Sound Bars, Neural:X can produce up to 11.x channels.

Pulse Code Modulation (PCM)

This technology records analog audio signals in digital form, converts analog audio signals to digital audio signals, and transmits analog audio signals in digital form. It is the underlying technology for all digital audio signal systems, and is widely used with CDs, Blu-ray Discs, and many other types of media as a uncompressed audio format known as Linear PCM.

x.v.Color

This is a color space supported by HDMI. It has become an international standard for video and offers a broader gamut than does the sRGB standard for expression of colors never before possible. It expands the color space while ensuring compatibility with the sRGB standard for more natural and vivid images.

Network information

SSID

SSID (Service Set Identifier) is a name that identifies a particular wireless LAN access point.

Wi-Fi

Wi-Fi is a technology that allows an electronic device to exchange data or connect to the Internet wirelessly using radio waves. Wi-Fi offers the advantage of eliminating the complexity of making connections with network cables by using wireless connection. Only products that complete Wi-Fi Alliance interoperability tests can carry the "Wi-Fi Certified" trademark.

WPS

WPS (Wi-Fi Protected Setup) is a standard established by the Wi-Fi Alliance, which allows easy establishment of a wireless home network.

Specifications

YSP-5600

Amplifier section

- Rated Output Power
Array speaker (1 kHz, 1% THD, 4 Ω) 74.8 W
Woofer (100 Hz, 1% THD 4 Ω) 17 W + 17 W
- Maximum Effective Output Power
Array speaker (1 kHz, 10% THD, 4 Ω) 88 W
Woofer (100 Hz, 10% THD 4 Ω) 20 W + 20 W

Speaker section

- Array speaker for Vertical Sound Beam
Type: Acoustic suspension type
Driver: 2.8 cm (1-1/8 in) cone magnetic shielding type 6 x 2 (L/R)
Impedance: 4 Ω
- Array speaker for Horizontal Sound Beam
Type: Acoustic suspension type
Driver: 4.0 cm (1-1/2 in) cone magnetic shielding type x 32
Impedance: 4 Ω
- Woofer
Type: Acoustic suspension type
Driver: 11 cm (4-1/2 in) cone non-magnetic shielding type x 2
Impedance: 4 Ω

Input jacks

- Audio Input
Optical 2 (TV, OPTICAL)
Coaxial 1 (AUX2)
Analog 1 pair (AUX1)
- HDMI Input 4 (HDMI IN 1 to 4)

Output jacks

- HDMI output (ARC) 1
- Subwoofer output 1

Other jacks

- INTELLIBEAM MIC 1
- SYSTEM CONNECTOR 1
- NETWORK 1
- UPDATE ONLY 1
- IR IN 1
- IR OUT 1
- RS-232C 1

Network

- Ethernet standard: 100BASE-T/10BASE-T
- Compatible with DLNA ver. 1.5
- Supported codecs
WAV (PCM format only) /AIFF/FLAC: up to 192 kHz
ALAC: up to 96 kHz
MP3/WMA/MPEG-4 AAC: up to 48 kHz
- AirPlay supported
- Internet Radio

Wireless LAN (Wi-Fi)

- Wireless LAN Standards IEEE802.11b/g/n
- Radio Frequency Band 2.4 GHz
- WPS (Wi-Fi Protected Setup)
..... Push-Button-Method, PIN Method
- Security Type WEP, WPA2-PSK (AES), Mixed Mode

Wireless LAN (Wireless Direct)

- Direct connection with mobile devices

Bluetooth

- Bluetooth version Ver. 2.1 +EDR
- Supported protocols
Receiving: A2DP, AVRCP
Transmitting: A2DP

- Supported codecs
Receiving: SBC, MPEG-4 AAC
Transmitting: SBC
- Wireless output Bluetooth Class 2
- Maximum communication distance
..... 10 m ([33 ft] without obstructions)
- Supported content protection method SCMS-T (receiving)

General

- Power Supply
[U.S.A. and Canada models] AC 120 V, 60 Hz
[Taiwan model] AC 110–120 V, 50/60 Hz
[China model] AC 220 V, 50 Hz
[Other models] AC 220–240 V, 50/60 Hz
- Power Consumption
[U.S.A. and Canada models] 68 W
[Other models] 50 W
- Standby Power Consumption
HDMI Control Off, Network Standby Off 0.3 W
HDMI Control On, Network Standby Off 1.6 W
HDMI Control Off, Network Standby On
(Wired/Wi-Fi/Wireless Direct/Bluetooth) 1.5/1.6/1.7/1.6 W
HDMI Control On, Network Standby On 3.1 W
- Dimensions (W x H x D)
Without Stands
..... 1100 x 212 x 93 mm (43-1/4 x 8-3/8 x 3-5/8 in)
With Stands ... 1100 x 216 x 122 mm (43-1/4 x 8-1/2 x 4-3/4 in)
- Weight 11.7 kg (25.8 lbs)

Specifications are subject to change without notice.

HDMI signal

• Audio signals

Audio signal types	Audio signal formats	Compatible media
2ch Linear PCM	2ch, 32–192 kHz, 16/20/24 bit	CD, DVD-Video, DVD-Audio, etc.
Multi-ch Linear PCM	8ch, 32–192 kHz, 16/20/24 bit	DVD-Audio, Blu-ray disc, HD DVD, etc.
Bitstream (SD Audio)	Dolby Digital, DTS	DVD-Video, etc.
Bitstream (HD Audio)	Dolby Atmos, Dolby TrueHD, Dolby Digital Plus, DTS:X*, DTS-HD Master Audio, DTS-HD High Resolution Audio, DTS Express	Blu-ray disc, HD DVD

* DTS:X may be provided with a firmware update.



- Refer to documentation supplied with the playback device, and set the device appropriately.
- When CPPM copy-protected DVD-Audio is played back, video and audio signals may not be output depending on the type of the DVD player.
- This unit is not compatible with HDCP-incompatible HDMI or DVI devices. Refer to documentation supplied with the HDMI or DVI device for HDCP compatibility.
- To decode audio bitstream signals on this unit, set the input source device appropriately so that the device outputs the bitstream audio signals directly (does not decode the bitstream signals on the device). Refer to documentation supplied with the device for details.

• Video signals

This unit is compatible with the following video signals.

- Deep Color
- x.v.Color
- 3D video signal

This unit is compatible with the following resolutions.

- VGA
- 480i/60 Hz
- 480p/60 Hz
- 576i/50 Hz
- 576p/50 Hz
- 720p/60 Hz, 50 Hz
- 1080i/60 Hz, 50 Hz
- 1080p/60 Hz, 50 Hz, 30 Hz, 25 Hz, 24 Hz
- 4K/60 Hz, 50 Hz, 30 Hz, 25 Hz, 24 Hz



- The resolution of transmitted video signal varies according to specifications of the TV connected to this unit.

Digital audio signal

• Optical/coaxial

Audio signal types	Audio signal formats	Compatible media
2ch Linear PCM	2ch, 32–96 kHz, 16/20/24 bit	CD, DVD-Video, DVD-Audio, etc.
Bitstream	Dolby Digital, Dolby Digital Surround EX, DTS, DTS-ES	DVD-Video, etc.

• HDMI (ARC)

Audio signal types	Audio signal formats	Compatible media
2ch Linear PCM	2ch, 32–192 kHz, 16/20/24 bit	TV
Bitstream	Dolby Digital Plus, Dolby Digital, DTS	TV

IntelliBeam

The "IntelliBeam" logo and "IntelliBeam" are trademarks of Yamaha Corporation.



The "CINEMA DSP" logo and "Cinema DSP" are registered trademarks of Yamaha Corporation.



Manufactured under license from Dolby Laboratories. Dolby, Dolby Atmos, Dolby Surround, Surround EX and the double-D symbol are trademarks of Dolby Laboratories.



For DTS patents, see <http://patents.dts.com>. Manufactured under license from DTS, Inc. DTS, the Symbol, DTS in combination with the Symbol, DTS:X, and the DTS:X logo are registered trademarks or trademarks of DTS, Inc. in the United States and/or other countries. © DTS, Inc. All Rights Reserved.

HDMI

"HDMI," the "HDMI" logo and "High-Definition Multimedia Interface" are trademarks, or registered trademarks of HDMI Licensing LLC.

x.v.Color

"x.v.Color" is a trademark of Sony Corporation.



The *Bluetooth*® word mark and logos are registered trademarks owned by *Bluetooth* SIG, Inc. and any use of such marks by Yamaha Corporation is under license.

Bluetooth

Bluetooth is a technology for wireless communication employing the 2.4 GHz frequency band, which can be used without a license.

Handling *Bluetooth* communications

- The 2.4 GHz band used by *Bluetooth* compatible devices is a radio band shared by many types of equipment. While *Bluetooth* compatible devices use a technology minimizing the influence of other components using the same radio band, such influence may reduce the speed or distance of communications and in some cases interrupt communications.
- The speed of signal transfer and the distance at which communications is possible differs according to the distance between the communicating devices, the presence of obstacles, radio wave conditions and type of equipment.
- Yamaha does not guarantee all wireless connections between this unit and devices compatible with *Bluetooth* function.

Apple

iTunes, Mac, AirPlay, iPad, iPhone, iPod, and iPod touch are trademarks of Apple Inc., registered in the U.S. and other countries.



MusicCast is a trademark or registered trademark of Yamaha Corporation.



DLNA™ and DLNA CERTIFIED™ are trademarks or registered trademarks of Digital Living Network Alliance. All rights reserved. Unauthorized use is strictly prohibited.

Windows™

Windows is a registered trademark of Microsoft Corporation in the United States and other countries.

Internet Explorer, Windows Media Audio and Windows Media Player are either registered trademarks or trademarks of Microsoft Corporation in the United States and/or other countries.

Android™

Android and Google Play are trademarks of Google Inc.



The Wi-Fi CERTIFIED Logo is a certification mark of Wi-Fi Alliance. The Wi-Fi Protected Setup Identifier Mark is a certification mark of Wi-Fi Alliance.

Wi-Fi, Wi-Fi Alliance, Wi-Fi CERTIFIED, Wi-Fi Protected Setup, WPA and WPA2 are trademark or registered trademark of Wi-Fi Alliance.

"Blu-ray Disc™", "Blu-ray™", and the logos are trademarks of the Blue-ray Disc Association

Explanations regarding GPL

This product utilizes GPL/LGPL open-source software in some sections. You have the right to obtain, duplicate, modify, and redistribute this open-source code only. For information on GPL/LGPL open source software, how to obtain it, and the GPL/LGPL license, refer to the Yamaha Corporation website (<http://download.yamaha.com/sourcecodes/musiccast/>).

Bluetooth protocol stack (Blue SDK)

Copyright 1999-2014 OpenSynergy GmbH
All rights reserved. All unpublished rights reserved.

Index

Numerics

- 2-channel playback 40
- 3D surround 5
- 3D surround sound playback 37
- 3D video 22
- 4K video 22

A

- Access point scan 53
- Adaptive DRC 74
- ADVANCED 85
- Advanced setup menu 85
- AirPlay 63
- Audio Assign 84
- Audio Delay 84
- Audio Return Channel (ARC) 22
- Audio signal information 78
- AUTO POWER STANDBY 86
- Auto setup (IntelliBeam) 29

B

- Bass 84
- Beam optimize only 32
- Beam Travel Length 70
- Beam+Sound optimize 32
- Bluetooth* 45
- Bluetooth* (receiving audio) 46
- Bluetooth* (transmitting audio) 48
- Bluetooth* settings 82
- Bracket 17
- Brightness adjustment (front panel display and indicators) 77

C

- Cardboard microphone stand 29

- Channel level 42
- Channel Out 72
- Channel output level adjustment (test sound) 74
- CINEMA DSP 102
- CINEMA DSP 3D 102
- CLEAR VOICE 41
- Compressed Music Enhancer 41

D

- Deep Color 103
- Default gateway 79, 80
- DHCP 50, 80
- Dialog position 41
- Digital Sound Projector 101
- Dimmer 77
- Distance Unit 77
- DLNA 60
- DNS server (P) 79, 80
- DNS server (S) 79, 80
- Dolby Atmos 103
- Dolby Digital 103
- Dolby Digital EX 103
- Dolby Digital Plus 103
- Dolby Surround 103
- Dolby TrueHD 103
- DTS 75
- DTS Digital Surround 103
- DTS Express 103
- DTS Neo:6 103
- DTS:X 75, 104
- DTS-HD High Resolution Audio 103
- DTS-HD Master Audio 103
- Dynamic Range 75

E

- Eco function 43

- Encryption method 53, 55, 57, 58
- Entertainment 39
- Error buzzer 31
- Error message 33

F

- File format (computers/NAS) 60
- Firmware of this unit 78, 86
- Firmware update 81, 87
- Front panel 8

H

- HDCP version 2.2 22
- HDMI 104
- HDMI audio assignment 84
- HDMI Audio Out 76
- HDMI cable 22, 23
- HDMI control 34, 76
- Height channels 37, 101
- HOME THEATER CONTROLLER (WLAN) app 5

I

- Installing the unit 12
- IntelliBeam 29
- INTELLIBEAM MIC jack 8
- IntelliBeam microphone 29
- Internet radio 61
- IP address 79, 80
- iPod music (AirPlay) 63
- iTunes music (AirPlay) 63

L

- Language (OSD) 28
- Language for menu display 77

M

MAC address 79
MAC address filter 50, 80
Manual setting (wireless connection) 55
Media sharing setup 60
Menu screen 27
Mobile device music 65
Mounting the unit on a wall 17
Movie 39
MP3 41
Music 39
MusicCast CONTROLLER app 5

N

Network information 79
Network name 81
Network standby 81
Neural:X 75, 104

O

Option menu 83
OSD Language 77
Output timing adjustment (image and sound) 84

P

Power cable 26
Pulse Code Modulation (PCM) 104

R

Rear panel 9
Reflection board 99
Remote control 7, 10
Remote control sensor 8

S

Sampling frequency 78
Security 79

Security key 56, 58
Security software 50
Setup menu 66
Sharing Wi-Fi settings (iOS device) 28, 52
Sound optimize only 32
SSID 53, 54, 79, 104
Stands 16
STATUS indicator 8
Stereo playback 40
Subnet mask 50, 79
Subwoofer settings 73
Subwoofer volume 36
Surround sound 38
System memory 44

T

Target playback mode 40
Test sound 74
Tone adjustment 84
Top panel 8
Treble 84
TV 27, 34
TV audio input 76

V

Video signal information 78
Volume 36
Volume Trim 84
vTuner 61
vTuner ID 79

W

Wi-Fi 104
Wired network connections 25, 51
Wireless Direct 58
Wireless network 51
Wireless subwoofer kit 25
WMA 60

WPS 104
WPS PIN code 57

X

x.v.Color 104



YAMAHA CORPORATION

© 2015 Yamaha Corporation YH433A0/EN1